

AXIAL FANS AND ROOF-MOUNTED EXTRACT FANS





SODECA has focused its business activity on the manufacture of industrial fans, ventilation systems and smoke exhaust fans for fire protection since it was set up in 1983.

The fans and extract fans manufactured by Sodeca are present in Europe and in many other parts of the world due to their quality and the research and development methods used. Our quality procedures, certified by BUREAU VERITAS in accordance with ISO 9001:2015, are another reason why SODECA is positioned as one of the best and most recognised fan manufacturer in Europe.

There is no doubt that the most important element in achieving our objectives is the human factor and the professionals who work in the company and offer not only ventilation equipment but solutions to all the needs of our customers in the ventilation sector. We offer them the option of visiting our facilities in Sant Quirze de Besora, with a developed surface area of more than 16,000 m², to see our fan production plant, which complies with the highest quality requirements and with the ISO and AMCA standards.

This catalogue contains just a few of all the options we offer. Please contact us and we will place all our experience and staff at your disposal.

AXIAL FANS

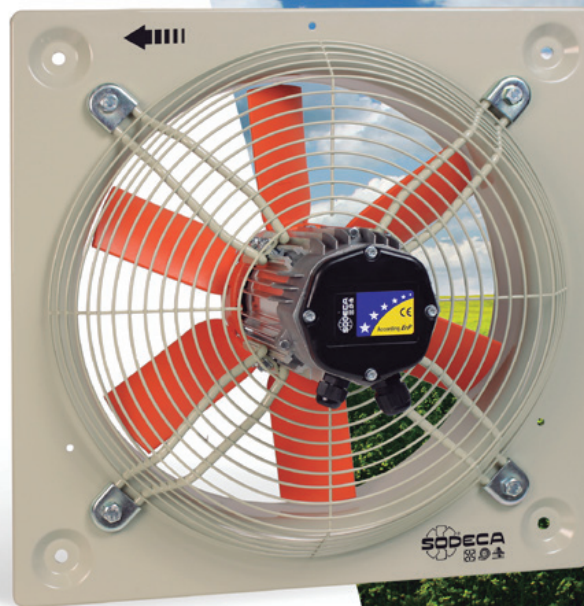

Since it was first established, Sodeca has specialised in the design and manufacture of fans and their accessories for industrial applications.

The combination of its experience gained over decades of working with fans and the technology provided by the engineers employed in its different departments has allowed Sodeca to occupy a leading international position as a fan manufacturer.

Industrial applications require an important capacity to adapt to the specifications of each project and flexibility in production in order to comply with the real needs of each client.

To comply with this objective, Sodeca has a standard products line and a specially-manufactured products line for building fans that meet the demands of our clients.

For many years, we have constantly invested in the development of processes and applications aimed

at manufacturing and supplying special industrial fans with extremely tight deadlines in terms of their design and production.

The teamwork of our engineering department, in conjunction with universities and technological centres, and the close cooperation between the design departments of our external partners has made it possible to obtain new industrial fan solutions in a very short space of time.

During our history, we have developed all manner of fan technology for industrial applications in all parts of the world. Our aim is to continue to invest in this sector in order to become one of the most reputed global industrial fan manufacturers.

EXTRACT SYSTEMS WITH ROOF-MOUNTED EXTRACT FANS

SAFETY IN THE EVENT OF FIRE

The fire protection standards make it obligatory to apply temperature control and smoke extraction systems in accordance with standard UNE / EN-23585, calculation and design requirements and methods for planning a temperature control and smoke extraction system in the event of fire. To provide a solution to the needs established by this standard, approved roof-mounted fans exist for this purpose, pursuant to standard EN-12101-3 with an F-400 (400°C/2h) or F-300 (300°C/2h) certificate.

COMFORT AND NOISE REDUCTION

A working environment with the appropriate conditions of comfort is absolutely necessary to ensure an efficient job performance. The installation of outdoor fans brings greater comfort to work zones, reducing noise and the occupation of space in industrial buildings.

REDUCTION IN HEAT AND MOISTURE

The hot air generated by indoor activity and heating of the roof due to solar radiation transform the ceilings of industrial buildings into huge radiators that give off heat, which is transferred to work areas, increasing the temperature and the electricity bill due to a greater need for cooling. Furthermore, in colder climates, condensation increases the moisture level, saturating the insulation material of roofs and reducing their efficiency. A good ventilation system helps prevent all these effects which are harmful to the building structure and to people's health.

MAINTENANCE AND CLEANING

It is very important for roof-mounted fans to be easy to clean, as they are very difficult to access. The maintenance of all the extract system elements is essential and very important to achieve a high standard of cleaning and obtain the required grade of hygiene in each installation, thus preventing the possibility of handling contaminated air particles. Ease in the maintenance and installation of roof equipment leads to important cost savings, which is a factor to be considered.



COMPLIANCE WITH STANDARDS

SODECA fans and extract fans comply with the following standards:

COMPLIANCE

ISO 9001:2015	Sistemas de gestión de la calidad. Requisitos. Quality management systems -- Requirements.
----------------------	---

TESTING

UNE-EN ISO 5801	Ventiladores industriales. Ensayos de comportamiento en circuitos normalizados. Industrial fans -- Performance testing using standardized airways.
AMCA 210-16	Ventiladores industriales. Métodos de ensayos de ventiladores y su representación de ensayos. Laboratory Methods of Testing Fans for Aerodynamic Performance Rating.
UNE-EN ISO 13350	Ventiladores industriales. Ensayos de comportamiento de ventiladores de chorro. Industrial fans -- Performance testing of jet fans.
ISO 13348	Industrial fans -- Tolerances, methods of conversion and technical data presentation.

HIGH TEMPERATURE FANS

UNE EN 12101-3	Sistemas de control de humos y calor. Parte 3: Especificaciones para aireadores extractores de humos y calor mecánicos. Smoke and heat control systems - Part 3: Specification for powered smoke and heat exhaust ventilators.
-----------------------	---

ACOUSTICS

UNE EN ISO 3744	Acústica. Determinación de los niveles de potencia acústica de fuentes de ruido a partir de la presión acústica. Método de ingeniería para condiciones de campo libre sobre un plano reflectante. Acoustics -- Determination of sound power levels of noise sources using sound pressure -- Engineering method in an essentially free field over a reflecting plane.
------------------------	--

BALANCING AND VIBRATIONS

ISO 21940-11	Vibraciones mecánicas. Calidad de equilibrado. Mechanical vibration – rotor balancing - Part 11: Procedures and tolerances for rotors with rigid behaviour.
ISO 20816-1	Vibraciones mecánicas. Evaluación de las vibraciones de máquinas. Mechanical vibration – measurement and evaluation of machine vibration – Part 1: General guidelines.
ISO 14694	Ventiladores industriales. Especificaciones para equilibrado y niveles de vibración. Industrial fans -- Specifications for balance quality and vibration levels.

SAFETY (EC Declaration of Conformity)

UNE EN ISO 12100	Seguridad de las máquinas. Principios generales para el diseño. Evaluación del riesgo y reducción del riesgo. Safety of machinery – General principles for design - Risk assessment and risk reduction.
UNE EN 60204-1	Seguridad de las máquinas. Equipo eléctrico de las máquinas. Parte 1: Requisitos generales. Safety of machinery - Electrical equipment of machines - Part 1: General requirements.
UNE EN ISO 13857	Seguridad de máquinas. Distancias de seguridad para impedir que se alcancen zonas peligrosas con los miembros superiores e inferiores. Safety of machinery -- Safety distances to prevent danger zones being reached by upper and lower limbs.
UNE-EN ISO 12499	Ventiladores industriales. Seguridad mecánica de los ventiladores. Protección. Industrial fans -- Mechanical safety of fans -- Guarding.

DIRECTIVES AND REGULATIONS

Directive 2006/42/EC	Directiva de máquinas. Machinery Directive.	Regulation 305/2011	Condiciones armonizadas para la comercialización de productos de construcción. Harmonised conditions for the marketing of construction products.
Directive 2014/35/EU	Directiva de baja tensión. Low Voltage Directive.	Directive 2009/125/EC	Directiva de requisitos de diseño ecológico para productos que utilizan energía. Ecodesign Requirements for Energy-related Products Directive.
Directive 2014/30/EU	Directiva compatibilidad electromagnética. EMC Directive.		

ATEX EXECUTIONS

Directive ATEX 2014/34/EU	Aparatos y sistemas de protección para uso en atmósferas potencialmente explosivas. Equipment and protective systems intended for use in potentially explosive atmospheres.
UNE EN 14986	Diseño de ventiladores para trabajar en atmósferas potencialmente explosivas. Design of fans working in potentially explosive atmospheres.
UNE EN 13463-1	Equipos no eléctricos destinados a atmósferas potencialmente explosivas. Parte 1: Requisitos y metodología básica. Non-electrical equipment for use in potentially explosive atmospheres - Part 1: Basic method and requirements.
UNE EN 1127-1	Atmósferas explosivas. Prevención y protección contra la explosión. Parte 1: Conceptos básicos y metodología. Explosive atmospheres - Explosion prevention and protection - Part 1: Basic concepts and methodology.

AXIAL FANS

8 HEP
Wall-mounted axial fans with IP65 motors.



8 HEPT
Wall-mounted axial fans with IP65 motors.



12 HC
Wall-mounted axial fans with IP55 motors.



17 HCD
Wall-mounted axial fans with small diameters.



19 HRE
Circular axial fans with external rotor motors.



19 HCRE
Wall-mounted axial fans with low-noise sheet steel impellers.



22 HCH HCT
Extremely robust wall-mounted or tubular axial fans.



28 HFW
Hot dip galvanised tubular fans.



33 HCT/IMP
Long range, one-way or reversible jet fans.



36 HCT/IMP-C
Long-range, circular, one-way or reversible jet fans.

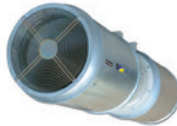

38 CJHCH
Axial ventilation units with acoustically-isolated boxes.



40 HTP
High pressure tubular axial extract fans.



54 HGT
Large diameter tubular axial fans with direct drive motors.



54 HGTX
Large diameter tubular axial fans with direct drive motors.



73 HTM
Tubular mobile axial fans.



75 HPX
Tubular axial fans with external motors.



78 HBA
Forked tubular axial fans with motors outside the air flow.



80 HPX/SEC
Fans designed to work in kilns, drying barns and other applications with high temperatures and humidity.



87 HCH/SEC
Fans designed for use in extreme working conditions in ceramic and wood drying kilns.



89 HGI
Axial fans with large diameters for farms.



ROOF-MOUNTED FANS

91 HT
Roof-mounted axial extract fans with flat bases.

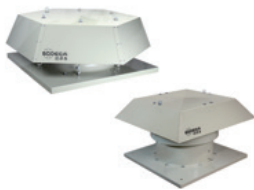

94 HTMH
Roof-mounted multifunctional extract fans for large flow rates.

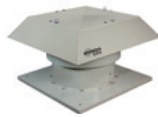

100 HTMF
400°C/2h and 300°C/2h roof-mounted multifunctional extract fans.

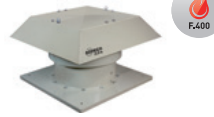

106 HTMV
Roof-mounted axial extract fans with vertical air outlets.



109 THT/ROOF
400°C/2h and 300°C/2h roof-mounted axial extract fans with vertical air outlets.



134 HTTI
Roof-mounted axial extract fans with inclined supports, depending on the roof inclination.



136 THT/HATCH
400°C/2h and 300°C/2h-rated dynamic discharge systems with motorised opening function, for smoke extraction in the event of fire.



141 CRF
Centrifugal roof-mounted extract fans with low noise levels.

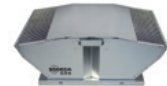

144 CRF/EW/CPC
Centrifugal roof-mounted extract fans fitted with E.C. Technology external rotor motor and constant pressure control.



149 CHT CVT
400°C/2h centrifugal roof-mounted extract fans, with horizontal or vertical air outlets.



153 CTD
Centrifugal roof-mounted extract fans for household ventilation.



155 TIRACANO
Chimney smoke extract fans.



156 RCH
RCH 400x800VM
Chimney extract fan and cap for hybrid extraction in community housing.



HEP HEPT



HEP: Wall-mounted axial fans with IP65 motors

HEPT: Tubular axial fans with IP65 motors



HEP



HEPT

Wall-mounted axial (HEP) and tubular (HEPT) fans with reinforced plastic impeller made of fibreglass.

Fan:

- Airflow direction from motor to impeller.
- Fibreglass-reinforced polyamide-6 impeller.
- HEP: Sheet steel support frame.
- HEP: Anti-contact protective grille pursuant to standard UNE-EN ISO 12499.
- HEPT: Sheet steel tubular casing.
- HEPT: External junction box, IP65 protection.

Motor:

- Class F motors with ball bearings and IP65 protection.
- Single-phase 220-240V -50Hz, and three-phase 240V/380-415V-50Hz.
- Operating temperature: -25°C +60°C, 4-6-8-pole motors and -25°C +45°C, 2-pole motors.

Finish:

- Anti-corrosive finish of polyester resin polymerised at 190°C, previously degreased with phosphate-free nanotechnological treatment.

On request:

- Motor, impeller and grille assembly (version F).
- Impeller motor unit (version G).
- Airflow direction from impeller to motor.
- Special windings for different voltages.

Order code

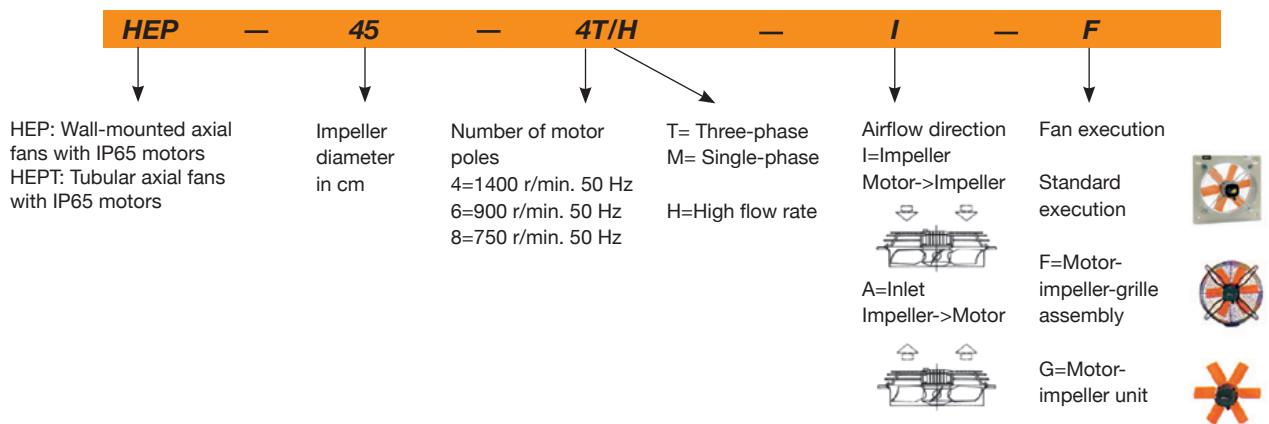

Technical characteristics

Model	Speed (r/min)	Maximum admissible current (A)		Power absorb. free discharge (W)	Maximum flow rate (m³/h)	Noise level dB(A)	Approx. weight (kg)		According to ErP
		220-240V	380-415V				HEP	HEPT	
HEP-25-2T/H -	2780	1.30	0.75	265	2300	64	5.3	-	2015
HEP-25-2M/H -	2750	1.95	-	345	2300	64	5.3	-	2015
HEP-25-4T/H -	1450	0.69	0.40	85	1250	52	4.5	-	Excluded
HEP-25-4M/H -	1440	0.65	-	95	1250	52	4.5	-	Excluded
HEP-31-2T/H HEPT-31-2T/H	2640	1.54	0.89	400	4000	74	7.0	7.4	2015
HEP-31-2M/H HEPT-31-2M/H	2640	2.30	-	410	4000	74	7.0	7.4	2015
HEP-31-4T/H HEPT-31-4T/H	1410	0.69	0.40	115	2400	55	5.7	6.2	Excluded
HEP-31-4M/H HEPT-31-4M/H	1410	0.75	-	130	2400	55	5.7	6.2	Excluded
HEP-35-2T/H HEPT-35-2T/H	2790	2.16	1.25	550	6020	76	8.8	9.4	2015
HEP-35-2M/H HEPT-35-2M/H	2675	2.80	-	560	6020	76	8.8	9.4	2015
HEP-35-4T/H HEPT-35-4T/H	1340	0.74	0.43	155	3500	58	7.1	7.6	2015

Technical characteristics

Model	Speed (r/min)	Maximum admissible current (A)		Power absorb. free discharge (W)	Maximum flow rate (m³/h)	Noise level dB(A)	Approx. weight (kg)		According to ErP	
		220-240V	380-415V				HEP	HEPT		
HEP-35-4M/H	HEPT-35-4M/H	1340	0.98	-	160	3500	58	7.1	7.6	2015
HEP-40-4T/H	HEPT-40-4T/H	1420	2.10	1.20	245	5200	61	10.6	13.5	2015
HEP-40-4M/H	HEPT-40-4M/H	1400	1.85	-	355	5200	61	10.6	13.5	2015
HEP-40-6T/H	HEPT-40-6T/H	960	1.12	0.65	155	3500	54	10.2	13.5	Excluded
HEP-40-6M/H	HEPT-40-6M/H	960	1.06	-	185	3500	54	10.2	13.5	Excluded
HEP-45-4T/H	HEPT-45-4T/H	1400	2.11	1.22	475	7300	66	12.5	15.5	2015
HEP-45-4M/H	HEPT-45-4M/H	1400	2.35	-	490	7300	66	12.5	15.5	2015
HEP-45-6T/H	HEPT-45-6T/H	955	1.42	0.82	215	4900	56	11.4	15.5	2015
HEP-45-6M/H	HEPT-45-6M/H	955	1.40	-	225	4900	56	11.4	15.5	Excluded
HEP-50-4T/H	HEPT-50-4T/H	1420	3.10	1.80	740	10150	69	15.0	18.0	2015
HEP-50-4M/H	HEPT-50-4M/H	1380	3.35	-	710	10150	69	15.0	18.0	2015
HEP-50-6T/H	HEPT-50-6T/H	950	1.38	0.80	205	6150	59	13.2	18.0	2015
HEP-50-6M/H	HEPT-50-6M/H	950	1.38	-	215	6150	59	13.2	18.0	2015
HEP-56-4T/H	HEPT-56-4T/H	1350	3.63	2.10	870	12800	72	21.0	28.0	2015
HEP-56-4M/H	HEPT-56-4M/H	1350	5.26	-	895	12800	72	21.0	28.0	2015
HEP-56-6T/H	HEPT-56-6T/H	915	1.73	1.00	325	8250	62	17.0	28.0	2015
HEP-56-6M/H	HEPT-56-6M/H	915	2.12	-	450	8250	62	17.0	28.0	2015
HEP-63-4T/H	HEPT-63-4T/H	1415	6.92	4.00	1400	18700	82	25.8	33.5	2015
HEP-63-6T/H	HEPT-63-6T/H	905	2.06	1.19	405	12050	65	20.2	33.5	2015
HEP-63-6M/H	HEPT-63-6M/H	905	2.70	-	540	12050	65	20.2	33.5	2015



Erp. (Energy Related Products)

Information on Directive 2009/125/EC can be downloaded from the SODECA website or the QuickFan selector programme.

Acoustic characteristics

The indicated values are determined by measuring the pressure and sound power levels in dB(A) obtained in a free field at a distance equivalent to twice the size of the fan plus the impeller diameter, with a minimum of 1.5 m.

Noise power spectrum Lw(A) in dB(A) frequency band in [Hz]

Model	63	125	250	500	1000	2000	4000	8000	Model	63	125	250	500	1000	2000	4000	8000
25-2/H	39	52	64	68	70	70	66	58	45-4/H	43	57	69	72	74	75	71	62
25-4/H	27	40	52	56	58	58	54	46	45-6/H	33	47	59	62	64	65	61	52
31-2/H	49	62	74	78	80	80	76	68	50-4/H	46	60	72	75	77	78	74	65
31-4/H	30	43	55	59	61	61	57	49	50-6/H	36	50	62	65	67	68	64	55
35-2/H	51	64	76	80	82	82	78	70	56-4/H	49	63	75	78	80	81	77	68
35-4/H	33	46	58	62	64	64	60	52	56-6/H	39	53	65	68	70	71	67	58
40-4/H	36	49	61	65	67	67	63	55	63-4/H	61	75	87	90	92	92	89	80
40-6/H	29	42	54	58	60	60	56	48	63-6/H	44	58	70	73	75	75	72	63

Dimensions mm

HEP

Model	A	B	ØC	ØD	2T	F	
						4T	6T
HEP-25	330	275	262	260	233	233	-
HEP-31.../H	400	336	310.5	308	229	229	-
HEP-35.../H	465	390	362.5	360	236	236	-
HEP-40.../H	532	452	412.5	410	-	273	305
HEP-45.../H	596	504	462.5	460	-	281	218
HEP-50.../H	665	562	516.5	514	-	302	254
HEP-56.../H	710	630	563	560	-	333	266
HEP-63.../H	800	710	638	635	-	340	276

Model	G	H	ØJ	K	L
HEP-25	11	56	8.5	310	M8
HEP-31.../H	11	65	8.5	380	M8
HEP-35.../H	11	76	10.5	450	M8
HEP-40.../H	11	97.5	10.5	500	M8
HEP-45.../H	11	105	10.5	560	M8
HEP-50.../H	11	115	10.5	640	M8
HEP-56.../H	15	115	10.5	721	M8
HEP-63.../H	16.5	140	10.5	820	M8

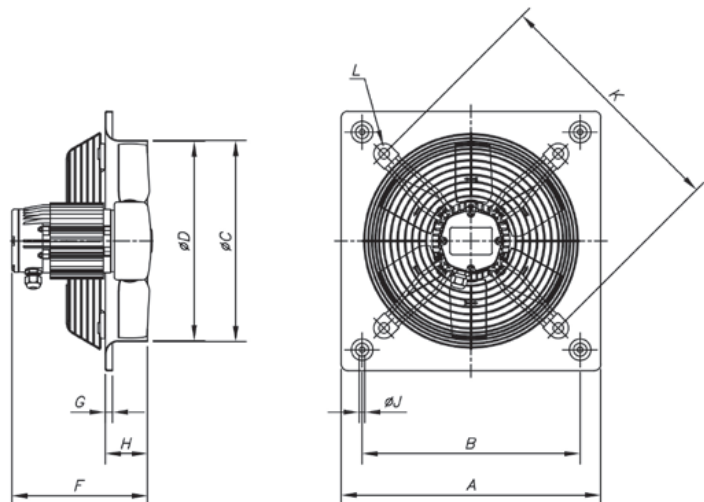

Dimensions mm

HEPT							
Model	øA	øB	øD	F	E	øJ	Number of holes
HEPT-31-2T	385	355	308	235.5	200	10	8
HEPT-31-2M	385	355	308	244.5	200	10	8
HEPT-31-4	385	355	308	225.5	200	10	8
HEPT-35-2	425	395	360	246.5	220	10	8
HEPT-35-4	425	395	360	227.5	220	10	8
HEPT-40	490	450	410	233.5	220	12	8
HEPT-45	540	500	460	233.5	220	12	8
HEPT-50-4	600	560	514	248	230	12	12
HEPT-50-6	600	560	514	230	230	12	12
HEPT-56	660	620	560	278	260	12	12
HEPT-63	730	690	635	350	350	12	12

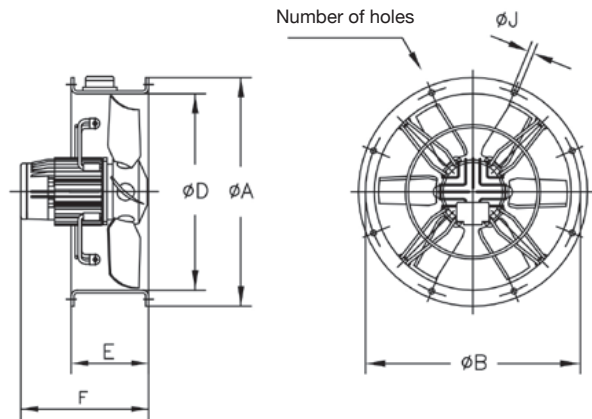

Characteristic curves

Q= Flow rate in m³/h, m³/s and cfm.

Pe= Static pressure in mm H₂O, Pa and inwg.

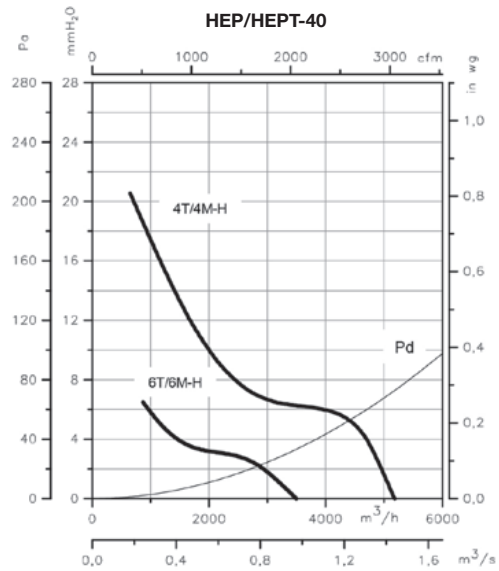
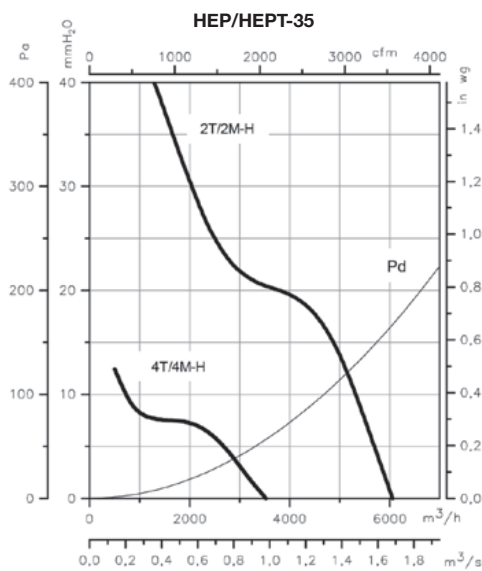
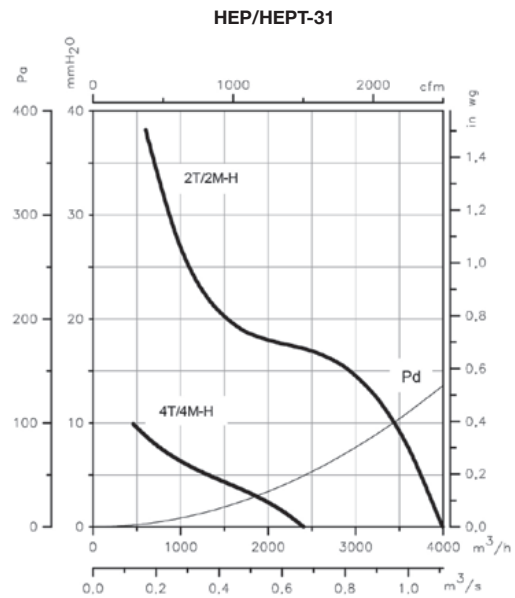
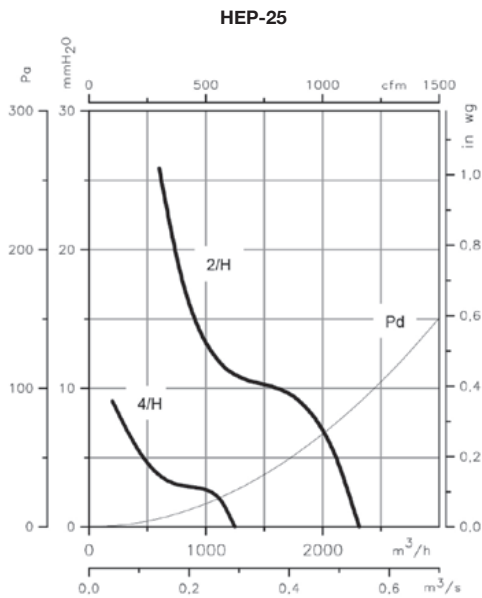

Characteristic curves

Q= Flow rate in m³/h, m³/s and cfm.

Pe= Static pressure in mm H₂O, Pa and inwg.

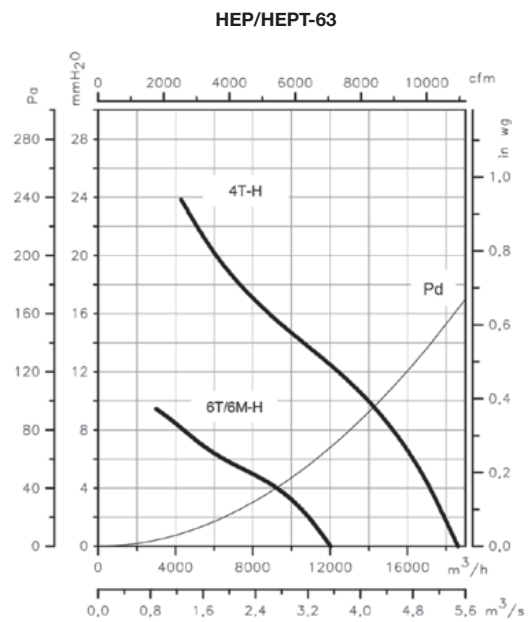
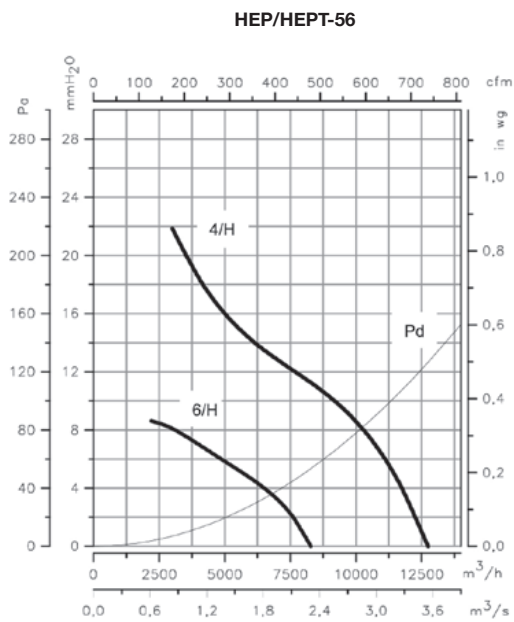
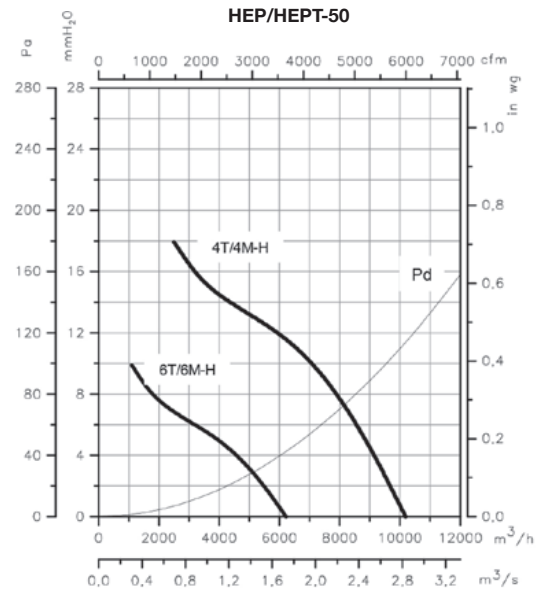
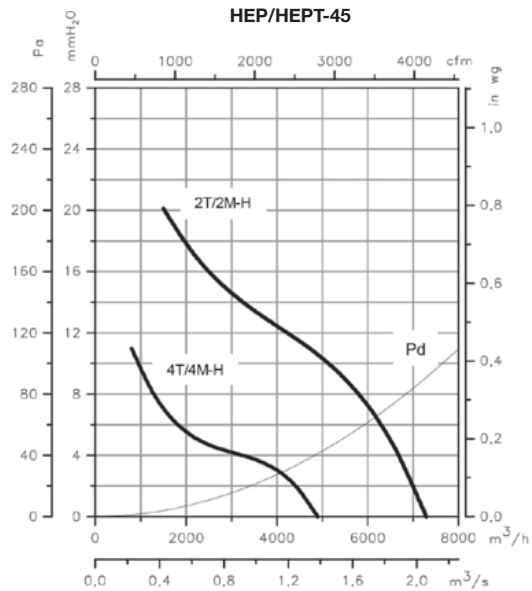

Accessories

See accessories section.



HC



Wall-mounted axial fans with IP55 motors



HC



HC 71, 80, 90, 100

Wall-mounted axial fans with reinforced plastic impeller made of fibreglass.

Fan:

- Sheet steel support frame.
- Fibreglass-reinforced polyamide-6 impeller.
- Anti-contact protective grille pursuant to standard UNE-EN ISO 12499.
- Models 71, 80, 90 and 100, protective grille supplied as an accessory
- Airflow direction from motor to impeller.

Motor:

- IE3 efficiency motors for powers equal to or higher than 0.75kW except single-phase, 2-speed and 8-pole.
- Class F motors with ball bearings, IP55 protection, except single-phase models from size 45 to size 63, IP54 protection. 1 or 2 speeds, depending on model

- Single-phase 230V-50Hz and three-phase 230/400V-50Hz (up to 4kW) and 400/690V 50Hz (powers higher than 4kW)
- Operating temperature: -25 °C +60 °C.

Finish:

- Anti-corrosive finish of polyester resin polymerised at 190°C, previously degreased with phosphate-free nanotechnological treatment.

On request:

- Motor, impeller and grille assembly (F version), except models 71, 80, 90 and 100, which are supplied without a grille.
- Motor impeller unit, version G.
- Airflow direction from impeller to motor.
- Special windings for different voltages.

Order code

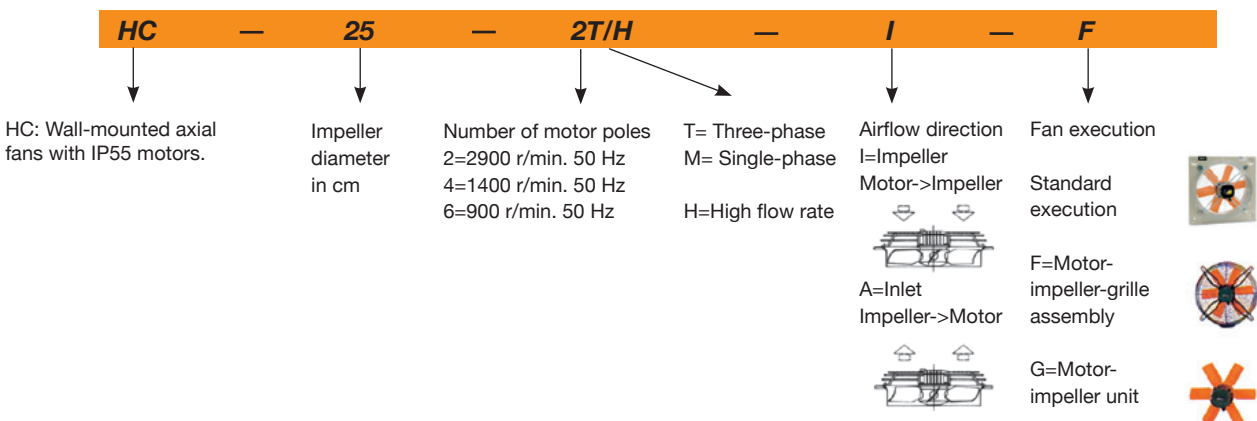

Technical characteristics

Model	Speed (r/min)	Maximum admissible current (A)			Installed power (kW)	Maximum flow rate (m³/h)	Sound pressure level dB(A)	Approx. weight (kg)	According to ErP
		230V	400V	690V					
HC-25-2T/H	2730	0.70	0.40	0.12	2200	64	5	2015	
HC-25-2M/H	2730	1.10		0.12	2200	64	5	*	
HC-25-4T/H	1350	1.10	0.60	0.09	1300	51	5	Excluded	
HC-25-4M/H	1350	1.10		0.09	1300	51	5	Excluded	
HC-31-2T/H	2750	1.21	0.70	0.18	3650	72	6	2015	

Technical characteristics

Model	Speed (r/min)	Maximum admissible current (A)			Installed power (kW)	Maximum flow rate (m³/h)	Sound pressure level dB(A)	Approx. weight (kg)	According to ErP
		230V	400V	690V					
HC-31-2M/H	2700	1.85			0.18	3600	72	6	2015
HC-31-4T/H	1350	1.10	0.60		0.09	2400	54	6	Excluded
HC-31-4M/H	1430	0.99			0.10	2400	54	6	Excluded
HC-35-2T/H	2710	1.92	1.11		0.37	6050	76	8	2015
HC-35-4T/H	1350	1.10	0.60		0.09	3550	58	7	2015
HC-35-4M/H	1440	1.08			0.10	3550	58	7	2015
HC-40-4T/H	1350	1.66	0.96		0.25	5200	63	10	2015
HC-40-4M/H	1370	2.00			0.25	5200	63	10	2015
HC-40-6T/H	900	1.51	0.87		0.25	3700	55	10	2015
HC-40-6M/H	970	1.30			0.25	3700	55	10	*
HC-45-4T/H	1370	2.02	1.17		0.37	7300	66	14	2015
HC-45-4M/H	1400	2.76			0.37	7300	66	14	2015
HC-45-6T/H	900	1.51	0.87		0.25	5150	57	14	2015
HC-45-6M/H	950	1.50			0.25	5150	57	14	2015
HC-50-4T/H	1380	2.92	1.69		0.55	10200	69	18	2015
HC-50-4M/H	1350	5.02			0.55	10200	69	18	2015
HC-50-6T/H	900	2.24	1.30		0.37	6300	59	18	2015
HC-50-6M/H	900	2.69			0.37	6300	59	18	*
HC-56-4T/H IE3	1455	4.07	2.34		1.10	13000	72	28	2015
HC-56-6T/H	900	2.24	1.30		0.37	8300	61	19	2015
HC-56-6M/H	900	2.69			0.37	8300	61	19	2015
HC-63-4T/H IE3	1455	4.07	2.34		1.10	16450	74	30	2015
HC-63-6T/H	900	2.24	1.30		0.37	12350	64	21	2015
HC-63-6M/H	890	3.00			0.37	12350	64	21	2015
HC-71-4T/H IE3	1440	5.41	3.11		1.50	22150	78	43	2015
HC-71-6T/H IE3	940	3.36	1.93		0.75	17300	66	39	2015
HC-71-6M/H	900	4.97			0.75	15600	65	36	2015
HC-80-4T/H IE3	1440	10.70	6.15		3.00	33000	82	60	2015
HC-80-6T/H IE3	940	3.36	1.93		0.75	22000	71	48	2015
HC-90-4T/H IE3	1450	13.90	8.00		4.00	43700	86	70	2015
HC-90-6T/H IE3	950	6.43	3.70		1.50	33300	76	64	2015
HC-100-4T/H IE3	1465		10.30	5.97	5.50	54000	88	108	2015
HC-100-6T/H IE3	950	6.43	3.70		1.50	37000	78	67	2015

* Equipment not covered by Directive 2009/125/EC



Erp. (Energy Related Products)

Information on Directive 2009/125/EC can be downloaded from the SODECA website or the QuickFan selector programme.

Acoustic characteristics

The indicated values are determined by measuring the pressure and sound power levels in dB(A) obtained in a free field at a distance equivalent to twice the size of the fan plus the impeller diameter, with a minimum of 1.5 m.

Noise power spectrum Lw(A) in dB(A) frequency band in [Hz]

Model	63	125	250	500	1000	2000	4000	8000	Model	63	125	250	500	1000	2000	4000	8000
25-2T/H	38	48	65	65	73	69	62	53	56-6T/H	28	45	58	65	70	71	66	59
25-4T/H	25	35	52	52	60	56	49	40	63-4T/H	43	60	73	80	85	86	81	74
31-2T/H	46	56	73	73	81	77	70	61	63-6T/H	33	50	63	70	75	76	71	64
31-4T/H	28	38	55	55	63	59	52	43	71-4T/H	47	64	77	84	89	90	85	78
35-2T/H	50	60	77	77	85	81	74	65	71-6T/H	35	52	65	72	77	78	73	66
35-4T/H	32	42	59	59	67	63	56	47	80-4T/H	60	81	88	93	96	92	85	74
40-4T/H	28	45	57	65	70	70	66	59	80-6T/H	49	70	77	82	85	81	74	63
40-6T/H	20	37	49	57	62	62	58	51	90-4T/H	64	85	92	97	100	96	89	78
45-4T/H	33	50	63	70	75	76	71	64	90-6T/H	54	75	82	87	90	86	79	68
45-6T/H	24	41	54	61	66	67	62	55	100-4T/H	68	88	96	101	103	100	93	82
50-4T/H	36	53	66	73	78	79	74	67	100-6T/H	58	78	86	91	93	90	83	72
50-6T/H	26	43	56	63	68	69	64	57									
56-4T/H	39	56	69	76	81	82	77	70									

Dimensions mm

HC-25...63

Model	A	B	ØC	ØD	E	G	H	ØJ	K
HC-25	330	275	262	260	241	11	56	8.5	310
HC-31-2	400	336	310.5	308	264.5	11	65	8.5	380
HC-31-4	400	336	310.5	308	245.5	11	65	8.5	380
HC-35-2	465	390	362.5	360	310	11	76	10.5	450
HC-35-4	465	390	362.5	360	261	11	76	10.5	450
HC-40-4.../H	532	452	412.5	410	332	11	97.5	10.5	500
HC-40-6.../H	532	452	412.5	410	332	11	97.5	10.5	500
HC-45-4.../H	596	504	462.5	460	339	11	105	10.5	560
HC-45-6.../H	596	504	462.5	460	339	11	105	10.5	560
HC-50-4T/H	665	562	516.5	514	376	11	115	10.5	640
HC-50-4M/H	665	562	516.5	514	376	11	115	10.5	640
HC-50-6.../H	665	562	516.5	514	336	11	115	10.5	640
HC-56-4T/H	710	630	563	560	374	15	115	10.5	721
HC-56-6.../H	710	630	563	560	351	15	115	10.5	721
HC-63-4T/H	800	710	638	635	399	15	140	10.5	820
HC-63-6.../H	800	710	638	635	376	15	140	10.5	820

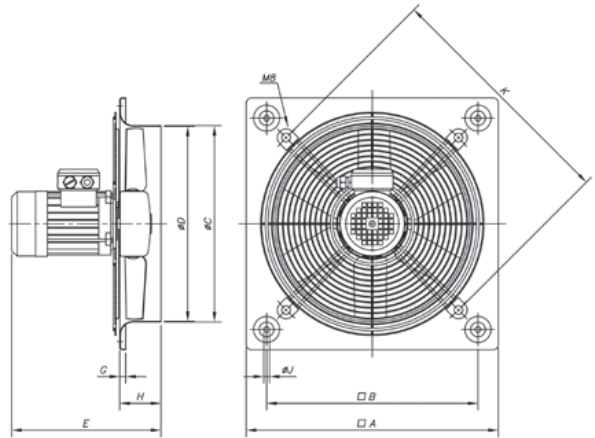

HC-71...100

Model	A	B	ØC	ØD	E	G	H	ØJ
HC-71-4T/H	850	810	714	710	395	20	150	14.5
HC-71-6T/H	850	810	714	710	395	20	150	14.5
HC-80-4T/H	970	910	804	800	500	20	180	14.5
HC-80-6T/H	970	910	804	800	458	20	180	14.5
HC-90-4T/H	1170	1110	904	900	511	20	180	14.5
HC-90-6T/H	1170	1110	904	900	500	20	180	14.5
HC-100-4T/H	1170	1110	1004	1000	548	20	180	14.5
HC-100-6T/H	1170	1110	1004	1000	498	20	180	14.5

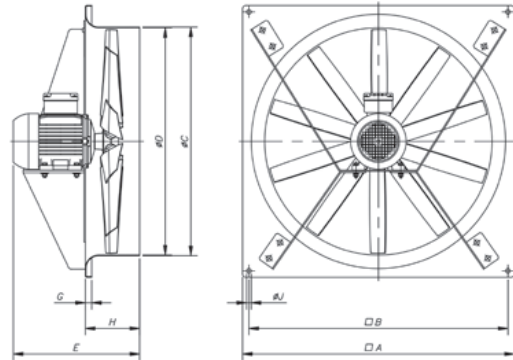

Characteristic curves

Q= Flow rate in m³/h, m³/s and cfm.

Pe= Static pressure in mm H₂O, Pa and inwg.

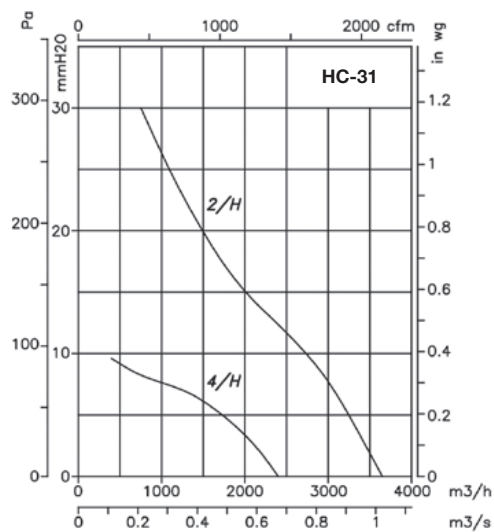
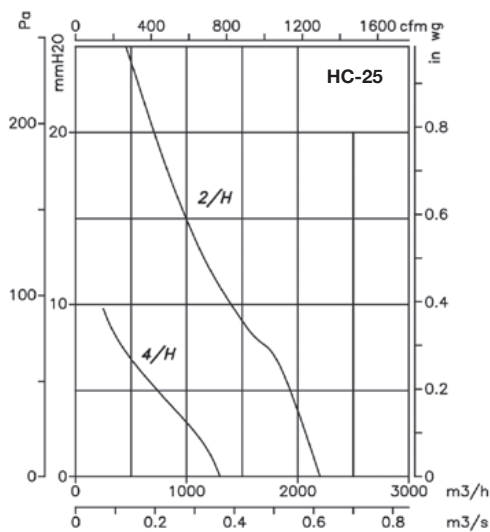

Characteristic curves

Q= Flow rate in m³/h, m³/s and cfm.

Pe= Static pressure in mm H₂O, Pa and inwg.

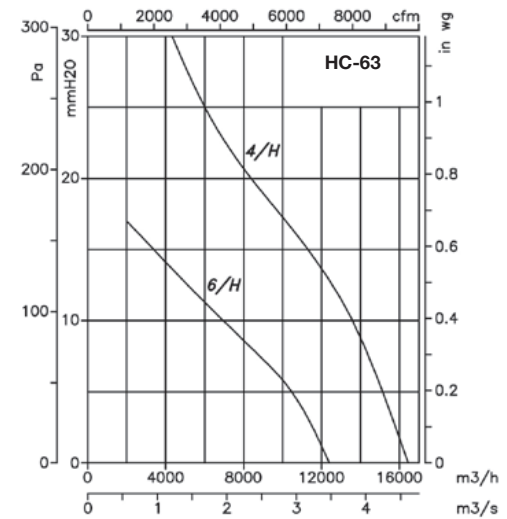
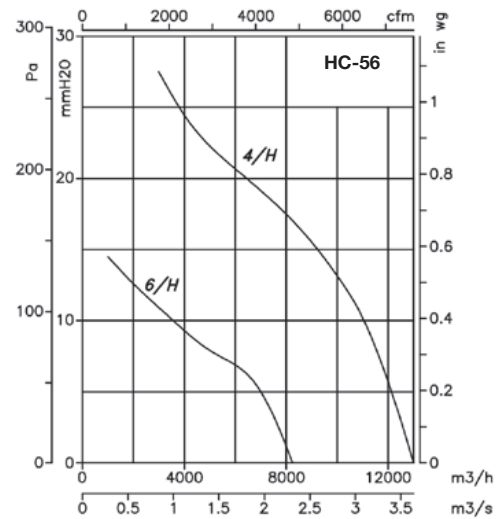
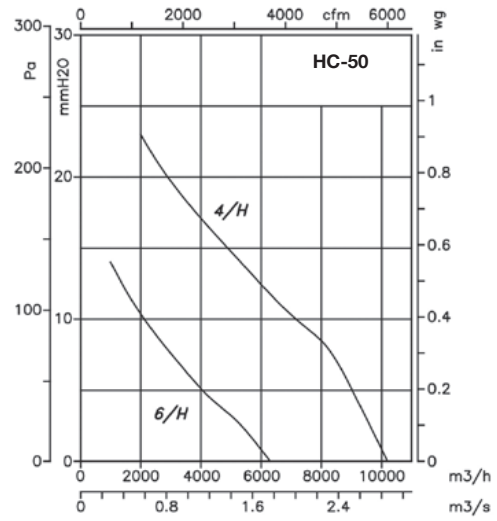
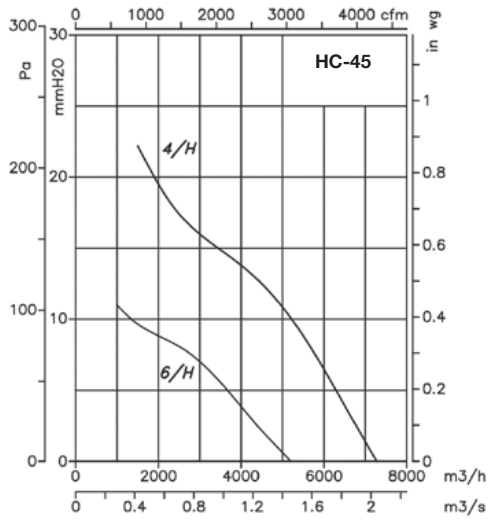
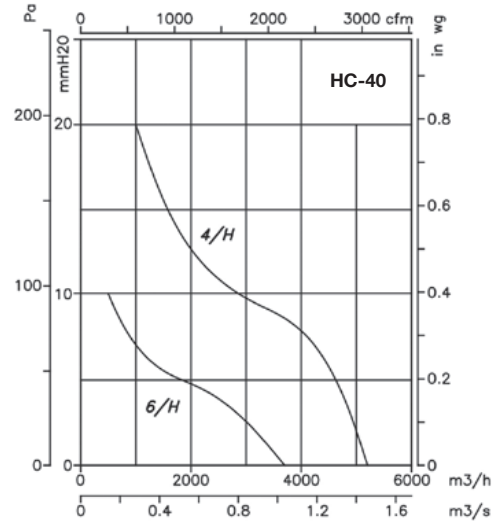
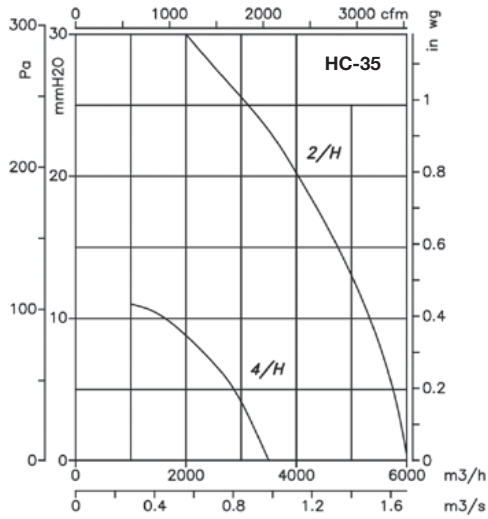

Characteristic curves

Q= Flow rate in m³/h, m³/s and cfm.

Pe= Static pressure in mm H₂O, Pa and inwg.

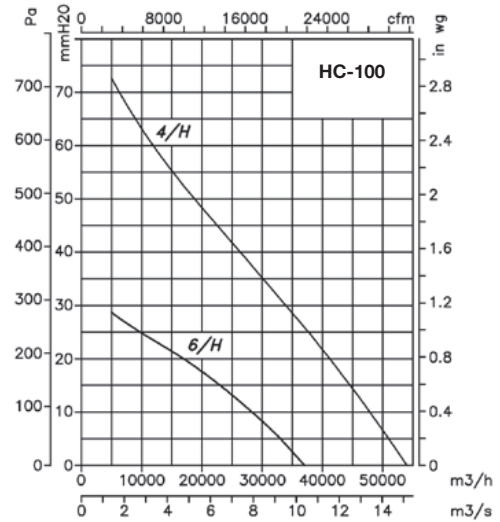
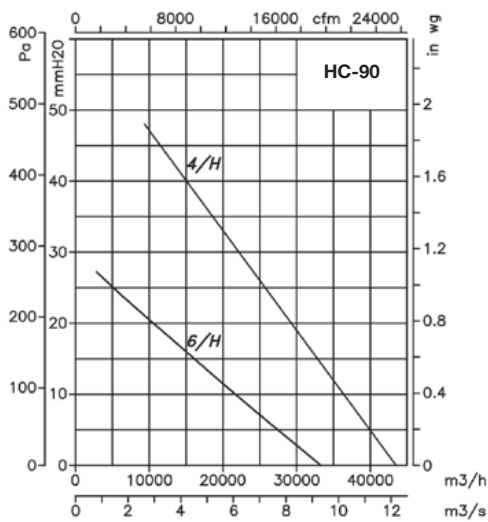
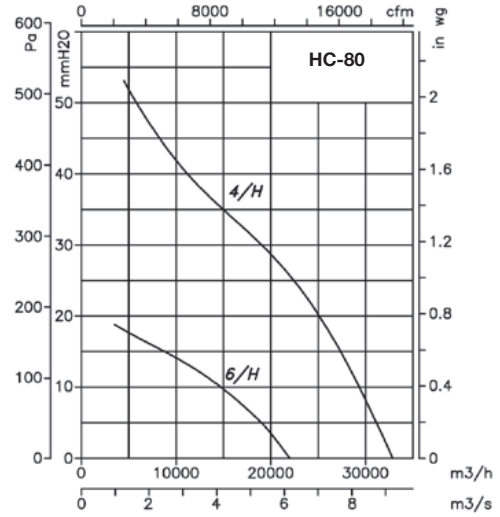
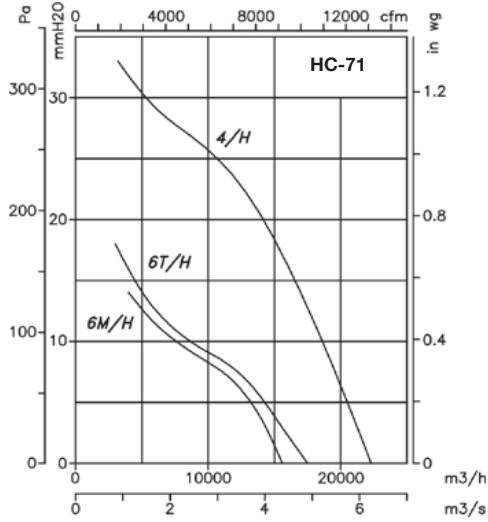

Accessories

See accessories section.



HCD

Wall-mounted axial fans with small diameters



Wall-mounted axial fans with an aluminium sheet impeller, split capacitor motors and built-in connection cable.

Fan:

- Sheet steel support frame.
- Aluminium sheet impeller.
- Anti-contact protective grille pursuant to standard UNE-EN ISO 12499.
- Airflow direction from motor to impeller.

Motor:

- Class B motors with self-lubricating friction bearings, IP44 protection, except model

40, fitted with an F class motor with ball bearings and IP54 protection.

- Single-phase 230V-50Hz.
- Operating temperature: -30°C+ 50°C.

Finish:

- Anti-corrosive finish of polyester resin polymerised at 190 °C, previously degreased with phosphate-free nanotechnological treatment.

On request:

- Special windings for different voltages.

Order code

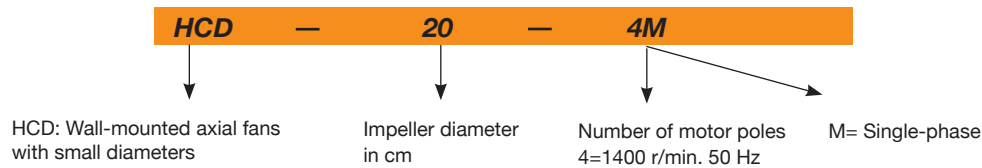

Technical characteristics

Model	Speed (r/min)	Max. admissible current 230V (A)	Absorb. power free discharge (W)	Maximum flow rate (m ³ /h)	Sound pressure level dB(A)	Approx. weight (kg)	According to ErP
HCD-20-4M	1350	0.21	36	560	38	1.15	Excluded
HCD-25-4M	1340	0.25	41	960	43	1.60	Excluded
HCD-30-4M	1360	0.51	76	1350	48	2.15	Excluded
HCD-35-4M	1365	0.80	115	1820	53	6.20	Excluded
HCD-40-4M	1410	1.00	150	3100	57	7.20	2015



Erp. (Energy Related Products)

Information on Directive 2009/125/EC can be downloaded from the SODECA website or the QuickFan selector programme.

Dimensions mm

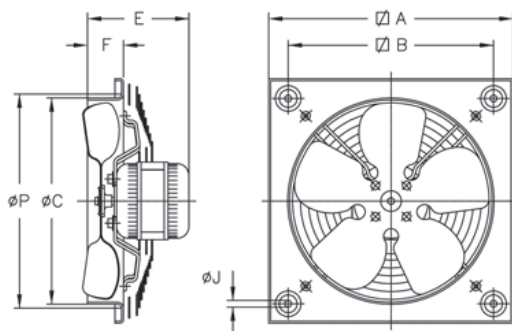

Model	∅A	∅B	∅C	E	F	∅J	∅P
HCD-20	266	222	211	104.5	34	9	240
HCD-25	330	275	262	105.5	56	10.5	290
HCD-30	400	336	311	153	75	10.5	348
HCD-35	465	390	363	166	86	10.5	410
HCD-40	532	452	413	276	97.5	10.5	460

Characteristic curves

Q= Flow rate in m³/h, m³/s and cfm.

Pe= Static pressure in mm H₂O, Pa and inwg.

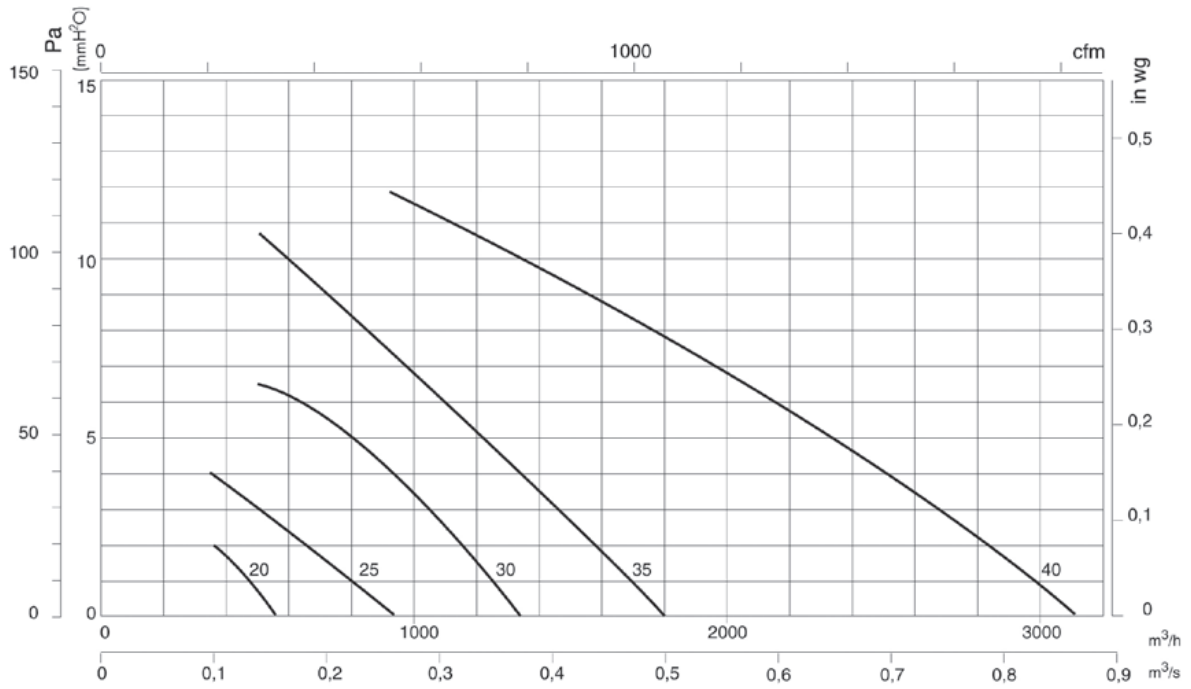

Accessories

See accessories section.

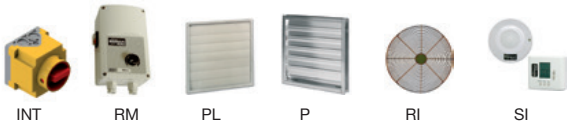

HRE HCRE



HRE: Circular axial fans with external rotor motors

HCRE: Wall-mounted axial fans



HRE



HCRE

Wall-mounted axial fans with support and sheet steel impeller, specially designed to obtain high energy efficiency.

Fan:

- HRE: Sheet steel metal support ring.
- HCRE: Sheet steel support frame.
- Anti-contact protective grille pursuant to standard UNE-EN ISO 12499.
- Sheet steel impeller.
- Grille-impeller airflow direction.

Motor:

- Class F and B motors with ball bearings and IP54 protection.
- High efficiency external rotor motors.
- Single-phase 230V-50Hz and three-phase 400V-50Hz.
- Operating temperature: -30°C +60°C.

Finish:

- Anti-corrosive finish of polyester resin polymerised at 190 °C, previously degreased with phosphate-free nanotechnological treatment.

Order code

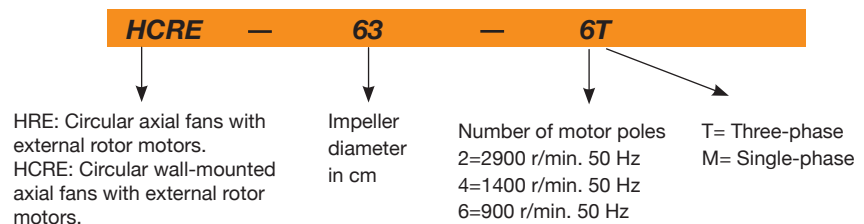

Technical characteristics

Model	Speed (r/min)	Max. admissible current (A)		Max. electric power (kW)	Maximum flow rate (m ³ /h)	Sound pressure level dB(A)	Approx. weight (kg)
		230 V	400 V				
HRE-25-2T	2430		0.18	0.090	1330	56	3.0
HRE-25-2M	2480	0.45		0.100	1330	56	3.0
HRE-25-4T	1400		0.18	0.060	750	53	3.0
HRE-25-4M	1400	0.25		0.050	750	53	3.0
HRE-31-2T	2500		0.25	0.115	1850	59	3.3
HRE-31-2M	2400	0.55		0.125	1850	58	3.3
HRE-31-4T	1380		0.25	0.090	1400	54	3.3
HRE-31-4M	1350	0.42		0.090	1400	54	3.3
HRE-35-4T	1360		0.30	0.140	2670	58	5.0
HRE-35-4M	1380	0.60		0.140	2670	58	5.0

Model	Speed (r/min)	Max. admissible current (A)		Max. electric power (kW)	Maximum flow rate (m ³ /h)	Sound pressure level dB(A)	Approx. weight (kg)
		230 V	400 V				
HCRE-40-4T	1370	-	0.50	0.190	3800	60	6.0
HCRE-40-4M	1350	0.90	-	0.190	3800	60	6.0
HCRE-45-4T	1380	-	0.65	0.290	4500	62	7.5
HCRE-45-4M	1350	1.10	-	0.300	4500	62	7.5
HCRE-45-6T	910	-	0.18	0.165	2800	56	7.5
HCRE-50-4T	1350	-	0.85	0.420	6250	69	10
HCRE-50-4M	1320	2.00	-	0.420	6250	69	10
HCRE-50-6T	920	-	0.62	0.220	4320	66	10
HCRE-50-6M	920	1.10	-	0.220	4320	66	10
HCRE-56-4T	1330	-	1.10	0.550	7500	73	10.5
HCRE-56-4M	1300	2.50	-	0.530	7500	73	10.5
HCRE-56-6T	910	-	0.85	0.320	6500	62	10.5

Technical characteristics

Model	Speed (r/min)	Max. admissible current (A)		Max. electric power (kW)	Maximum flow rate (m ³ /h)	Sound pressure level dB(A)	Approx. weight (kg)
		230 V	400 V				
HCRE-56-6M	910	1.50	-	0.320	6500	62	10.5
HCRE-63-4T	1350	-	1.60	0.850	10800	74	15.4
HCRE-63-4M	1360	3.70	-	0.800	10800	74	15.4
HCRE-63-6T	900	-	1.40	0.550	9300	67	15.4
HCRE-63-6M	900	2.50	-	0.520	9300	67	15.4
HCRE-71-6T	910	-	2.00	1.100	15500	71	25



Erp. (Energy Related Products)

Information on Directive 2009/125/EC can be downloaded from the SODECA website or the QuickFan selector programme.

Dimensions mm

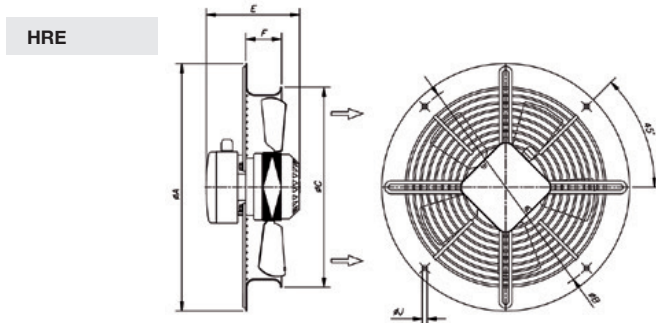

Model	ØA	ØB	ØC	E	F	ØJ
HRE-25-2T	346	320	280	135	50	7
HRE-25-2M	346	320	280	135	50	7
HRE-25-4T	346	320	280	135	50	7
HRE-25-4M	346	320	280	135	50	7
HRE-31-2T	395	360	338	146	63	10
HRE-31-2M	395	360	338	146	63	10
HRE-31-4T	395	360	338	146	63	10
HRE-31-4M	395	360	338	146	63	10
HRE-35-4T	460	420	383	175	65	10
HRE-35-4M	460	420	383	175	65	10

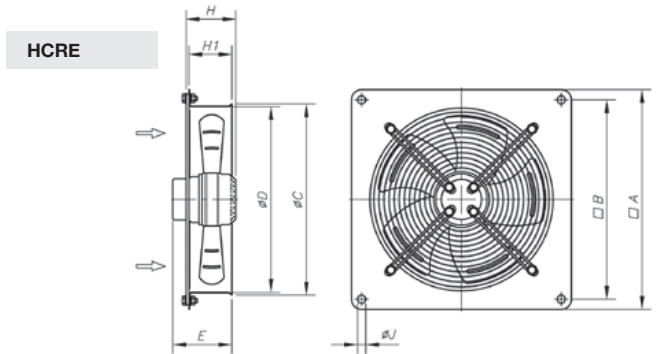

Model	A	B	øC	øD	E	H	H1	øJ
HCRE-40	540	490	430	410	172	-	83	10
HCRE-45	575	520	480	460	185	-	90	10
HCRE-50	665	615	530	510	189	-	106	10
HCRE-56	725	670	570	560	203	-	106	10
HCRE-63	805	750	665	645	225	-	110	10
HCRE-71	850	810	755	725	-	235	-	10

Characteristic curves

Q= Flow rate in m³/h, m³/s and cfm.

Pe= Static pressure in mm H₂O, Pa and inwg.

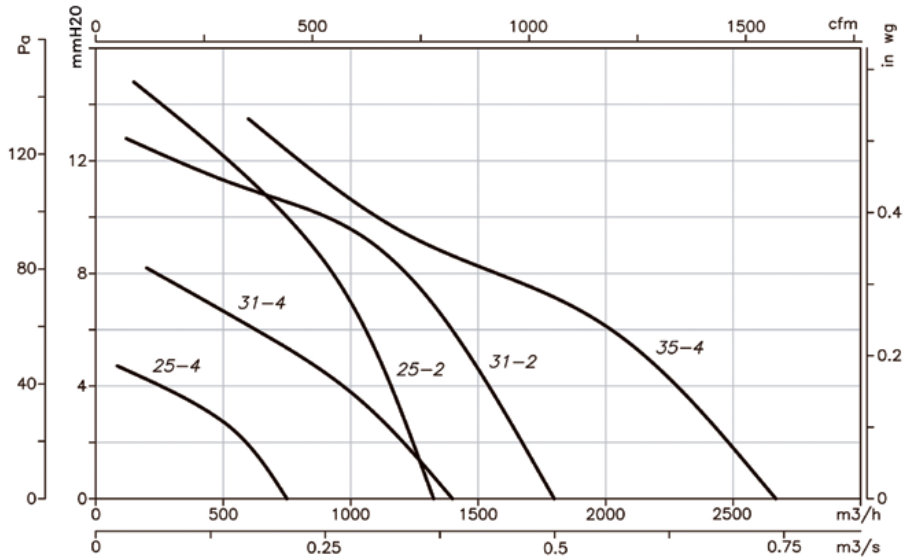

Characteristic curves

Q= Flow rate in m³/h, m³/s and cfm.

Pe= Static pressure in mm H₂O, Pa and inwg.

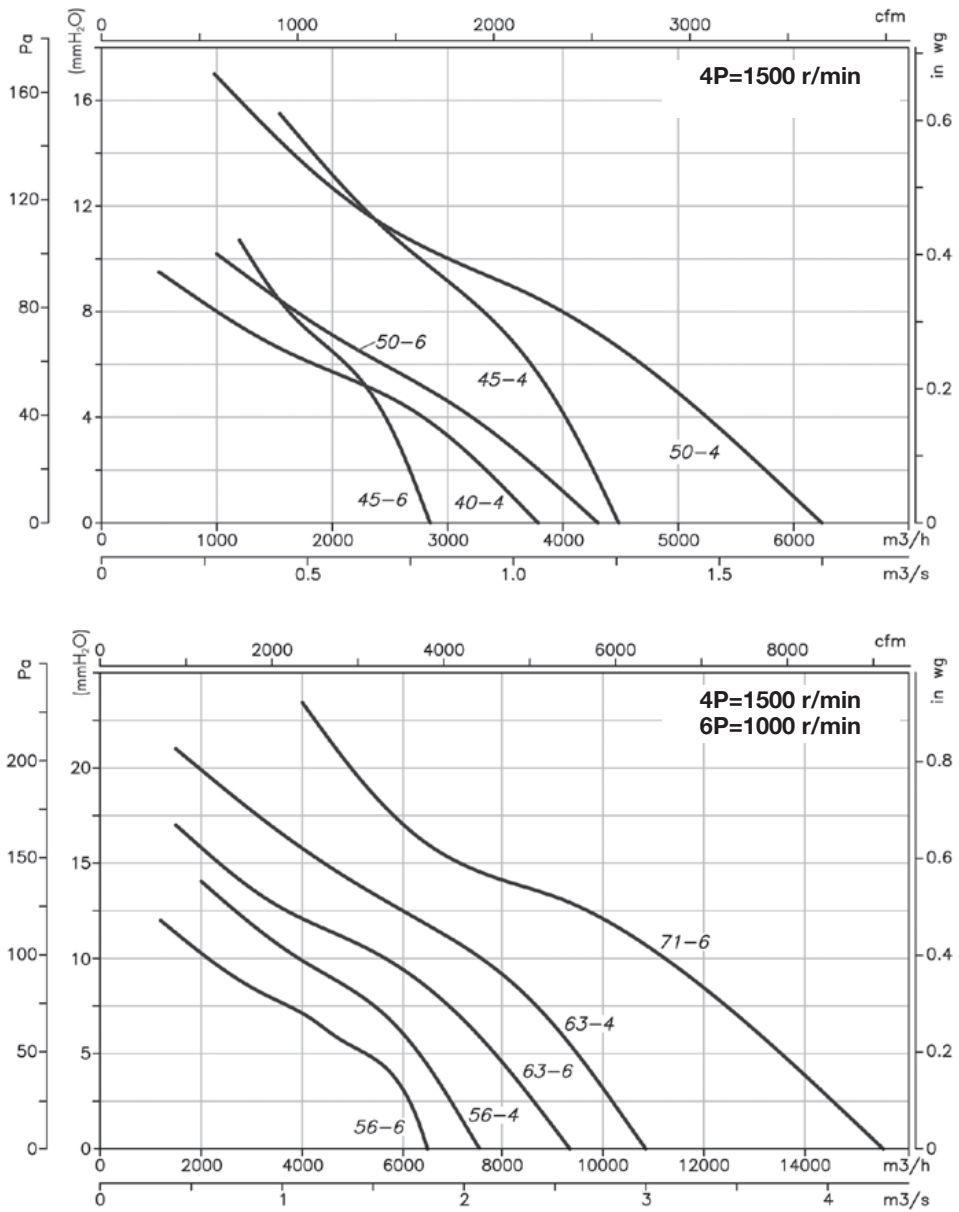

Accessories

See accessories section.





HCH HCT

Extremely robust wall-mounted or tubular axial fans



HCH



HCT

Axial or tubular wall-mounted fans, PL version fitted with a plastic impeller and AL version with an aluminium impeller.

Fan:

- Airflow direction from motor to impeller.
- PL version in fibreglass-reinforced polyamide-6 rots and AL version in cast aluminium. Models 40-2T and HCT-45-2T only in AL version.
- HCH: Sheet steel metal support ring.
- HCT: Tubular casing in sheet steel with external terminal box.

Motor:

- IE3 efficiency motors for powers equal to or higher than 0.75kW except single-phase, 2-speed and 8-pole.
- Class F motors with ball bearings, IP55 protection, except single-phase models from size 45 to size 56, IP54 protection. 1 or 2 speeds, depending on model.

- Single-phase 230V-50Hz and three-phase 230/400V-50Hz (up to 4kW) and 400/690V-50Hz (powers higher than 4kW).
- Operating temperature: -25°C+ 50°C.

Finish:

- Anti-corrosive finish of polyester resin polymerised at 190°C, previously degreased with phosphate-free nanotechnological treatment.

On request:

- Airflow direction from impeller to motor.
- 100% reversible impellers.
- Special windings for different voltages.
- ATEX-certified Category 2.



Order code

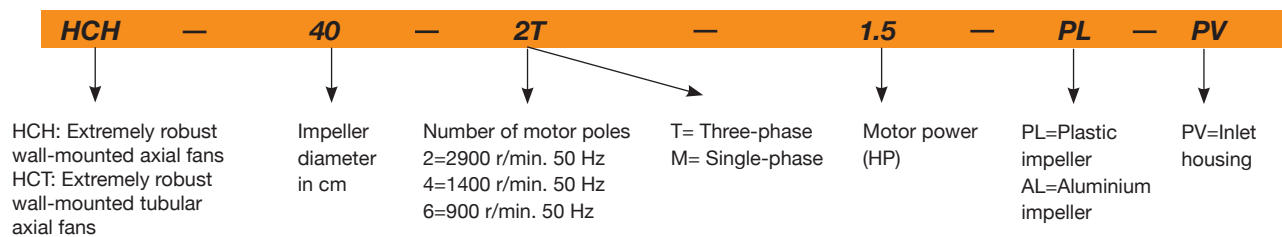

Technical characteristics

Model	Speed (r/min)	Max. admissible current (A)			Installed power (kW)	Maximum flow rate (m³/h)	Sound pressure level dB(A)	Approx. weight (kg)		According to ErP	
		230 V	400 V	690 V				HCH	HCT	HCH	HCT
- HCT 25-2T	2670	0.64	0.37		0.09	1950	64	-	7	-	2015
- HCT 25-2M	2760	0.79			0.09	1950	64	-	7	-	*
- HCT 25-4T	1320	0.65	0.38		0.09	1000	50	-	7	-	Excluded
- HCT 25-4M	1380	0.65			0.10	1000	50	-	7	-	Excluded
- HCT 31-2T	2750	1.21	0.7		0.18	2900	70	-	8	-	2015
- HCT 31-2M	2780	1.42			0.18	2900	70	-	8	-	*
- HCT 31-4T	1320	0.65	0.38		0.09	1550	52	-	8	-	Excluded
- HCT 31-4M	1380	0.65			0.10	1550	52	-	8	-	Excluded
HCH HCT 35-2T	2710	1.92	1.11		0.37	5750	77	9	12	2015	2015
- HCT 35-2M	2780	2.53			0.37	5750	77	-	12	-	2015
HCH HCT 35-4T	1320	0.65	0.38		0.09	3100	59	7	10	2015	2015
- HCT 35-4M	1380	0.65			0.10	3100	59	-	10	-	2015
HCH HCT 40-2T-1.5 IE3	2830	4.03	2.34		1.10	8800	84	18	26	2015	2015
HCH HCT 40-4T-0.33	1350	1.66	0.96		0.25	5150	64	13	21	2015	2015
- HCT 45-2T-2 IE3	2875	5.34	3.07		1.50	10650	86	-	35	-	2015
- HCT 45-2T-3 IE3	2910	7.32	4.21		2.20	12750	88	-	39	-	2015

Technical characteristics

Model	Speed (r/min)	Max. admissible current (A)			Installed power (kW)	Maximum flow rate (m ³ /h)	Sound pressure level dB(A)	Approx. weight (kg)		According to ErP	
		230 V	400 V	690 V				HCH	HCT	HCH	HCT
HCH HCT 45-4T-0.5	1370	2.02	1.17		0.37	7100	68	15	24	2015	2015
HCH HCT 45-4M-0.5	1400	2.76			0.37	7100	68	15	24	2015	2015
HCH - 45-6T-0.33	900	1.51	0.87		0.25	4750	55	14	-	2015	-
- HCT 50-4T-0.75	1380	2.92	1.69		0.55	10400	70	-	28	-	2015
HCH HCT 56-4T-0.75	1380	2.92	1.69		0.55	11050	72	21	33	2015	2015
HCH HCT 56-4T-1 IE3	1420	2.82	1.62		0.75	12950	73	23	35	2015	2015
HCH HCT 56-4T-1.5 IE3	1455	4.07	2.34		1.10	14000	74	30	41	2015	2015
HCH HCT 56-4T-2 IE3	1440	5.41	3.11		1.50	15300	75	36	47	2015	2015
HCH HCT 56-6T-0.33	900	1.51	0.87		0.25	8500	61	18	30	2015	2015
HCH HCT 56-6T-0.5	900	2.24	1.30		0.37	9300	61	20	32	2015	2015
HCH HCT 56-6T-0.75	900	2.99	1.73		0.55	10000	62	22	34	2015	2015
HCH HCT 63-4T-1 IE3	1420	2.82	1.62		0.75	14150	73	28	43	2015	2015
HCH HCT 63-4T-1.5 IE3	1455	4.07	2.34		1.10	17000	74	34	49	2015	2015
HCH HCT 63-4T-2 IE3	1440	5.41	3.11		1.50	18900	75	41	56	2015	2015
HCH HCT 63-4T-3 IE3	1435	7.93	4.56		2.20	22100	76	42	58	2015	2015
HCH HCT 63-4T-4 IE3	1440	10.70	6.15		3.00	25400	77	48	64	2015	2015
HCH HCT 63-6T-0.5	900	2.24	1.30		0.37	12150	64	25	40	2015	2015
HCH HCT 63-6T-0.75	900	2.99	1.73		0.55	12750	65	27	42	2015	2015
HCH HCT 63-6T-1 IE3	940	3.36	1.93		0.75	13800	66	36	51	*	*
HCH HCT 71-4T-1.5 IE3	1455	4.07	2.34		1.10	19750	78	37	56	2015	2015
HCH HCT 71-4T-2 IE3	1440	5.41	3.11		1.50	21100	79	44	63	2015	2015
HCH HCT 71-4T-3 IE3	1435	7.93	4.56		2.20	23950	81	46	65	2015	2015
HCH HCT 71-4T-4 IE3	1440	10.70	6.15		3.00	29400	82	52	71	2015	2015
HCH HCT 71-6T-0.75	900	2.99	1.73		0.55	15150	67	29	49	2015	2015
HCH HCT 71-6T-1 IE3	940	3.36	1.93		0.75	17250	68	39	58	2015	2015
HCH HCT 71-6T-1.5 IE3	945	4.68	2.69		1.10	20950	69	44	63	2015	2015
HCH HCT 80-4T-3 IE3	1435	7.93	4.56		2.20	28000	82	54	73	2015	2015
HCH HCT 80-4T-4 IE3	1440	10.70	6.15		3.00	32700	83	60	79	2015	2015
HCH HCT 80-4T-5.5 IE3	1450	13.90	8.00		4.00	37200	84	62	81	2015	2015
HCH HCT 80-6T-1 IE3	940	3.36	1.93		0.75	20600	71	47	67	2015	2015
HCH HCT 80-6T-1.5 IE3	945	4.68	2.69		1.10	24250	72	52	72	2015	2015
HCH HCT 80-6T-2 IE3	950	6.43	3.70		1.50	28000	73	56	75	2015	2015
HCH HCT 80-6T-3 IE3	950	9.08	5.22		2.20	32500	74	61	80	2015	2015
HCH HCT 90-4T-4 IE3	1440	10.70	6.15		3.00	37750	87	67	95	2015	2015
HCH HCT 90-4T-5.5 IE3	1450	13.90	8.00		4.00	41850	89	69	97	2015	2015
HCH HCT 90-4T-7.5 IE3	1465		10.30	5.97	5.50	47000	91	106	132	2015	2015
HCH HCT 90-4T-10 IE3	1465		13.90	8.06	7.50	53000	92	110	136	2015	2015
HCH HCT 90-6T-3 IE3	950	9.08	5.22		2.20	35000	78	68	96	2015	2015
HCH HCT 90-6T-4 IE3	970	12.00	6.91		3.00	40000	79	88	114	2015	2015
HCH HCT 100-4T-7.5 IE3	1465		10.30	5.97	5.50	52500	92	114	144	2015	2015
HCH HCT 100-4T-10 IE3	1465		13.90	8.06	7.50	58500	93	118	147	2015	2015
HCH HCT 100-4T-15 IE3	1470		20.90	12.10	11.00	68000	94	150	185	2015	2015
HCH HCT 100-4T-20 IE3	1465		27.90	16.20	15.00	71850	95	161	196	2015	2015
HCH HCT 100-6T-3 IE3	950	9.08	5.22		2.20	40500	82	76	107	2015	2015
HCH HCT 100-6T-4 IE3	970	12.00	6.91		3.00	46950	83	96	125	2015	2015
HCH HCT 100-6T-5.5 IE3	960	15.60	8.99		4.00	52000	84	102	131	2015	2015

* Equipment not covered by Directive 2009/125/EC



Erp. (Energy Related Products)

Information on Directive 2009/125/EC can be downloaded from the SODECA website or the QuickFan selector programme.

Accessories

See accessories section.

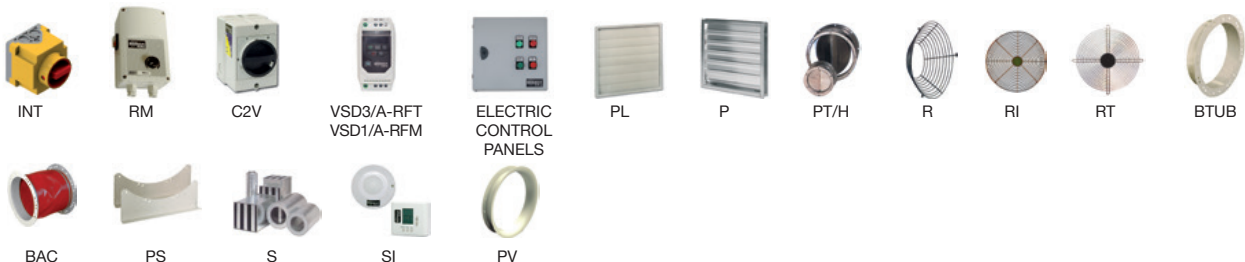

AXIAL FANS AND ROOF-MOUNTED EXTRACT FANS

Acoustic characteristics

The indicated values are determined by measuring the pressure and sound power levels in dB(A) obtained in a free field at a distance equivalent to twice the size of the fan plus the impeller diameter, with a minimum of 1.5 m.

Noise power spectrum Lw(A) in dB(A) frequency band in [Hz]

Model	63	125	250	500	1000	2000	4000	8000	Model	63	125	250	500	1000	2000	4000	8000
25-2	35	50	69	68	69	68	63	54	71-4-1.5	55	75	83	88	90	87	80	69
25-4	21	36	55	54	55	54	49	40	71-4-2	56	76	84	89	91	88	81	70
31-2	41	56	75	74	75	74	69	60	71-4-3	58	78	86	91	93	90	83	72
31-4	23	38	57	56	57	56	51	42	71-4-4	59	79	87	92	94	91	84	73
35-2	48	63	82	81	82	81	76	67	71-6-0.75	44	64	72	77	79	76	69	58
35-4	30	45	64	63	64	63	58	49	71-6-1	45	65	73	78	80	77	70	59
40-2	55	70	89	88	89	88	83	74	71-6-1.5	46	66	74	79	81	78	71	60
40-4	35	50	69	68	69	68	63	54	80-4-3	59	79	87	92	94	91	84	73
45-2-2	51	68	80	88	93	93	89	82	80-4-4	60	80	88	93	95	92	85	74
45-2-3	53	70	82	90	95	95	91	84	80-4-5.5	61	81	89	94	96	93	86	75
45-4-0.5	33	50	62	70	75	75	71	64	80-6-1	48	68	76	81	83	80	73	62
45-6	20	37	49	57	62	62	58	51	80-6-1.5	49	69	77	82	84	81	74	63
50-4	37	54	67	74	79	80	75	68	80-6-2	50	70	78	83	85	82	75	64
56-4-0.75	47	67	75	80	82	79	72	61	80-6-3	51	71	79	84	86	83	76	65
56-4-1	48	68	76	81	83	80	73	62	90-4-4	65	86	93	98	101	97	90	79
56-4-1.5	49	69	77	82	84	81	74	63	90-4-5.5	67	88	95	100	103	99	92	81
56-4-2	50	70	78	83	85	82	75	64	90-4-7.5	69	90	97	102	105	101	94	83
56-6-0.33	36	56	64	69	71	68	61	50	90-4-10	70	91	98	103	106	102	95	84
56-6-0.5	36	56	64	69	71	68	61	50	90-6-3	56	77	84	89	92	88	81	70
56-6-0.75	37	57	65	70	72	69	62	51	90-6-4	57	78	85	90	93	89	82	71
63-4-1	50	70	78	83	85	82	75	64	100-4-7.5	72	92	100	105	107	104	97	86
63-4-1.5	51	71	79	84	86	83	76	65	100-4-10	73	93	101	106	108	105	98	87
63-4-2	52	72	80	85	87	84	77	66	100-4-15	74	94	102	107	109	106	99	88
63-4-3	53	73	81	86	88	85	78	67	100-4-20	75	95	103	108	110	107	100	89
63-4-4	54	74	82	87	89	86	79	68	100-6-3	62	82	90	95	97	94	87	76
63-6-0.5	41	61	69	74	76	73	66	55	100-6-4	63	83	91	96	98	95	88	77
63-6-0.75	42	62	70	75	77	74	67	56	100-6-5.5	64	84	92	97	99	96	89	78
63-6-1	43	63	71	76	78	75	68	57									

Dimensions mm

HCH

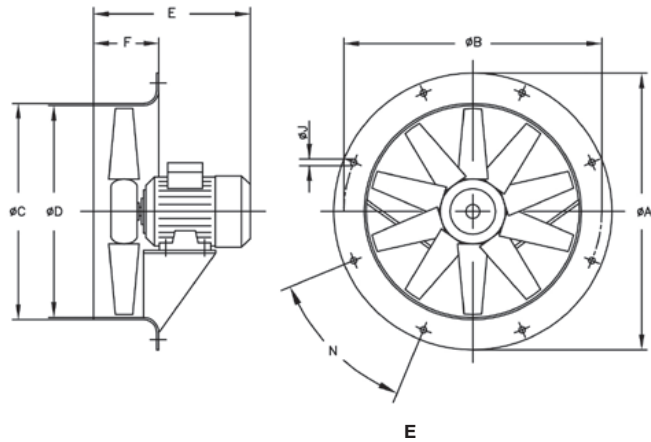

Model	ØA	ØB	ØC	ØD	0.16	0.33	0.5	0.75	1	1.5	2	3	4	5.5	7.5	10	15	20	F	ØJ	N
HCH-35-2	425	395	358	355	-	-	285	-	-	-	-	-	-	-	-	-	-	-	110	10	8x45°
HCH-35-4	425	395	358	355	257	-	-	-	-	-	-	-	-	-	-	-	-	-	110	10	8x45°
HCH-40-2	490	450	414	410	-	-	-	-	-	314	-	-	-	-	-	-	-	-	120	12	8x45°
HCH-40-4	490	450	414	410	-	305	-	-	-	-	-	-	-	-	-	-	-	-	120	12	8x45°
HCH-45-4	540	500	464	460	-	-	295	-	-	-	-	-	-	-	-	-	-	-	120	12	8x45°
HCH-45-6	540	500	464	460	-	295	-	-	-	-	-	-	-	-	-	-	-	-	120	12	8x45°
HCH-56-4	660	620	564	560	-	-	-	316	316	330	354	-	-	-	-	-	-	-	120	12	12x30°
HCH-56-6	660	620	564	560	-	298	316	316	-	-	-	-	-	-	-	-	-	-	120	12	12x30°
HCH-63-4	730	690	645	640	-	-	-	-	332	340	366	420	420	-	-	-	-	-	150	12	12x30°
HCH-63-6	730	690	645	640	-	-	332	332	340	-	-	-	-	-	-	-	-	-	150	12	12x30°
HCH-71-4	810	770	715	710	-	-	-	-	-	334	360	430	430	-	-	-	-	-	150	12	16x22°30'
HCH-71-6	810	770	715	710	-	-	-	323	334	360	-	-	-	-	-	-	-	-	150	12	16x22°30'
HCH-80-4	900	860	805	800	-	-	-	-	-	-	425	425	445	-	-	-	-	-	180	12	16x22°30'
HCH-80-6	900	860	805	800	-	-	-	-	360	386	425	445	-	-	-	-	-	-	180	12	16x22°30'
HCH-90-4	1015	970	906	900	-	-	-	-	-	-	-	436	430	465	465	-	-	-	180	12	16x22°30'
HCH-90-6	1015	970	906	900	-	-	-	-	-	-	436	430	465	-	-	-	-	-	180	12	16x22°30'
HCH-100-4	1115	1070	1006	1000	-	-	-	-	-	-	-	-	-	-	503	503	612	612	200	15	16x22°30'
HCH-100-6	1115	1070	1006	1000	-	-	-	-	-	-	-	440	503	503	-	-	-	-	200	15	16x22°30'

Dimensions mm

HCT

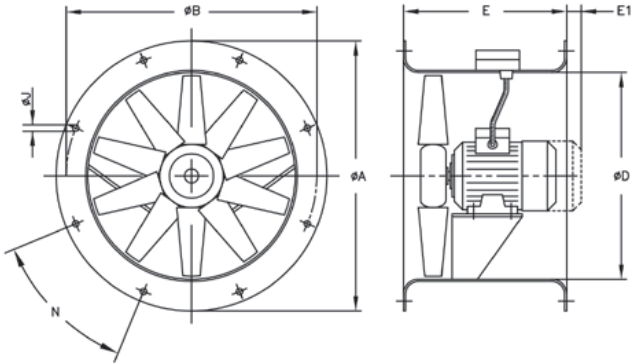

Model	ØA	ØB	ØD	E	E1	ØJ	N
HCT-25	310	280	240	230	10	10	4x90°
HCT-31	350	320	280	270	-	10	4x90°
HCT-35	425	395	355	280	-	10	8x45°
HCT-40	490	450	410	320	-	12	8x45°
HCT-45	540	500	460	360	-	12	8x45°
HCT-50	600	560	514	360	-	12	12x30°
HCT-56	660	620	560	400	-	12	12x30°
HCT-63	730	690	640	430	-	12	12x30°
HCT-71	810	770	710	500	-	12	16x22°30'
HCT-80	900	860	800	500	-	12	16x22°30'
HCT-90	1015	970	900	500	-	15	16x22°30'
HCT-100	1115	1070	1000	600	-	15	16x22°30'
HCT-100-4T-15	1115	1070	1000	700	-	15	16x22°30'
HCT-100-4T-20	1115	1070	1000	700	-	15	16x22°30'

Characteristic curves

Q= Flow rate in m³/h, m³/s and cfm.

Pe= Static pressure in mm H₂O, Pa and inwg.

2-Pole=3000 r/min

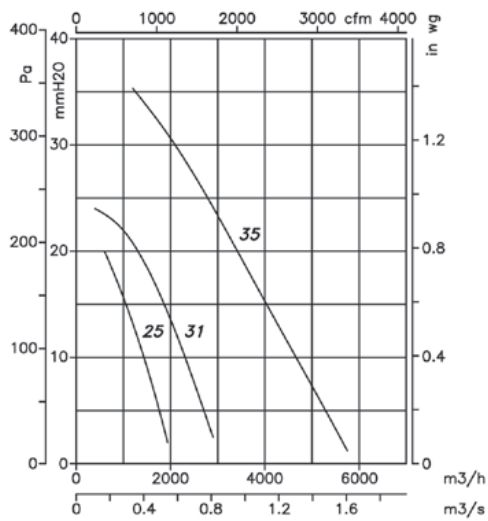

2-Pole=3000 r/min

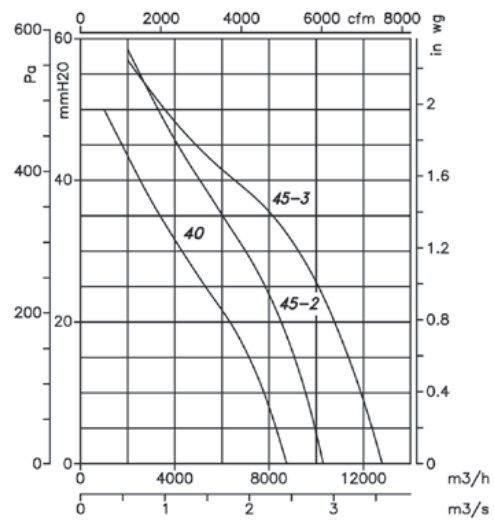

4-Pole=1500 r/min

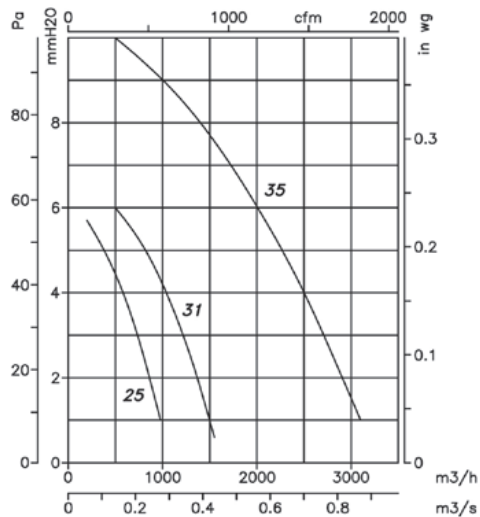

4-Pole=1500 r/min

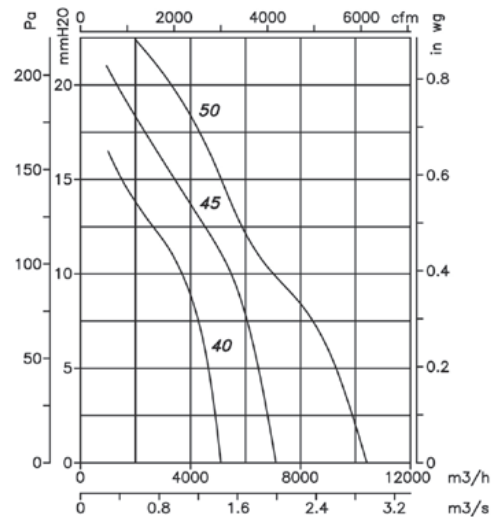

Characteristic curves

Q= Flow rate in m³/h, m³/s and cfm.

Pe= Static pressure in mm H₂O, Pa and inwg.

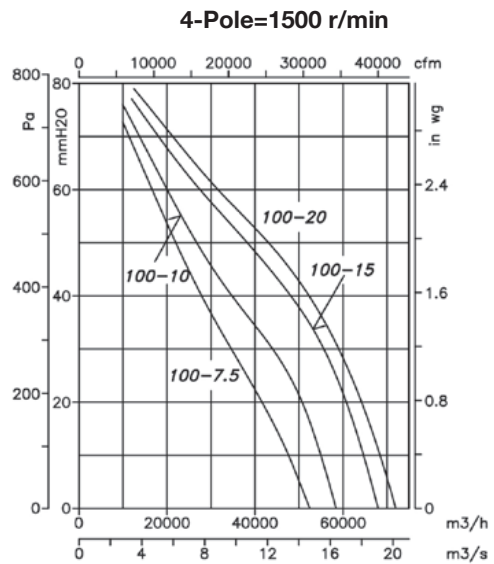
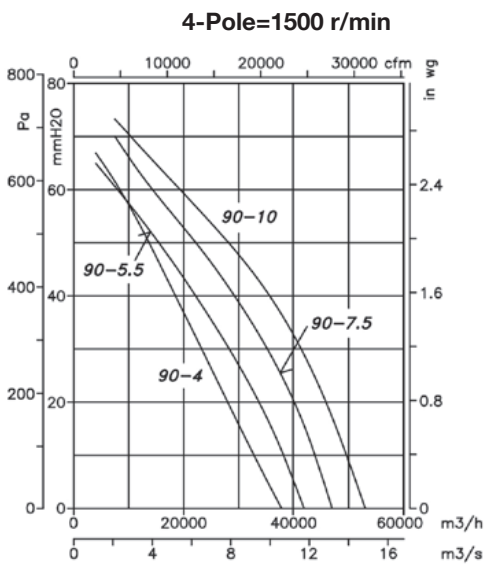
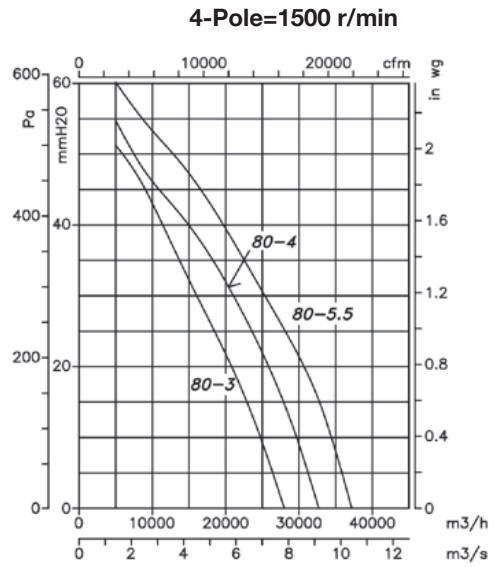
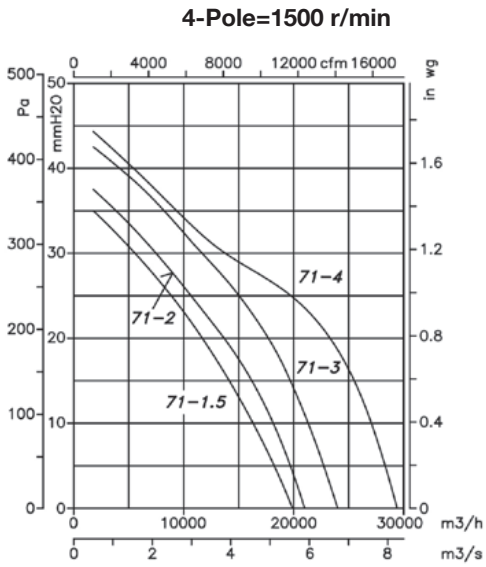
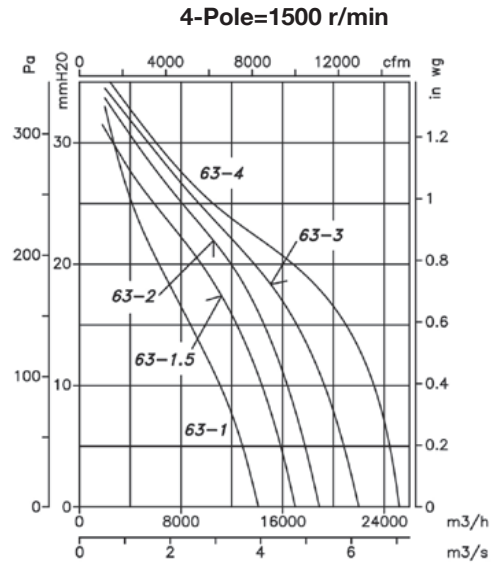
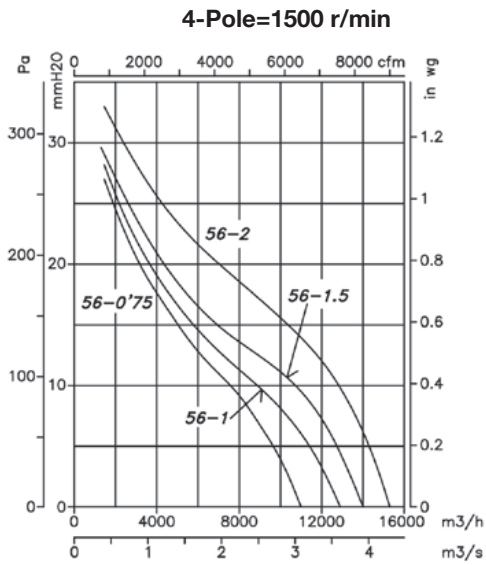

Characteristic curves

Q= Flow rate in m³/h, m³/s and cfm.

Pe= Static pressure in mm H₂O, Pa and inwg.

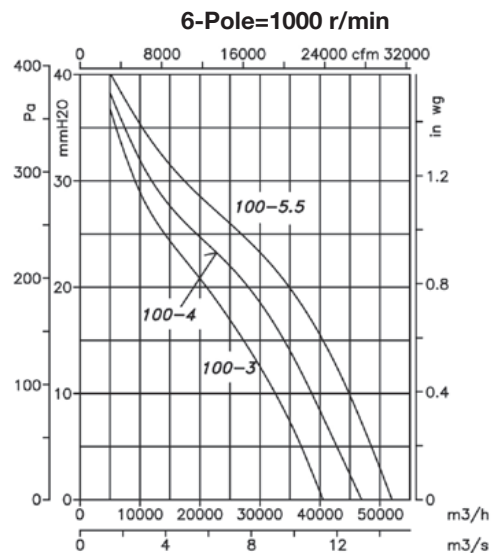
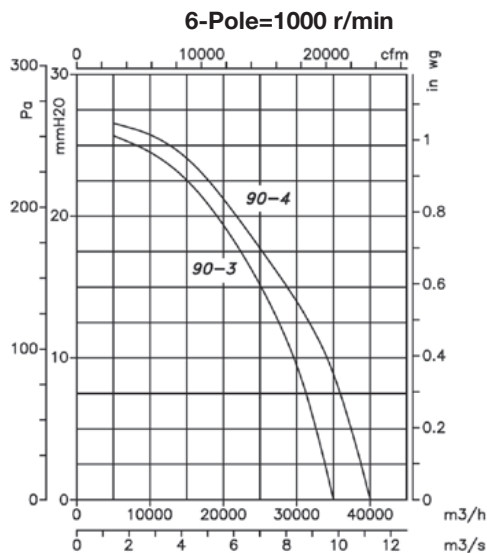
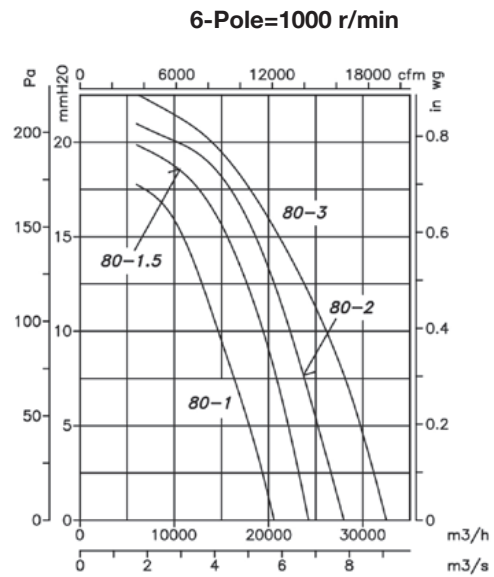
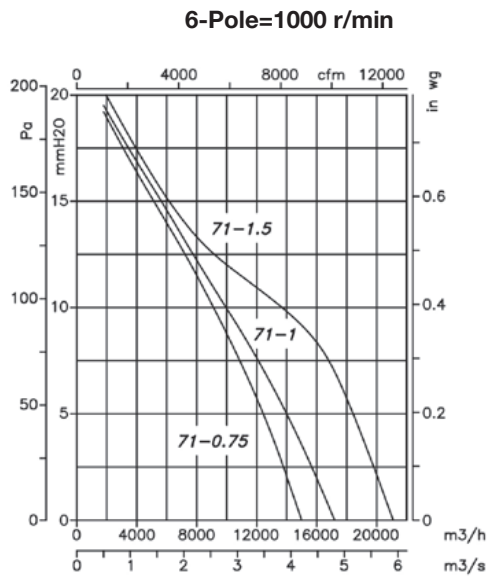
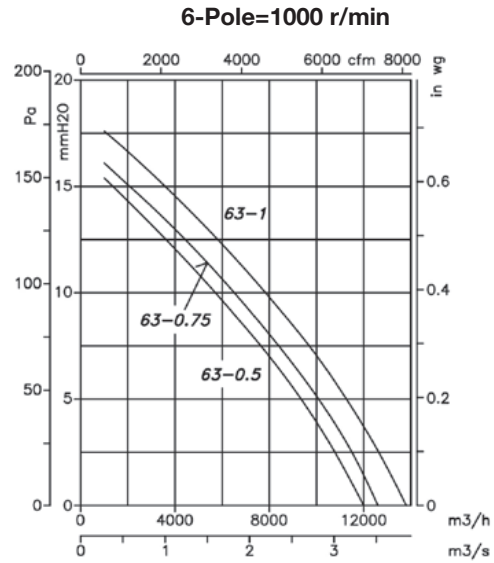
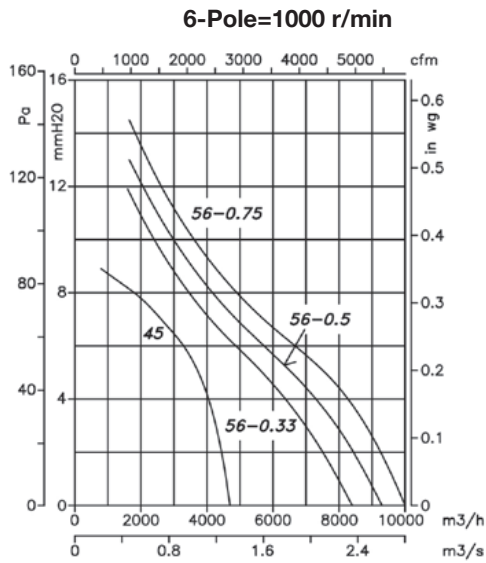

HFW

Hot dip galvanised tubular fans



Tubular axial fans designed with four support arms to reduce vibrations and fitted with an aerodynamic aluminium low-consumption impeller.

Fan:

- Airflow direction from motor to impeller.
- AL version impellers made of cast aluminium.
- Support ring made of sheet steel with double flange and cable gland for motor power supply.
- Hot dip galvanised tubular sheet steel casing.

Motor:

- IE3 efficiency motors for powers equal to or higher than 0.75kW except single-phase, 2-speed and 8-pole.

- Class F motors with ball bearings and IP55 protection.
- Three-phase 230/400V-50Hz (up to 4kW) and 400/690V-50Hz (powers higher than 4kW).
- Operating temperature: -25°C +50°C.

Finish:

- Hot dip galvanising.

On request:

- Airflow direction from impeller to motor.
- Fibreglass-reinforced polyamide PL version impellers
- 100% reversible impellers.
- Special windings for different voltages.
- ATEX-certified Category 2.

Order code

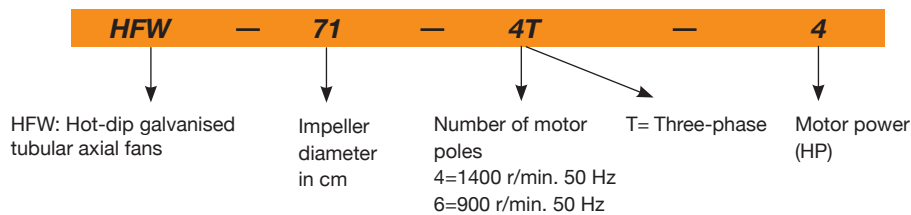

Technical characteristics

Model	Speed (r/min)	Maximum admissible current (A)			Installed power (kW)	Blade inclination angle (°)	Maximum flow rate (m³/h)	Sound pressure level dB(A)	Approx. weight (kg)	According to ErP
		230V	400V	690V						
HFW-56-4T-1 IE3	1420	2.82	1.62	0.75	22	11250	73	29	2015	
HFW-56-4T-1.5 IE3	1455	4.07	2.34	1.10	30	13600	74	36	2015	
HFW-56-4T-2 IE3	1440	5.41	3.11	1.50	36	15050	75	38	2015	
HFW-56-6T-0.75	910	2.59	1.49	0.55	38	10150	62	23	*	
HFW-63-4T-1 IE3	1420	2.82	1.62	0.75	14	15200	73	30	2015	
HFW-63-4T-1.5 IE3	1455	4.07	2.34	1.10	20	17800	74	36	2015	
HFW-63-4T-2 IE3	1440	5.41	3.11	1.50	24	19300	75	43	2015	
HFW-63-4T-3 IE3	1435	7.93	4.56	2.20	32	22150	76	44	2015	
HFW-63-4T-4 IE3	1440	10.70	6.15	3.00	38	24250	77	50	2015	
HFW-63-6T-0.75	910	2.59	1.49	0.55	28	13600	65	29	2015	
HFW-63-6T-1 IE3	940	3.36	1.93	0.75	38	15900	66	38	2015	
HFW-71-4T-1.5 IE3	1455	4.07	2.34	1.10	12	19500	78	39	2015	
HFW-71-4T-2 IE3	1440	5.41	3.11	1.50	14	20900	79	46	2015	
HFW-71-4T-3 IE3	1435	7.93	4.56	2.20	22	25100	81	48	2015	
HFW-71-4T-4 IE3	1440	10.70	6.15	3.00	28	27500	82	54	2015	
HFW-71-6T-0.75	910	2.59	1.49	0.55	20	16100	67	31	2015	
HFW-71-6T-1 IE3	940	3.36	1.93	0.75	26	17300	68	41	2015	
HFW-71-6T-1.5 IE3	945	4.68	2.69	1.10	34	19950	69	46	2015	
HFW-80-4T-3 IE3	1435	7.93	4.56	2.20	12	25450	82	56	2015	
HFW-80-4T-4 IE3	1440	10.70	6.15	3.00	16	30250	83	62	2015	
HFW-80-4T-5.5 IE3	1450	13.90	8.00	4.00	18	32750	84	64	2015	
HFW-80-6T-1.5 IE3	945	4.68	2.69	1.10	18	21450	72	54	2015	
HFW-80-6T-2 IE3	950	6.43	3.70	1.50	26	25950	73	58	2015	
HFW-80-6T-3 IE3	950	9.08	5.22	2.20	32	29950	74	63	2015	
HFW-90-4T-4 IE3	1440	10.70	6.15	3.00	8	33600	87	71	2015	

Technical characteristics

Model	Speed (r/min)	Maximum admissible current (A)			Installed power (kW)	Blade inclination angle (°)	Maximum flow rate (m³/h)	Sound pressure level dB(A)	Approx. weight (kg)	According to ErP
		230V	400V	690V						
HFW-90-4T-5.5 IE3	1450	13.90	8.00		4.00	12	38900	89	73	2015
HFW-90-4T-7.5 IE3	1465		10.30	5.97	5.50	18	46150	91	110	2015
HFW-90-4T-10 IE3	1455		14.20	8.20	7.50	22	50150	92	98	2015
HFW-90-6T-2 IE3	950	6.43	3.70		1.50	16	28800	77	67	2015
HFW-90-6T-3 IE3	950	9.08	5.22		2.20	24	34000	78	72	2015
HFW-90-6T-4 IE3	970	12.00	6.91		3.00	30	38900	79	92	2015
HFW-100-4T-7.5 IE3	1465		10.30	5.97	5.50	10	46850	92	118	2015
HFW-100-4T-10 IE3	1455		14.20	8.20	7.50	16	57400	93	106	2015
HFW-100-4T-15 IE3	1460		20.20	11.60	11.00	22	66300	94	129	2015
HFW-100-4T-20 IE3	1465		29.80	17.30	15.00	28	76150	95	148	2015
HFW-100-6T-3 IE3	950	9.08	5.22		2.20	16	37600	82	80	2015
HFW-100-6T-4 IE3	970	12.00	6.91		3.00	20	41150	83	100	2015
HFW-100-6T-5.5 IE3	960	15.60	8.99		4.00	26	47800	84	106	2015

* Equipment not covered by Directive 2009/125/EC

Acoustic characteristics

The indicated values are determined by measuring the sound pressure level and sound power in dB(A) obtained in a free field at a distance equivalent to twice the size of the fan plus the impeller diameter, with a minimum of 1.5 m.

Sound power spectrum Lw(A) in dB(A) per Hz frequency band

Model	63	125	250	500	1000	2000	4000	8000	Model	63	125	250	500	1000	2000	4000	8000
HFW-56-4T-1	48	68	76	81	83	80	73	62	HFW-80-4T-4	56	76	84	89	91	88	81	74
HFW-56-4T-1.5	49	69	77	82	84	81	74	63	HFW-80-4T-5.5	56	76	84	89	91	88	81	70
HFW-56-4T-2	50	70	78	83	85	82	75	64	HFW-80-6T-1.5	49	66	74	79	81	78	71	60
HFW-56-6T-0.75	37	57	65	70	72	69	62	51	HFW-80-6T-2	50	67	75	80	82	79	72	61
HFW-63-4T-1	50	70	78	83	85	82	75	64	HFW-80-6T-3	51	68	76	81	83	80	73	62
HFW-63-4T-1.5	48	68	76	81	83	80	73	65	HFW-90-4T-4	61	82	89	94	97	93	86	79
HFW-63-4T-2	52	68	76	81	83	80	73	66	HFW-90-4T-5.5	60	81	88	93	96	92	85	74
HFW-63-4T-3	53	70	78	83	85	82	77	67	HFW-90-4T-7.5	59	80	87	92	95	91	84	73
HFW-63-4T-4	54	71	79	84	86	83	78	68	HFW-90-4T-10	58	79	86	91	94	90	83	72
HFW-63-6T-0.75	42	60	68	73	75	72	65	56	HFW-90-6T-2	58	79	86	91	94	90	83	72
HFW-63-6T-1	43	62	70	75	77	74	67	57	HFW-90-6T-3	56	70	77	82	85	81	74	63
HFW-71-4T-1.5	54	74	82	87	89	86	79	69	HFW-90-6T-4	57	72	79	84	87	83	76	65
HFW-71-4T-2	53	73	81	86	88	85	78	70	HFW-100-4T-7.5	64	84	92	97	99	96	89	78
HFW-71-4T-3	58	72	80	85	87	84	77	71	HFW-100-4T-10	62	82	90	95	97	94	87	76
HFW-71-4T-4	59	73	81	86	88	85	78	72	HFW-100-4T-15	61	81	89	94	96	93	86	75
HFW-71-6T-0.75	44	63	72	74	76	73	66	55	HFW-100-4T-20	63	83	91	96	98	95	88	77
HFW-71-6T-1	45	65	73	75	77	74	67	56	HFW-100-6T-3	61	72	80	85	87	84	77	66
HFW-71-6T-1.5	46	66	71	76	78	75	68	57	HFW-100-6T-4	64	72	80	85	87	84	77	66
HFW-80-4T-3	57	77	85	90	92	89	82	73	HFW-100-6T-5.5	64	73	81	86	88	85	78	67



Erp. (Energy Related Products)

Information on Directive 2009/125/EC can be downloaded from the SODECA website or the QuickFan selector programme.

AXIAL FANS AND ROOF-MOUNTED EXTRACT FANS

Dimensions mm

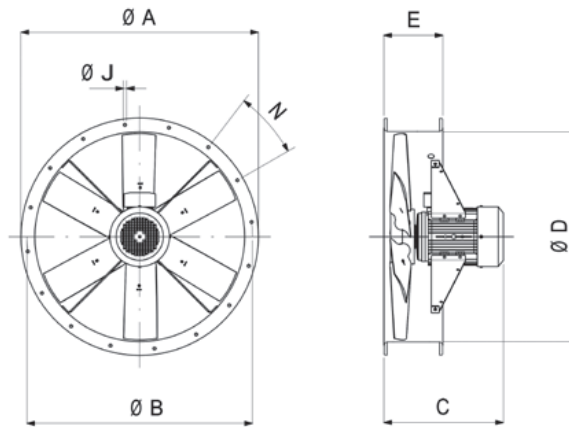

Model	ØA	ØB	C										ØD	E	ØJ	N	
			0.75	1	1.5	2	3	4	5.5	7.5	10	15					20
HFW-56-4	665	620	-	330	380	380	-	-	-	-	-	-	-	560	225	12	12x30°
HFW-56-6	665	620	330	-	-	-	-	-	-	-	-	-	-	560	225	12	12x30°
HFW-63-4	735	690	-	379	429	429	470	470	-	-	-	-	-	640	225	12	12x30°
HFW-63-6	735	690	379	429	-	-	-	-	-	-	-	-	-	640	225	12	12x30°
HFW-71-4	815	770	-	-	389	389	430	430	-	-	-	-	-	710	225	12	16x22°30'
HFW-71-6	815	770	339	389	389	-	-	-	-	-	-	-	-	710	225	12	16x22°30'
HFW-80-4	905	860	-	-	-	-	436	436	460	-	-	-	-	800	225	12	16x22°30'
HFW-80-6	905	860	-	-	395	436	460	-	-	-	-	-	-	800	225	12	16x22°30'
HFW-90-4	1018	970	-	-	-	-	401	425	485	525	-	-	-	900	225	15	16x22°30'
HFW-90-6	1018	970	-	-	-	401	425	485	-	-	-	-	-	900	225	15	16x22°30'
HFW-100-4	1118	1070	-	-	-	-	-	-	-	488	528	643	703	1000	225	15	16x22°30'
HFW-100-6	1118	1070	-	-	-	-	428	488	528	-	-	-	-	1000	225	15	16x22°30'

Characteristic curves

Q= Flow rate in m³/h, m³/s and cfm.

Pe= Static pressure in mm H₂O, Pa and inwg.

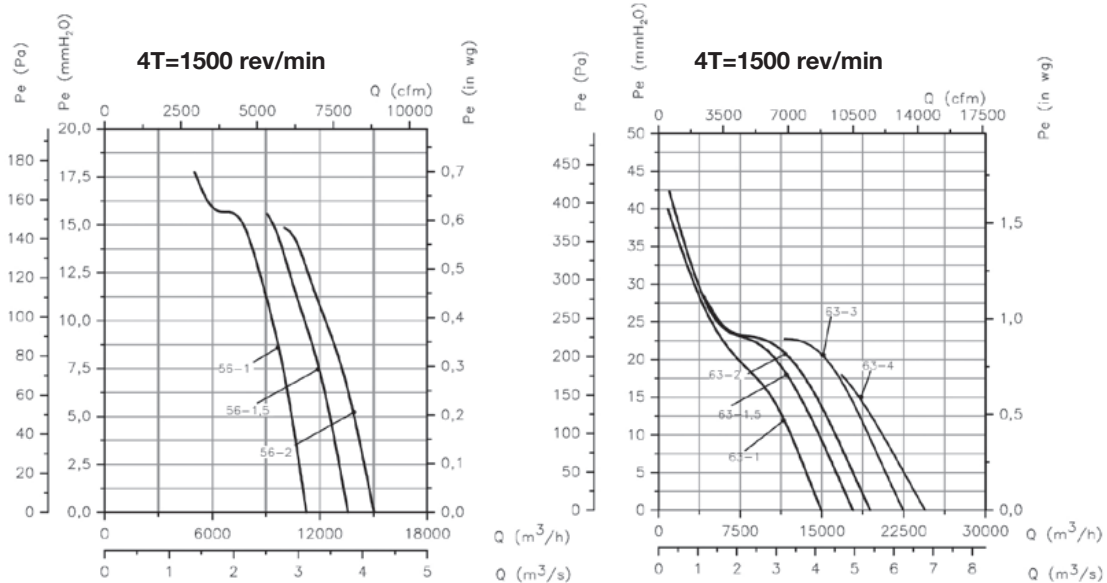

Characteristic curves

Q= Flow rate in m³/h, m³/s and cfm.

Pe= Static pressure in mm H₂O, Pa and inwg.

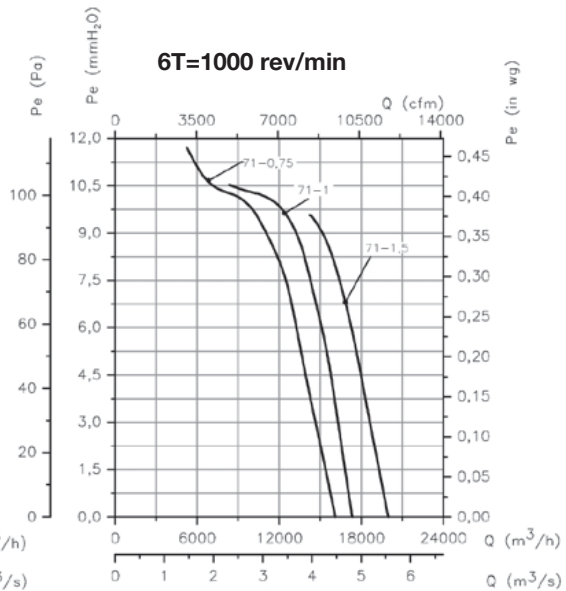
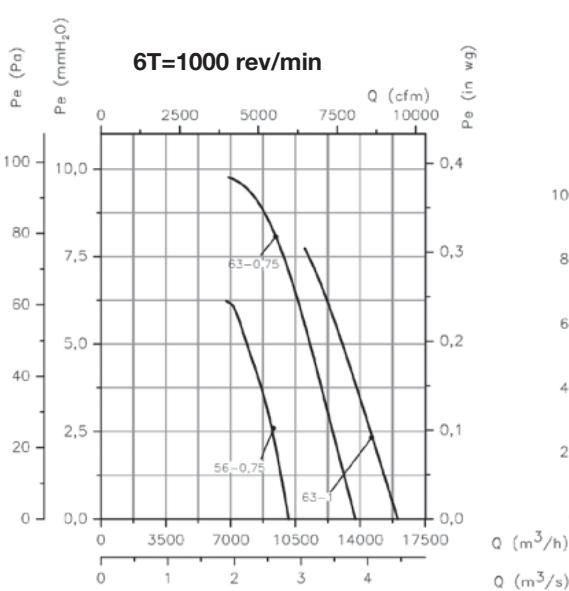
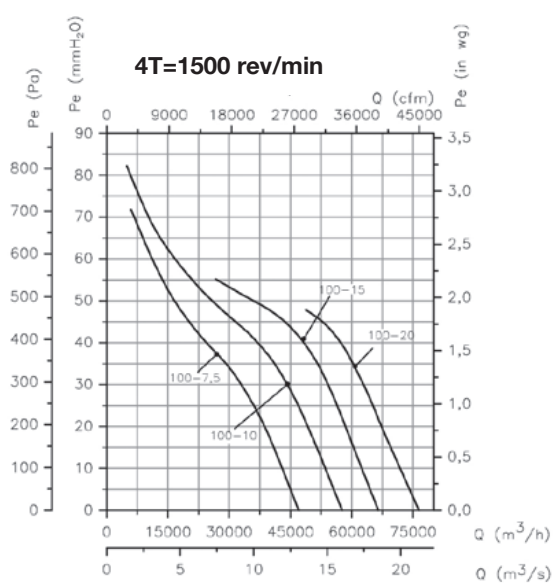
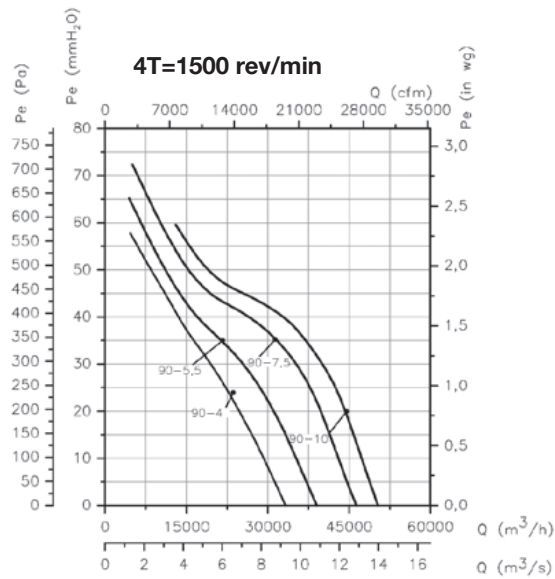
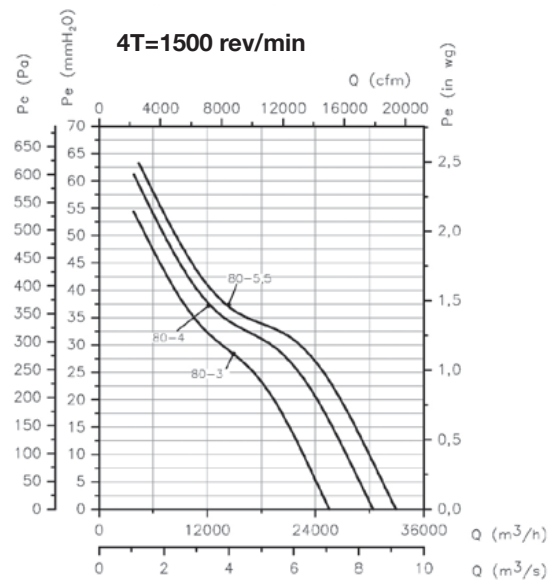
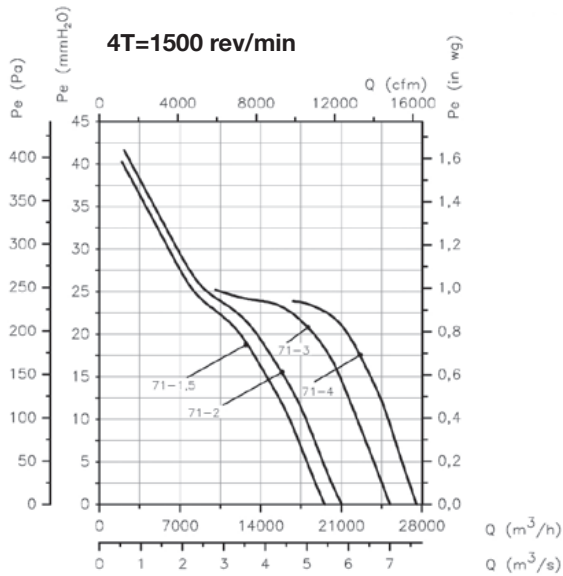

Characteristic curves

Q= Flow rate in m³/h, m³/s and cfm.

Pe= Static pressure in mm H₂O, Pa and inwg.

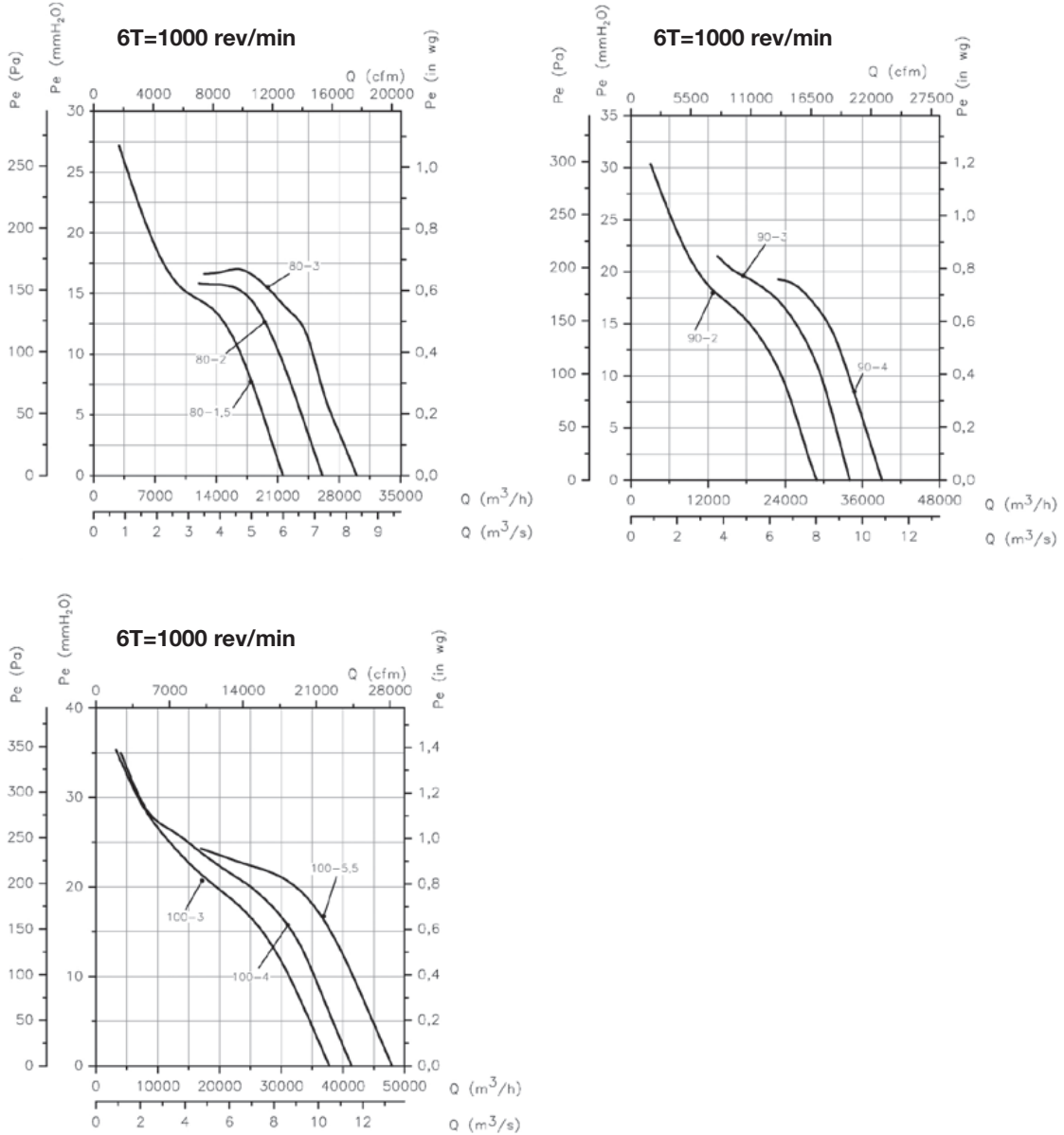

Accessories

See accessories section.

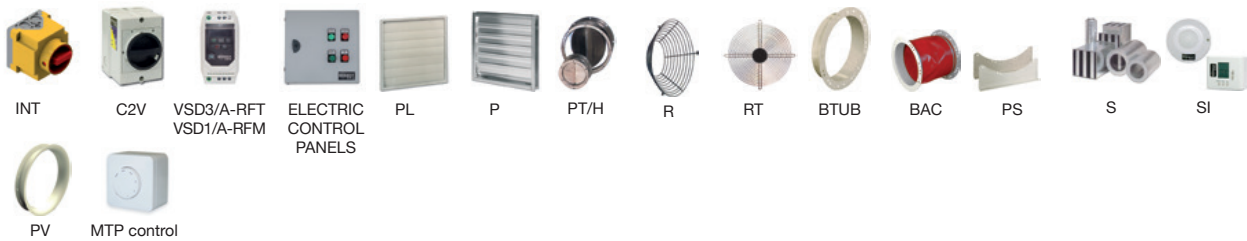

HCT/IMP

NEW

Long-range, one-way or reversible jet fans

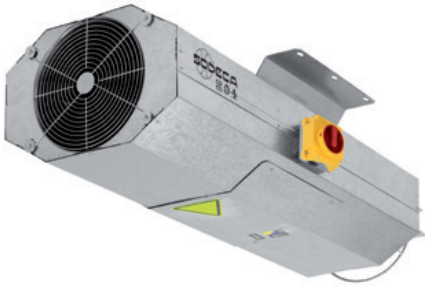

Long range one-way or reversible jet fans with an octagonal design for air movement and CO extraction in car parks.

Fan:

- One-way or reversible fan unit formed by a fan, silencers, deflectors and supports
- Adjustable impellers designed to produce great thrusts
- Anti-contact protective grille pursuant to standard UNE-EN ISO 12499 in one-way models.
- Deflector to increase the air range on the impulsion side. Reversible models are fitted with deflectors on both sides.
- High attenuation silencers with thermal and acoustic insulation.
- INT series safety switch built into the fan (HCT/IMP-L).
- Airflow direction from motor to impeller or 100% reversible.
- HCT/IMP-L: Galvanised sheet steel casing.
- HCT/IMP-LS: Short length galvanised sheet steel casing.

Motor:

- IE3 efficiency motors for powers equal to or higher than 0.75kW except single-phase, 2-speed and 8-pole.
- Class F motors with ball bearings and IP55 protection. 1 or 2 speeds, depending on model.
- Three-phase 230/400V-50Hz.
- Maximum temperature of air to be carried: -20°C+ 40°C.

Finish:

- Anti-corrosive finish on galvanised sheet steel.

On request:

- Thrust features different from those indicated.
- Version approved for smoke exhaust in accordance with standard EN 12101-3 (see THT/IMP series).

Order code

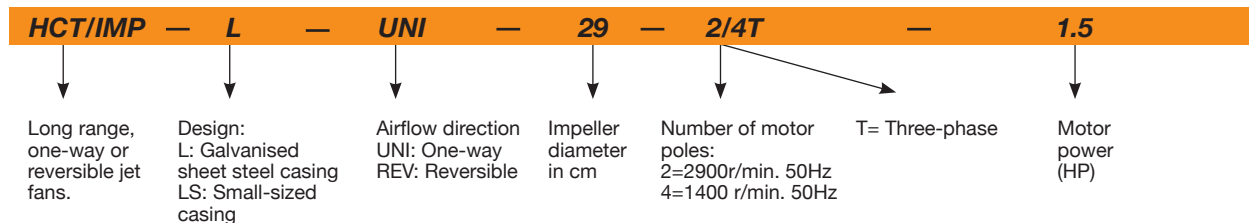

Technical characteristics

ONE-WAY

Model	Speed (r/min)	Maximum current (A)		Flow rate (m³/h)	Thrust (N)	Impulsion speed (m/s)	Installed power (kW)	Sound pressure LpA at 10 m dB(A)	Approx. weight (kg)
		230V	400 V						
HCT/IMP-L-UNI-29-2/4T	2880 / 1420	-	1.25 / 0.45	4000 / 2000	21/ 5	16.8 / 8.4	0.55 / 0.11	37 / 22	69
HCT/IMP-L-UNI-35-2/4T	2890 / 1415	-	1.90 / 0.70	6360 / 3180	36/ 9	17.8 / 8.9	0.85 / 0.20	52 / 37	70
HCT/IMP-L-UNI-38-2/4T-1.5	2905 / 1440	-	2.50 / 0.90	8450 / 4225	57/ 15	20.7 / 10.3	1.10 / 0.25	47 / 32	94
HCT/IMP-L-UNI-40-2/4T-1.5	2905 / 1440	-	2.50 / 0.90	9250 / 4625	60/ 15	20.4 / 10.2	1.10 / 0.25	53 / 38	104
HCT/IMP-L-UNI-45-2/4T-2	2935 / 1450	-	3.80 / 1.20	10800 / 5400	62/ 15	18.1 / 9.0	1.50 / 0.37	57 / 42	140
HCT/IMP-L-UNI-45-2/4T-3	2910 / 1420	-	5.00 / 1.60	13200 / 6600	92/ 23	22.1 / 11.0	2.20 / 0.60	58 / 43	141
HCT/IMP-L-UNI-50-2/4T-6	2940 / 1450	-	9.90 / 3.20	19700 / 9850	165/ 41	26.4 / 13.2	4.50 / 1.30	60 / 45	234
HCT/IMP-LS-UNI-29-2/4T	2880 / 1420	-	1.25 / 0.45	4000 / 2000	21/ 5	16.8 / 8.4	0.55 / 0.11	39 / 24	55
HCT/IMP-LS-UNI-35-2/4T	2890 / 1415	-	1.90 / 0.70	6360 / 3180	36/ 9	17.8 / 8.9	0.85 / 0.20	54 / 39	56
HCT/IMP-LS-UNI-38-2/4T-1.5	2905 / 1440	-	2.50 / 0.90	8450 / 4225	57/ 15	20.7 / 10.3	1.10 / 0.25	49 / 34	76
HCT/IMP-LS-UNI-40-2/4T-1.5	2905 / 1440	-	2.50 / 0.90	9250 / 4625	60/ 15	20.4 / 10.2	1.10 / 0.25	55 / 40	83
HCT/IMP-LS-UNI-45-2/4T-2	2935 / 1450	-	3.80 / 1.20	10800 / 5400	62/ 15	18.1 / 9.0	1.50 / 0.37	59 / 44	112
HCT/IMP-LS-UNI-45-2/4T-3	2910 / 1420	-	5.00 / 1.60	13200 / 6600	92/ 23	22.1 / 11.0	2.20 / 0.60	60 / 45	113
HCT/IMP-LS-UNI-50-2/4T-6	2940 / 1450	-	9.90 / 3.20	19700 / 9850	165/ 41	26.4 / 13.2	4.50 / 1.30	62 / 47	187

AXIAL FANS AND ROOF-MOUNTED EXTRACT FANS

Technical characteristics

Model	Speed (r/min)	Maximum current (A)		Flow rate (m³/h)	Thrust (N)	Impulsion speed (m/s)	Installed power (kW)	Sound pressure LpA at 10 m dB(A)	Approx. weight (kg)
		230V	400 V						
HCT/IMP-L-UNI-29-2T-0.75	2760	2.57	1.49	4000	21	16.8	0.55	37	73
HCT/IMP-L-UNI-35-2T-1.5 IE3	2830	4.03	2.32	6360	36	17.8	1.1	52	76
HCT/IMP-L-UNI-38-2T-1.5 IE3	2830	4.03	2.32	8450	57	20.7	1.1	47	98
HCT/IMP-L-UNI-40-2T-1.5 IE3	2830	4.03	2.32	9250	60	20.4	1.1	53	108
HCT/IMP-L-UNI-45-2T-2 IE3	2875	5.34	3.07	10800	62	18.1	1.5	57	145
HCT/IMP-L-UNI-45-2T-3 IE3	2910	7.32	4.21	13200	92	22.1	2.2	58	156
HCT/IMP-L-UNI-50-2T-5.5 IE3	2900	13.00	7.50	19700	165	26.4	4	60	242
HCT/IMP-LS-UNI-29-2T-0.75	2760	2.57	1.49	4000	21	16.8	0.55	39	59
HCT/IMP-LS-UNI-35-2T-1.5 IE3	2830	4.03	2.32	6360	36	17.8	1.1	54	62
HCT/IMP-LS-UNI-38-2T-1.5 IE3	2830	4.03	2.32	8450	57	20.7	1.1	49	80
HCT/IMP-LS-UNI-40-2T-1.5 IE3	2830	4.03	2.32	9250	60	20.4	1.1	55	87
HCT/IMP-LS-UNI-45-2T-2 IE3	2875	5.34	3.07	10800	62	18.1	1.5	59	117
HCT/IMP-LS-UNI-45-2T-3 IE3	2910	7.32	4.21	13200	92	22.1	2.2	60	128
HCT/IMP-LS-UNI-50-2T-5.5 IE3	2900	13.00	7.50	19700	165	26.4	4	62	195
HCT/IMP-L-UNI-29-4T-0.12	1320	0.65	0.38	1550	3	6.5	0.09	26	63
HCT/IMP-L-UNI-35-4T-0.12	1320	0.65	0.38	3210	10	9.3	0.09	33	59
HCT/IMP-L-UNI-38-4T-0.25	1350	1.23	0.71	4440	16	10.9	0.18	36	86
HCT/IMP-L-UNI-40-4T-0.33	1350	1.66	0.96	5170	20	11.4	0.25	38	96
HCT/IMP-L-UNI-45-4T-0.33	1350	1.66	0.96	5960	21	10.4	0.25	42	129
HCT/IMP-L-UNI-45-4T-0.5	1370	2.02	1.17	7100	29	12.4	0.37	43	118
HCT/IMP-L-UNI-50-4T-0.75	1380	2.92	1.69	10380	51	14.7	0.55	47	203
HCT/IMP-LS-UNI-29-4T-0.12	1320	0.65	0.38	1550	3	6.5	0.09	28	49
HCT/IMP-LS-UNI-35-4T-0.12	1320	0.65	0.38	3210	10	9.3	0.09	35	45
HCT/IMP-LS-UNI-38-4T-0.25	1350	1.23	0.71	4440	16	10.9	0.18	38	68
HCT/IMP-LS-UNI-40-4T-0.33	1350	1.66	0.96	5170	20	11.4	0.25	40	75
HCT/IMP-LS-UNI-45-4T-0.33	1350	1.66	0.96	5960	21	10.4	0.25	44	101
HCT/IMP-LS-UNI-45-4T-0.5	1370	2.02	1.17	7100	29	12.4	0.37	45	90
HCT/IMP-LS-UNI-50-4T-0.75	1380	2.92	1.69	10380	51	14.7	0.55	49	156

REVERSIBLE

Model	Speed (r/min)	Maximum current (A)		Flow rate (m³/h)	Thrust (N)	Impulsion speed (m/s)	Installed power (kW)	Sound pressure LpA at 10 m dB(A)	Approx. weight (kg)
		230V	400 V						
HCT/IMP-L-REV-29-2/4T	2880 / 1420	-	1.25 / 0.45	3400 / 1700	15/ 4	14.3 / 7.1	0.55 / 0.11	38 / 23	67
HCT/IMP-L-REV-35-2/4T	2890 / 1415	-	1.90 / 0.70	5940 / 2970	31/ 8	16.7 / 8.3	0.85 / 0.20	51 / 36	70
HCT/IMP-L-REV-38-2/4T-2	2935 / 1450	-	3.80 / 1.20	8200 / 4100	54/ 14	20.1 / 10.0	1.50 / 0.37	49 / 34	97
HCT/IMP-L-REV-40-2/4T-2	2935 / 1450	-	3.80 / 1.20	9250 / 4625	60/ 15	20.4 / 10.2	1.50 / 0.37	52 / 37	106
HCT/IMP-L-REV-45-2/4T-2	2935 / 1450	-	3.80 / 1.20	10300 / 5150	56/ 14	17.2 / 8.6	1.50 / 0.37	56 / 41	139
HCT/IMP-L-REV-45-2/4T-3	2910 / 1420	-	5.00 / 1.60	12800 / 6400	87/ 22	21.4 / 10.7	2.20 / 0.60	57 / 42	141
HCT/IMP-L-REV-50-2/4T-6	2940 / 1450	-	9.90 / 3.20	19000 / 9500	153/ 38	25.4 / 12.7	4.50 / 1.30	60 / 45	284
HCT/IMP-LS-REV-29-2/4T	2880 / 1420	-	1.25 / 0.45	3400 / 1700	15/ 4	14.3 / 7.1	0.55 / 0.11	40 / 25	55
HCT/IMP-LS-REV-35-2/4T	2890 / 1415	-	1.90 / 0.70	5940 / 2970	31/ 8	16.7 / 8.3	0.85 / 0.20	53 / 38	56
HCT/IMP-LS-REV-38-2/4T-2	2935 / 1450	-	3.80 / 1.20	8200 / 4100	54/ 14	20.1 / 10.0	1.50 / 0.37	51 / 36	77
HCT/IMP-LS-REV-40-2/4T-2	2935 / 1450	-	3.80 / 1.20	9250 / 4625	60/ 15	20.4 / 10.2	1.50 / 0.37	53 / 39	85
HCT/IMP-LS-REV-45-2/4T-2	2935 / 1450	-	3.80 / 1.20	10300 / 5150	56/ 14	17.2 / 8.6	1.50 / 0.37	58 / 43	111
HCT/IMP-LS-REV-45-2/4T-3	2910 / 1420	-	5.00 / 1.60	12800 / 6400	87/ 22	21.4 / 10.7	2.20 / 0.60	59 / 44	113
HCT/IMP-LS-REV-50-2/4T-6	2940 / 1450	-	9.90 / 3.20	19000 / 9500	153/ 38	25.4 / 12.7	4.50 / 1.30	62 / 47	227
HCT/IMP-L-REV-29-2T-0.75	2760	2.57	1.49	3400	15	14.3	0.55	38	71
HCT/IMP-L-REV-35-2T-1.5 IE3	2830	4.03	2.32	5940	31	16.7	1.1	51	76
HCT/IMP-L-REV-38-2T-2 IE3	2875	5.34	3.07	8200	54	20.1	1.5	49	102
HCT/IMP-L-REV-40-2T-2 IE3	2875	5.34	3.07	9250	60	20.4	1.5	52	111
HCT/IMP-L-REV-45-2T-2 IE3	2875	5.34	3.07	10300	56	17.2	1.5	56	144
HCT/IMP-L-REV-45-2T-3 IE3	2910	7.32	4.21	12800	87	21.4	2.2	57	156
HCT/IMP-L-REV-50-2T-5.5 IE3	2900	13.00	7.50	19000	153	25.4	4	60	292
HCT/IMP-LS-REV-29-2T-0.75	2760	2.57	1.49	3400	15	14.3	0.55	40	59
HCT/IMP-LS-REV-35-2T-1.5 IE3	2830	4.03	2.32	5940	31	16.7	1.1	53	62
HCT/IMP-LS-REV-38-2T-2 IE3	2875	5.34	3.07	8200	54	20.1	1.5	51	82
HCT/IMP-LS-REV-40-2T-2 IE3	2875	5.34	3.07	9250	60	20.4	1.5	53	90
HCT/IMP-LS-REV-45-2T-2 IE3	2875	5.34	3.07	10300	56	17.2	1.5	58	116

Technical characteristics

Model	Speed (r/min)	Maximum current (A)		Flow rate (m ³ /h)	Thrust (N)	Impulsion speed (m/s)	Installed power (kW)	Sound pressure LpA at 10 m dB(A)	Approx. weight (kg)
		230V	400 V						
HCT/IMP-LS-REV-45-2T-3 IE3	2910	7.32	4.21	12800	87	21.4	2.2	59	128
HCT/IMP-LS-REV-50-2T-5.5 IE3	2900	13.00	7.50	19000	153	25.4	4	62	235
HCT/IMP-L-REV-29-4T-0.12	1320	0.65	0.38	1475	3	6.2	0.09	27	61
HCT/IMP-L-REV-35-4T-0.12	1320	0.65	0.38	3050	9	8.8	0.09	34	59
HCT/IMP-L-REV-38-4T-0.33	1350	1.66	0.96	4220	15	10.3	0.25	37	86
HCT/IMP-L-REV-40-4T-0.33	1350	1.66	0.96	4910	18	10.9	0.25	39	95
HCT/IMP-L-REV-45-4T-0.33	1350	1.66	0.96	5660	19	9.9	0.25	43	128
HCT/IMP-L-REV-45-4T-0.5	1370	2.02	1.17	6745	26	11.8	0.37	44	118
HCT/IMP-L-REV-50-4T-0.75	1380	2.92	1.69	9860	46	13.9	0.55	48	253
HCT/IMP-LS-REV-29-4T-0.12	1320	0.65	0.38	1475	3	6.2	0.09	29	49
HCT/IMP-LS-REV-35-4T-0.12	1320	0.65	0.38	3050	9	8.8	0.09	36	45
HCT/IMP-LS-REV-38-4T-0.33	1350	1.66	0.96	4220	15	10.3	0.25	39	66
HCT/IMP-LS-REV-40-4T-0.33	1350	1.66	0.96	4910	18	10.9	0.25	41	74
HCT/IMP-LS-REV-45-4T-0.33	1350	1.66	0.96	5660	19	9.9	0.25	45	100
HCT/IMP-LS-REV-45-4T-0.5	1370	2.02	1.17	6745	26	11.8	0.37	46	90
HCT/IMP-LS-REV-50-4T-0.75	1380	2.92	1.69	9860	46	13.9	0.55	50	196

Dimensions mm

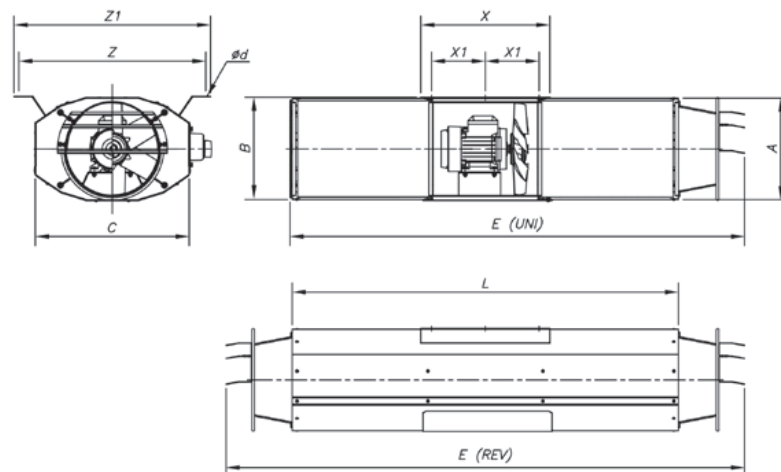

Model	A	B	C	ød	E (UNI)	E (REV)	L	X	X1	Z	Z1
HCT/IMP-LS-29	319.5	324	479	12x26	1410	1610	1200	400	167	580	610
HCT/IMP-L-29	319.5	324	479	12x26	2210	2410	2000	400	167	580	610
HCT/IMP-LS-35	383	386	523	12x26	1410	1610	1200	400	167	614	644
HCT/IMP-L-35	383	386	523	12x26	2210	2410	2000	400	167	614	644
HCT/IMP-LS-38	406	409	550	12x26	1410	1610	1200	400	170	640	670
HCT/IMP-L-38	406	409	550	12x26	2210	2410	2000	400	170	640	670
HCT/IMP-LS-40	436	439	582	12x26	1410	1610	1200	400	170	670	700
HCT/IMP-L-40	436	439	582	12x26	2210	2410	2000	400	170	670	700
HCT/IMP-LS-45	486	489	630	12x26	1410	1610	1200	400	170	724	754
HCT/IMP-L-45	486	489	630	12x26	2210	2410	2000	400	170	724	754
HCT/IMP-LS-50	546	549	742	12x26	1445	1675	1200	580	255	778	808
HCT/IMP-L-50	546	549	742	12x26	2245	2475	2000	580	255	778	808

HCT/IMP-C



Long-range, circular, one-way or reversible jet fans



Long range one-way or reversible jet fans with a circular design for air movement and CO extraction in car parks.

Fan:

- One-way or reversible fan unit formed by a fan, silencers, deflectors and supports.
- Adjustable impellers designed to produce great thrusts.
- Anti-contact protective grille pursuant to standard UNE-EN ISO 12499 in one-way models.
- Deflector to increase the air range on the impulsion side. Reversible models are fitted with deflectors on both sides.
- High attenuation silencers with thermal and acoustic insulation.
- Airflow direction from motor to impeller or 100% reversible.
- Circular casing in painted sheet steel.

Motor:

- IE3 efficiency motors for powers equal to or higher than 0.75kW except single-phase, 2-speed and 8-pole.
- Class F motors with ball bearings and IP55 protection. 1 or 2 speeds, depending on model.
- Three-phase 230/400V-50Hz.
- Maximum temperature of air to be carried: -20°C+ 40°C.

Finish:

- Anti-corrosive finish of polyester resin polymerised at 190 °C, previously degreased with phosphate-free nanotechnological treatment.

On request:

- Thrust features different from those indicated.
- Version approved for smoke exhaust in accordance with standard EN 12101-3 (see THT/IMP series).
- INT series safety switch built into the fan.

Order code

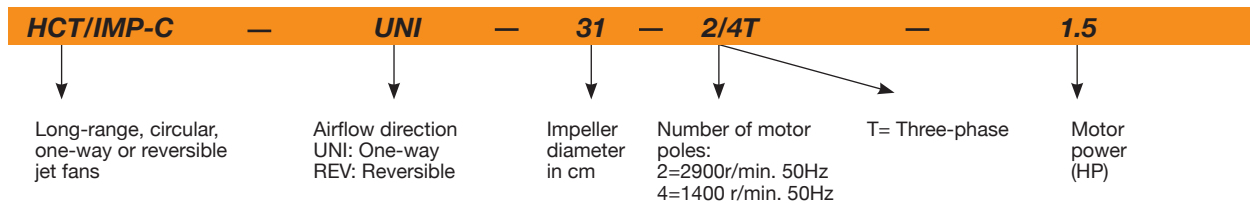

Technical characteristics

ONE-WAY

Model	Speed (r/min)	Maximum current (A) (A)	Flow rate (m3/h)	Thrust (N)	Impulsion speed (m/s)	Installed power (kW)	Sound pressure LpA at 10 m dB(A)	Approx. weight (kg)
HCT/IMP-C-UNI-31-2/4T	2860 / 1430	1.50 / 0.55	4260 / 2130	21/ 5	15.6 / 7.8	0.55 / 0.15	51 / 36	65
HCT/IMP-C-UNI-35-2/4T	2875 / 1430	2.10 / 0.80	6360 / 3180	36/ 9	17.8 / 8.9	0.85 / 0.20	52 / 37	70
HCT/IMP-C-UNI-38-2/4T-1.5	2900 / 1450	2.90 / 1.10	8450 / 4225	57/ 15	20.7 / 10.3	1.10 / 0.25	47 / 32	89
HCT/IMP-C-UNI-40-2/4T-1.5	2900 / 1450	2.90 / 1.10	9250 / 4625	60/ 15	20.4 / 10.2	1.10 / 0.25	53 / 38	98
HCT/IMP-C-UNI-45-2/4T-2	2940 / 1460	4.40 / 1.40	10800 / 5400	62/ 15	18.1 / 9.0	1.50 / 0.37	57 / 42	132
HCT/IMP-C-UNI-45-2/4T-3	2930 / 1450	5.70 / 1.80	13200 / 6600	92/ 23	22.1 / 11.0	2.20 / 0.60	58 / 43	133
HCT/IMP-C-UNI-50-2/4T-6	2930 / 1450	10.00 / 3.20	19700 / 9850	165/ 41	26.4 / 13.2	4.50 / 1.30	60 / 45	220

Technical characteristics

REVERSIBLE

Model	Speed (r/min)	Maximum current (A) (A)	Flow rate (m ³ /h)	Thrust (N)	Impulsion speed (m/s)	Installed power (kW)	Sound pressure LpA at 10 m dB(A)	Approx. weight (kg)
HCT/IMP-C-REV-31-2/4T	2860 / 1430	1.50 / 0.55	3840 / 1920	17 / 4	14.1 / 7.0	0.55 / 0.15	50 / 35	63
HCT/IMP-C-REV-35-2/4T	2875 / 1430	2.10 / 0.80	5940 / 2970	31 / 8	16.7 / 8.3	0.85 / 0.20	51 / 36	70
HCT/IMP-C-REV-38-2/4T-2	2940 / 1460	4.40 / 1.40	8200 / 4100	54 / 14	20.1 / 10.0	1.50 / 0.37	49 / 34	91
HCT/IMP-C-REV-40-2/4T-2	2940 / 1460	4.40 / 1.40	9250 / 4625	60 / 15	20.4 / 10.2	1.50 / 0.37	52 / 37	100
HCT/IMP-C-REV-45-2/4T-2	2940 / 1460	4.40 / 1.40	10300 / 5150	56 / 14	17.2 / 8.6	1.50 / 0.37	56 / 41	131
HCT/IMP-C-REV-45-2/4T-3	2930 / 1450	5.70 / 1.80	12800 / 6400	87 / 22	21.4 / 10.7	2.20 / 0.60	57 / 42	133
HCT/IMP-C-REV-50-2/4T-6	2930 / 1450	10.00 / 3.20	19000 / 9500	153 / 38	25.4 / 12.7	4.50 / 1.30	60 / 45	267

Dimensions mm

HCT/IMP-C- 31...45

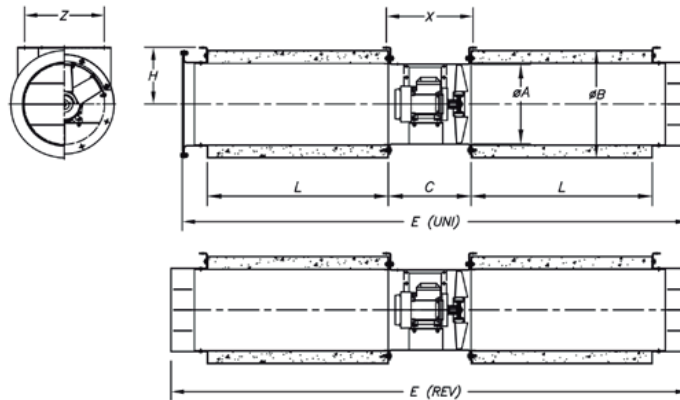

Model	ØA	ØB	C	L	Ød	E (UNI)	E (REV)	H	X	Z
HCT/IMP-C-31	315	415	320	700	10	1956	2000	220	345	275
HCT/IMP-C-35	355	460	325	700	12	1960	2005	250	346	300
HCT/IMP-C-38	380	460	340	1000	12	2570	2620	250	530	517
HCT/IMP-C-40	410	510	340	950	12	2485	2540	280	376	340
HCT/IMP-C-45	460	630	360	950	12	2500	2554	355	396	440

HCT/IMP-C- 50

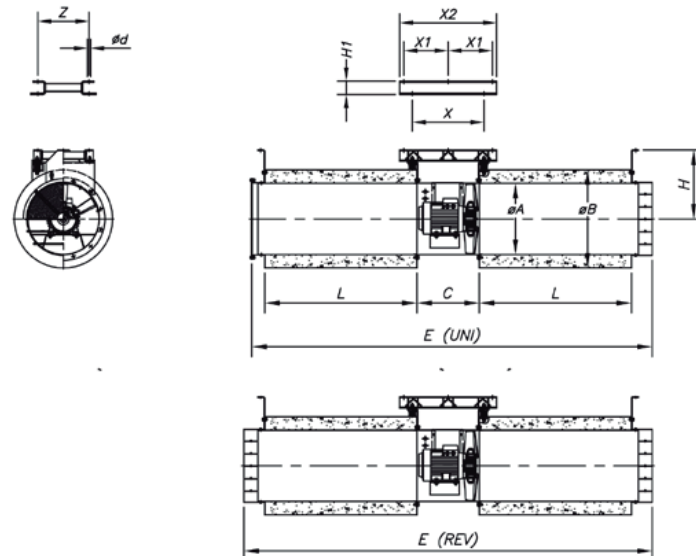

Model	ØA	ØB	C	L	Ød	E (UNI)	E (REV)	H	H1	X	X1	X2	Z
HCT/IMP-C-50	514	710	450	1100	12	2895	2950	498	80	518	320	700	370

CJHCH



Axial ventilation units with acoustically-isolated boxes



Ventilation units with interior acoustic insulation and dismantable inspection hatches.

Fan:

- Galvanised sheet steel structure with thermal and acoustic insulation.
- Fibreglass-reinforced polyamide-6 impellers.
- Ventilation units prepared for vertical or horizontal work.
- Airflow direction from motor to impeller.

Motor:

- IE3 efficiency motors for powers equal to or higher than 0.75kW except single-phase, 2-speed and 8-pole.
- Class F motors with ball bearings and IP55 protection, except single-phase, from size 45 to 56, with IP54 protection. 1 or 2 speeds, depending on model.

- Single-phase 230V-50Hz and three-phase 230/400V-50Hz (up to 4kW) and 400/690V-50Hz (powers higher than 4kW).
- Operating temperature: -25°C+ 50°C.

Finish:

- Anti-corrosive finish on galvanised sheet steel.

On request:

- Impellers made of cast aluminium.
- Airflow direction from impeller to motor.
- 100% reversible impellers.
- Special windings for different voltages.

Order code

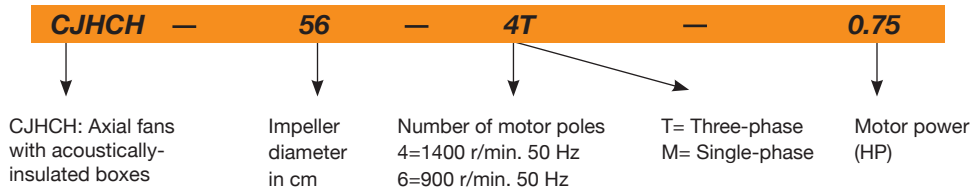

Technical characteristics

Model	Speed (r/min)	Maximum admissible current (A)		Installed power (kW)	Maximum flow rate (m³/h)	Sound pressure level dB(A)	Approx. weight (kg)	According to ErP
		230V	400V 690V					
CJHCH-56-4T-0.75	1380	2.92	1.69	0.55	11050	69	52	2015
CJHCH-56-4T-1 IE3	1420	2.82	1.62	0.75	12950	70	54	2015
CJHCH-56-4T-1.5 IE3	1455	4.07	2.34	1.10	14000	71	61	2015
CJHCH-56-4T-2 IE3	1440	5.41	3.11	1.50	15300	72	67	2015
CJHCH-56-6T-0.33	900	1.51	0.87	0.25	8500	59	49	2015
CJHCH-56-6T-0.5	900	2.24	1.30	0.37	9300	59	51	2015
CJHCH-56-6T-0.75	900	2.99	1.73	0.55	10000	60	53	2015
CJHCH-63-4T-1 IE3	1420	2.82	1.62	0.75	14150	70	59	2015
CJHCH-63-4T-1.5 IE3	1455	4.07	2.34	1.10	17000	71	65	2015
CJHCH-63-4T-2 IE3	1440	5.41	3.11	1.50	18900	72	72	2015
CJHCH-63-4T-3 IE3	1435	7.93	4.56	2.20	22100	73	73	2015
CJHCH-63-4T-4 IE3	1440	10.70	6.15	3.00	25400	74	79	2015
CJHCH-63-6T-0.5	900	2.24	1.30	0.37	12150	62	56	2015
CJHCH-63-6T-0.75	900	2.99	1.73	0.55	12750	63	58	2015
CJHCH-63-6T-1 IE3	940	3.36	1.93	0.75	13800	64	67	*
CJHCH-71-4T-1.5 IE3	1455	4.07	2.34	1.10	19750	75	81	2015
CJHCH-71-4T-2 IE3	1440	5.41	3.11	1.50	21100	76	88	2015
CJHCH-71-4T-3 IE3	1435	7.93	4.56	2.20	23950	78	90	2015
CJHCH-71-4T-4 IE3	1440	10.70	6.15	3.00	29400	79	96	2015
CJHCH-71-6T-0.75	900	2.99	1.73	0.55	15150	65	73	2015
CJHCH-71-6T-1 IE3	940	3.36	1.93	0.75	17250	66	83	2015
CJHCH-71-6T-1.5 IE3	945	4.68	2.69	1.10	20950	67	88	2015

Technical characteristics

Model	Speed (r/min)	Maximum admissible current (A)			Installed power (kW)	Maximum flow rate (m³/h)	Sound pressure level dB(A)	Approx. weight (kg)	According to ErP
		230V	400V	690V					
CJHCH-80-4T-3 IE3	1435	7.93	4.56		2.20	28000	79	98	2015
CJHCH-80-4T-4 IE3	1440	10.70	6.15		3.00	32700	80	104	2015
CJHCH-80-4T-5.5 IE3	1450	13.90	8.00		4.00	37200	81	106	2015
CJHCH-80-6T-1 IE3	940	3.36	1.93		0.75	20600	69	91	2015
CJHCH-80-6T-1.5 IE3	945	4.68	2.69		1.10	24250	70	96	2015
CJHCH-80-6T-2 IE3	950	6.43	3.70		1.50	28000	71	100	2015
CJHCH-80-6T-3 IE3	950	9.08	5.22		2.20	32500	72	105	2015
CJHCH-90-4T-4 IE3	1440	10.70	6.15		3.00	37750	84	128	2015
CJHCH-90-4T-5.5 IE3	1450	13.90	8.00		4.00	41850	86	130	2015
CJHCH-90-4T-7.5 IE3	1465		10.30	5.97	5.50	47000	88	167	2015
CJHCH-90-4T-10 IE3	1465		13.90	8.06	7.50	53000	89	171	2015
CJHCH-90-6T-3 IE3	950	9.08	5.22		2.20	35000	76	129	2015
CJHCH-90-6T-4 IE3	970	12.00	6.91		3.00	40000	77	149	2015
CJHCH-100-4T-7.5 IE3	1465		10.30	5.97	5.50	52500	89	175	2015
CJHCH-100-4T-10 IE3	1465		13.90	8.06	7.50	58500	90	179	2015
CJHCH-100-4T-15 IE3	1470		20.90	12.10	11.00	68000	91	211	2015
CJHCH-100-4T-20 IE3	1465		27.90	16.20	15.00	71850	92	222	2015
CJHCH-100-6T-3 IE3	950	9.08	5.22		2.20	40500	80	137	2015
CJHCH-100-6T-4 IE3	970	12.00	6.91		3.00	46950	81	157	2015
CJHCH-100-6T-5.5 IE3	960	15.60	8.99		4.00	52000	82	163	2015

* Equipment not covered by Directive 2009/125/EC

Acoustic characteristics

The indicated values are determined by measuring the sound pressure level and sound power in dB(A) obtained in a free field at a distance equivalent to twice the size of the fan plus the impeller diameter, with a minimum of 1.5 m.

Sound power spectrum Lw(A) in dB(A) per Hz frequency band

Model	63	125	250	500	1000	2000	4000	8000	Model	63	125	250	500	1000	2000	4000	8000
56-4-0.75	44	64	72	77	79	76	69	58	71-6-1.5	44	64	72	77	79	76	69	58
56-4-1	45	65	73	78	80	77	70	59	80-4-3	56	76	84	89	91	88	81	70
56-4-1.5	46	66	74	79	81	78	71	60	80-4-4	57	77	85	90	92	89	82	71
56-4-2	47	67	75	80	82	79	72	61	80-4-5.5	58	78	86	91	93	90	83	72
56-6-0.33	34	54	62	67	69	66	59	48	80-6-1	46	66	74	79	81	78	71	60
56-6-0.5	34	54	62	67	69	66	59	48	80-6-1.5	47	67	75	80	82	79	72	61
56-6-0.75	35	55	63	68	70	67	60	49	80-6-2	48	68	76	81	83	80	73	62
63-4-1	47	67	75	80	82	79	72	61	80-6-3	49	69	77	82	84	81	74	63
63-4-1.5	48	68	76	81	83	80	73	62	90-4-4	62	83	90	95	98	94	87	76
63-4-2	49	69	77	82	84	81	74	63	90-4-5.5	64	85	92	97	100	96	89	78
63-4-3	50	70	78	83	85	82	75	64	90-4-7.5	66	87	94	99	102	98	91	80
63-4-4	51	71	79	84	86	83	76	65	90-4-10	67	88	95	100	103	99	92	81
63-6-0.5	39	59	67	72	74	71	64	53	90-6-3	54	75	82	87	90	86	79	68
63-6-0.75	40	60	68	73	75	72	65	54	90-6-4	55	76	83	88	91	87	80	69
63-6-1	41	61	69	74	76	73	66	55	100-4-7.5	69	89	97	102	104	101	94	83
71-4-1.5	52	72	80	85	87	84	77	66	100-4-10	70	90	98	103	105	102	95	84
71-4-2	53	73	81	86	88	85	78	67	100-4-15	71	91	99	104	106	103	96	85
71-4-3	55	75	83	88	90	87	80	69	100-4-20	72	92	100	105	107	104	97	86
71-4-4	56	76	84	89	91	88	81	70	100-6-3	60	80	88	93	95	92	85	74
71-6-0.75	42	62	70	75	77	74	67	56	100-6-4	61	81	89	94	96	93	86	75
71-6-1	43	63	71	76	78	75	68	57	100-6-5.5	62	82	90	95	97	94	87	76

Dimensions mm

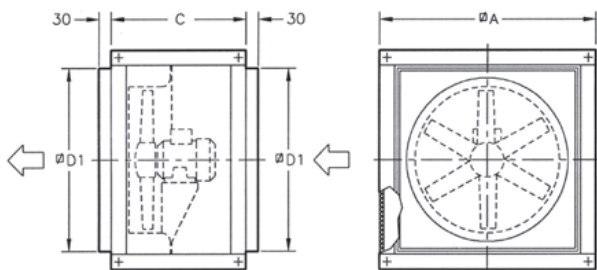

Model	ØA	C	ØD1
CJHCH-56/63	825	550	690
CJHCH-71/80	1000	650	850
CJHCH-90/100	1200	750	1050



Erp. (Energy Related Products)

Information on Directive 2009/125/EC can be downloaded from the SODECA website or the QuickFan selector programme.

Characteristic curves

See HCH-HCT series curves.

Accessories

See accessories section.



HTP *High pressure tubular axial extract fans*



High pressure impeller

Extremely robust, high pressure, tubular axial fans, specially designed for mining installations or in applications with large load losses.

Fan:

- Extremely thick tubular sheet steel casing.
- Motor support welded to casing.
- High aerodynamic performance directives for pressure gains
- Optimal surface protection in high quality steel.
- High performance, cast aluminium impeller.
- Impeller to motor air direction.
- Electrical connection in external terminal box.

Motor:

- IE3 efficiency motors for powers equal to or higher than 0.75kW except single-phase, 2-speed and 8-pole.

- Class F motors with ball bearings and IP55 protection.
- Three-phase 230/400V-50Hz (up to 4kW) and 400/690V-50Hz (powers higher than 4kW).
- Operating temperature -20°C +70°C.

Finish:

- High protection anti-corrosive steel, special primer and high quality paint for corrosive atmospheres.

On request:

- Standard IP55, ATEX and 2-speed motors.
- Made entirely of stainless steel.
- Made of hot dip galvanised steel.



Order code

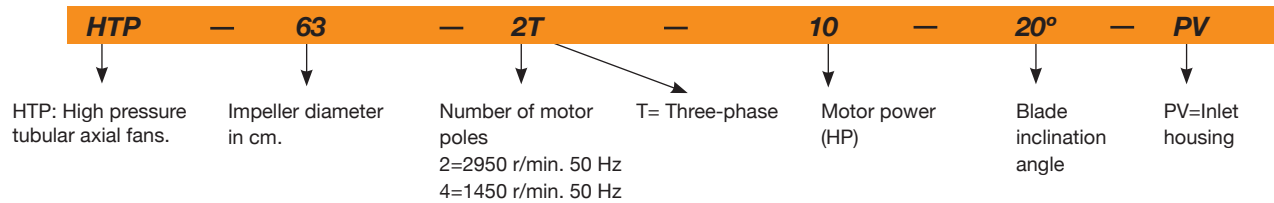

Technical characteristics

Model	Speed (r/min)	Maximum admissible current (A)			Installed power (kW)	Maximum flow rate (m³/h)	Sound pressure level dB(A)	Approx. weight (kg)	According to ErP
		230V	400V	690V					
HTP-50-2T-4 IE3	2910	10.00	5.77		3.00	13850	86	49	2015
HTP-50-2T-5.5 IE3	2900	13.00	7.50		4.00	16450	92	65	2015
HTP-56-2T-5.5 IE3	2900	13.00	7.50		4.00	18050	97	69	2015
HTP-56-2T-10 IE3	2930		14.10	8.17	7.50	25500	89	143	2015
HTP-63-2T-10 IE3	2930		14.10	8.17	7.50	23850	94	128	2015
HTP-63-2T-15 IE3	2945		20.00	11.60	11.00	29400	94	199	2015
HTP-63-2T-20 IE3	2945		27.70	16.10	15.00	34400	97	205	2015
HTP-63-2T-25 IE3	2945		33.90	19.70	18.50	37200	98	216	2015
HTP-63-2T-30 IE3	2950		39.70	23.00	22.00	39800	99	208	2015
HTP-63-4T-1.5 IE3	1455	4.07	2.34		1.10	12850	83	92	2015
HTP-63-4T-2 IE3	1440	5.41	3.11		1.50	15650	87	93	2015
HTP-63-4T-3 IE3	1435	7.93	4.56		2.20	18600	84	101	2015
HTP-63-4T-4 IE3	1440	10.70	6.15		3.00	19900	89	104	2015
HTP-71-2T-15 IE3	2945		20.00	11.60	11.00	32850	93	216	2015
HTP-71-2T-20 IE3	2945		27.70	16.10	15.00	39250	95	222	2015
HTP-71-2T-25 IE3	2945		33.90	19.70	18.50	43450	95	233	2015
HTP-71-2T-30 IE3	2950		39.70	23.00	22.00	45500	95	225	2015
HTP-71-2T-40 IE3	2960		54.50	31.60	30.00	52550	98	333	2015
HTP-71-4T-2 IE3	1435	7.93	4.56		2.20	17500	84	110	2015
HTP-71-4T-3 IE3	1435	7.93	4.56		2.20	20650	84	118	2015
HTP-71-4T-4 IE3	1440	10.70	6.15		3.00	23950	89	121	2015

Technical characteristics

Model	Speed (r/min)	Maximum admissible current (A)			Installed power (kW)	Maximum flow rate (m³/h)	Sound pressure level dB(A)	Approx. weight (kg)	According to ErP
		230V	400V	690V					
HTP-71-4T-5.5 IE3	1450	13.90	8.00		4.00	27400	89	127	2015
HTP-71-4T-7.5 IE3	1465		10.30	5.97	5.50	31700	113	141	2015
HTP-80-4T-4 IE3	1440	10.70	6.15		3.00	19300	91	146	2015
HTP-80-4T-5.5 IE3	1450	13.90	8.00		4.00	22850	88	152	2015
HTP-80-4T-7.5 IE3	1465		10.30	5.97	5.50	28000	109	166	2015
HTP-80-4T-10 IE3	1465		13.90	8.06	7.50	31500	87	193	2015
HTP-80-4T-15 IE3	1470		20.90	12.10	11.00	40000	91	242	2015
HTP-90-4T-7.5 IE3	1465		10.30	5.97	5.50	27450	113	196	2015
HTP-90-4T-10 IE3	1465		13.90	8.06	7.50	32500	90	223	2015
HTP-90-4T-15 IE3	1470		20.90	12.10	11.00	42200	90	272	2015
HTP-90-4T-20 IE3	1465		27.90	16.20	15.00	50050	94	283	2015
HTP-90-4T-25 IE3	1470		35.10	20.30	18.50	54550	95	326	2015
HTP-90-4T-30 IE3	1470		41.00	23.80	22.00	61750	97	326	2015
HTP-100-4T-15 IE3	1470		20.90	12.10	11.00	46100	93	307	2015
HTP-100-4T-20 IE3	1465		27.90	16.20	15.00	56300	93	318	2015
HTP-100-4T-25 IE3	1470		35.10	20.30	18.50	59900	93	361	2015
HTP-100-4T-30 IE3	1470		41.00	23.80	22.00	69900	96	361	2015
HTP-100-4T-40 IE3	1480		57.10	33.10	30.00	80500	98	429	2015
HTP-125-4T-40 IE3	1480		57.10	33.10	30.00	81000	100	531	2015
HTP-125-4T-50 IE3	1480		69.20	40.10	37.00	96800	100	602	2015
HTP-125-4T-60 IE3	1475		80.90	46.90	45.00	105050	100	658	2015
HTP-125-4T-75 IE3	1480		98.60	57.20	55.00	127800	100	664	2015
HTP-125-4T-100 IE3	1485		134.00	77.70	75.00	147350	104	784	2015
HTP-125-4T-125 IE3	1485		158.00	91.60	90.00	156800	105	823	2015



Erp. (Energy Related Products)

Information on Directive 2009/125/EC can be downloaded from the SODECA website or the QuickFan selector programme.

Acoustic characteristics

The indicated values are determined by measuring the sound pressure and power levels in dB(A), obtained in a free field at a distance equivalent to twice the size of the fan plus the diameter of the impeller, with a minimum of 1.5 m

Sound power spectrum Lw(A) in dB(A) per Hz frequency band

Model	LpdB(A)	63	125	250	500	1000	2000	4000	8000	Model	LpdB(A)	63	125	250	500	1000	2000	4000	8000
HTP-50-2T-4	80	57	77	85	90	92	89	82	71	HTP-80-4T-4	86	58	75	86	95	96	96	93	86
HTP-50-2T-5.5	81	58	78	86	91	93	90	83	72	HTP-80-4T-5.5	86	58	76	86	95	96	96	93	86
HTP-56-2T-5.5	86	63	83	91	96	98	95	88	77	HTP-80-4T-7.5	86	58	76	86	95	96	96	93	86
HTP-56-2T-10	87	64	84	92	97	99	96	89	78	HTP-80-4T-10	87	59	77	87	97	98	98	94	88
HTP-63-2T-10	94	70	82	92	104	105	104	99	91	HTP-80-4T-15	91	63	81	91	101	102	102	99	92
HTP-63-2T-15	94	70	82	92	104	105	104	99	91	HTP-90-4T-7.5	90	62	79	90	99	100	100	97	90
HTP-63-2T-20	97	73	85	95	107	108	107	102	94	HTP-90-4T-10	90	62	80	90	99	100	100	97	90
HTP-63-2T-25	98	74	86	96	108	109	108	103	95	HTP-90-4T-15	90	62	80	90	100	101	101	98	91
HTP-63-2T-30	99	75	87	97	109	110	109	104	96	HTP-90-4T-20	94	66	83	94	103	104	104	101	94
HTP-63-4T-1.5	79	55	67	77	89	90	89	84	76	HTP-90-4T-25	95	67	85	95	104	105	105	102	95
HTP-63-4T-2	79	55	67	77	89	90	89	84	76	HTP-90-4T-30	97	69	87	97	107	108	108	104	98
HTP-63-4T-3	83	59	71	81	93	94	93	88	80	HTP-100-4T-15	93	65	83	93	102	103	103	100	93
HTP-63-4T-4	84	60	72	82	94	95	94	89	81	HTP-100-4T-20	93	65	82	93	102	103	103	100	93
HTP-71-2T-15	93	65	83	93	102	104	103	100	93	HTP-100-4T-25	93	65	83	93	102	103	103	100	93
HTP-71-2T-20	95	67	85	95	104	106	105	102	95	HTP-100-4T-30	96	67	85	96	105	106	106	103	96
HTP-71-2T-25	95	67	85	95	104	106	105	102	95	HTP-100-4T-40	98	70	88	98	107	108	108	105	98
HTP-71-2T-30	95	67	85	95	104	106	105	102	95	HTP-125-4T-40	100	72	89	100	109	110	110	107	100
HTP-71-2T-40	98	70	88	98	107	109	108	105	98	HTP-125-4T-50	100	72	90	100	109	110	110	107	100
HTP-71-4T-2	83	55	73	83	92	93	93	90	83	HTP-125-4T-60	100	72	89	100	109	110	110	107	100
HTP-71-4T-3	83	55	72	83	92	93	93	90	83	HTP-125-4T-75	100	72	90	100	110	111	111	108	101
HTP-71-4T-4	84	56	74	84	94	95	95	91	85	HTP-125-4T-100	104	76	93	104	113	114	114	111	104
HTP-71-4T-5.5	87	59	77	87	97	98	98	95	88	HTP-125-4T-125	105	77	95	105	114	115	115	112	105
HTP-71-4T-7.5	90	62	80	90	100	101	101	97	91										

Dimensions mm

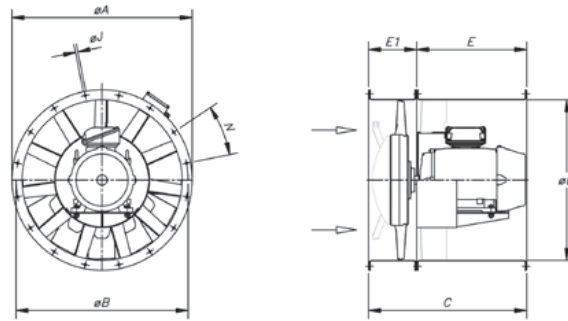

Model	Power	$\varnothing A$	$\varnothing B$	$\varnothing D$	E	E1	C	$\varnothing J$	N
HTP-50-2T	4/5.5	600	560	514	-	-	400	12	12x30°
HTP-56-2T	5.5/10	660	620	560	-	-	500	12	12x30°
HTP-63-2T	10/15/20/25/30	730	690	640	650	220	870	13	12x30°
HTP-63-4T	1.5/2/3/4	730	690	640	340	220	560	13	12x30°
HTP-71-2T	15/20/25/30/40	810	770	710	700	240	940	13	16x22°30'
HTP-71-4T	2/3/4/5.5/7.5	810	770	710	420	240	660	13	16x22°30'
HTP-80-4T	4 / 5.5	900	860	800	360	240	600	15	16x22°30'
HTP-80-4T	7.5 / 10 / 15	900	860	800	600	240	840	15	16x22°30'
HTP-90-4T	7.5 / 10	1015	970	900	420	250	670	15	16x22°30'
HTP-90-4T	15 / 20 / 25 / 30	1015	970	900	650	250	900	15	16x22°30'
HTP-100-4T	15 / 20	1115	1070	1000	600	270	870	15	16x22°30'
HTP-100-4T	25 / 30 / 40	1115	1070	1000	700	270	970	15	16x22°30'
HTP-125	40 / 50 / 60 / 75	1365	1320	1250	900	300	1100	15	20x18°
HTP-125	100 / 125	1365	1320	1250	950	300	1250	15	20x18°

Accessories

See accessories section.



SELECTION EXAMPLE

Characteristic curves

Q= Flow rate in m³/h, m³/s and cfm.

Pe= Static pressure in mm H₂O, Pa and inwg.

HTP-63-4T

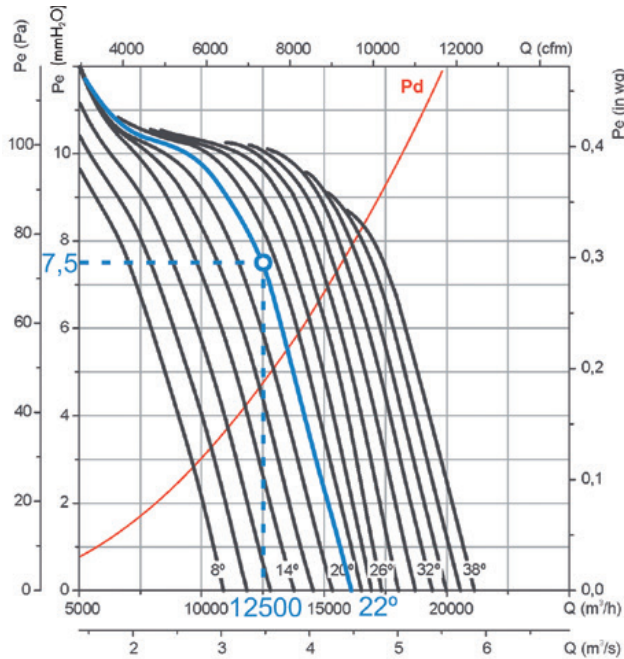

Starting data

- Working point:
- Flow rate: 12,500 m³/h
- Load loss: 7.5 mm H₂O

Equipment selection steps

On the pressure graph:

1. Mark the working point defined by the flow rate (12,500 m³/h) and the load loss (7.5 mm H₂O).
2. Select the nearest equipment curve above the working point. In this case, a blade angle curve of 22° is obtained.

On the power graph:

3. Mark the working point defined by the working flow rate (12,500 m³/h) and the selected blade angle curve (22°).
4. Read the absorbed power on the left power axis. Pa= 560 W at the working point.
5. Find the nearest straight red line above the working point. The installed motor power is given on the right side of the graph. In this case, 0.75 kW or 1 HP

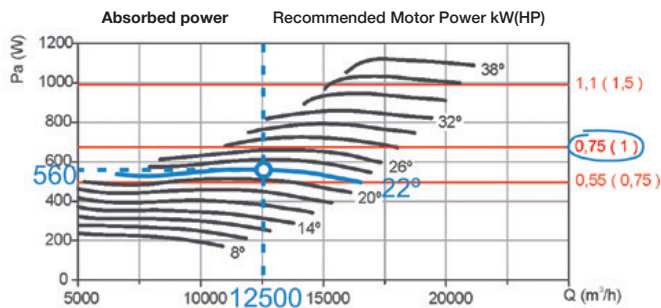

ORDER CODE EXAMPLE

HTP — 63 — 4T — 1 — 22°

HTP
Tubular, high pressure,
axial extract fans

63
Impeller
diameter
in cm

4T
Number of motor poles
4=1400 r/min. 50 Hz
6=900 r/min. 50 Hz
8=750 r/min. 50 Hz

T= Three-phase
M= Single-phase

1
Motor power
(HP)

22°
Blades
inclination angle

Characteristic curves

Q= Flow rate in m³/h, m³/s and cfm.

Pe= Static pressure in mm H₂O, Pa and inwg.

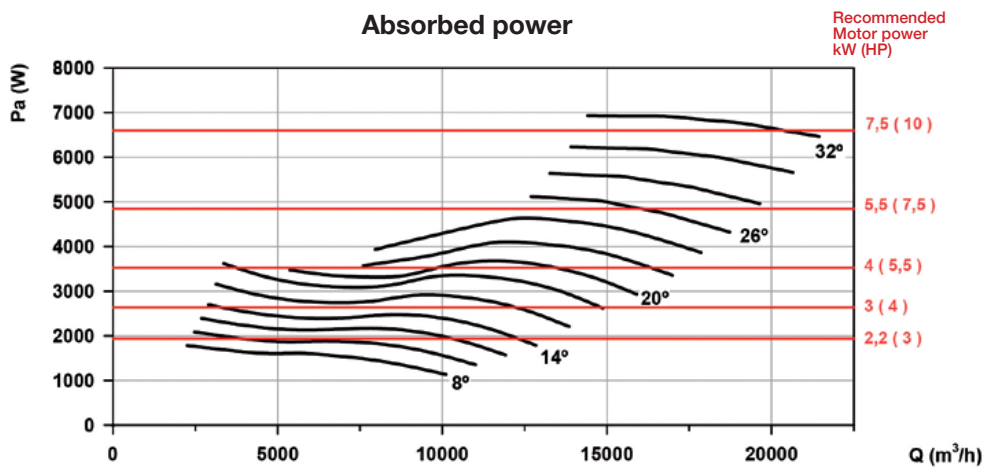
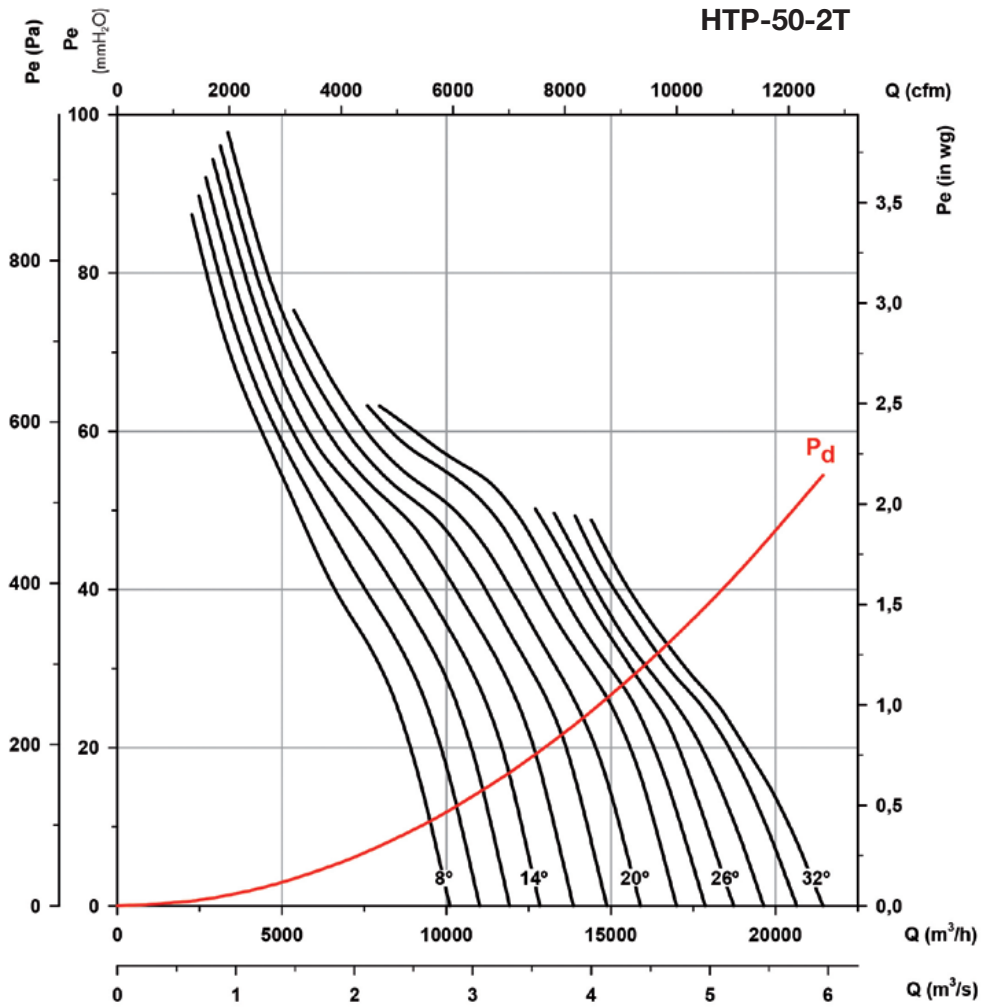

Characteristic curves

Q= Flow rate in m³/h, m³/s and cfm.

Pe= Static pressure in mm H₂O, Pa and inwg.

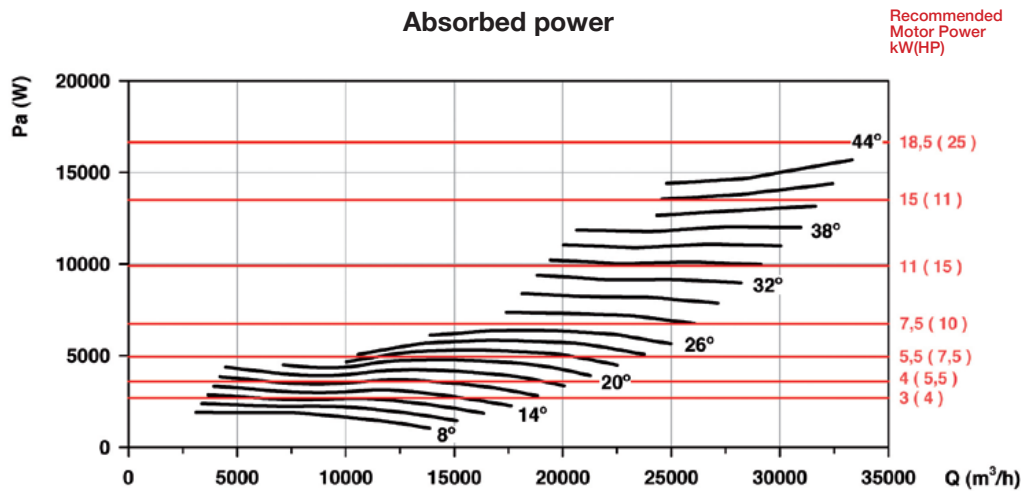
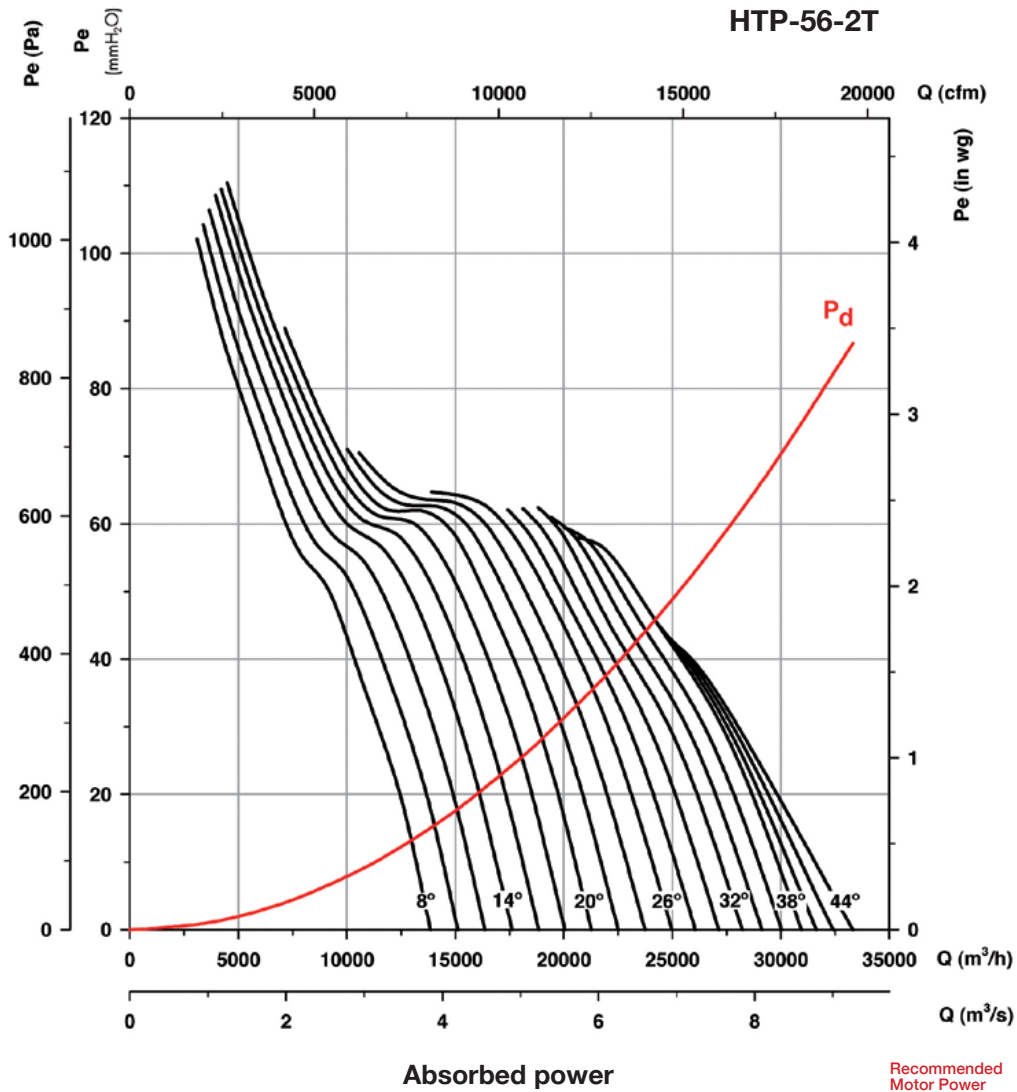

Characteristic curves

Q= Flow rate in m³/h, m³/s and cfm.

Pe= Static pressure in mm H₂O, Pa and inwg.

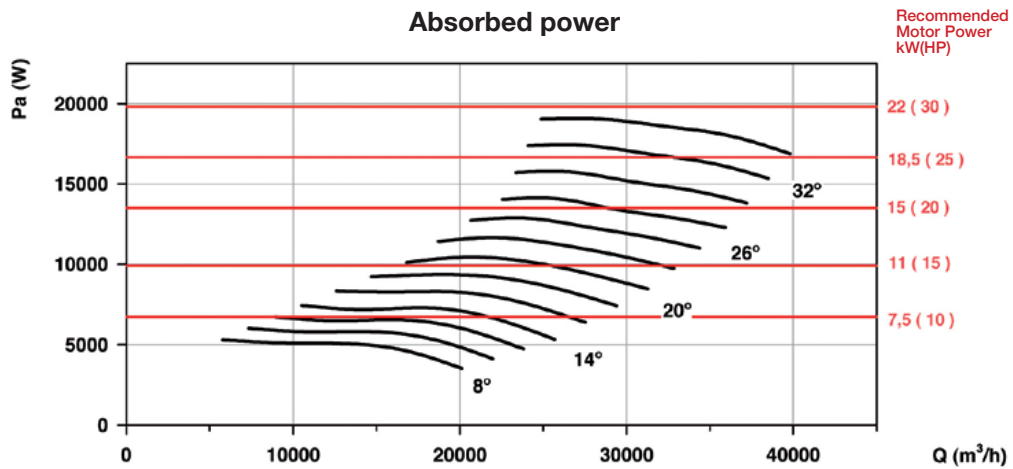
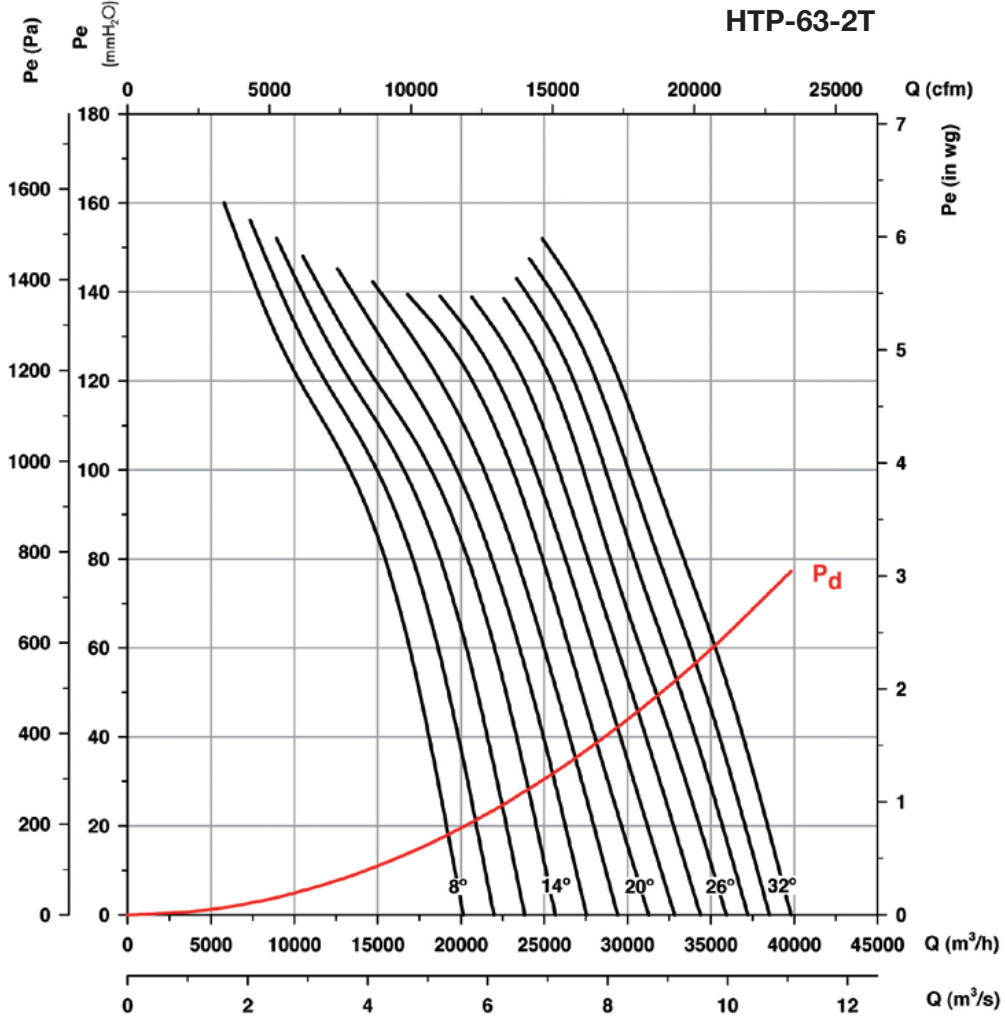

Characteristic curves

Q= Flow rate in m³/h, m³/s and cfm.

Pe= Static pressure in mm H₂O, Pa and inwg.

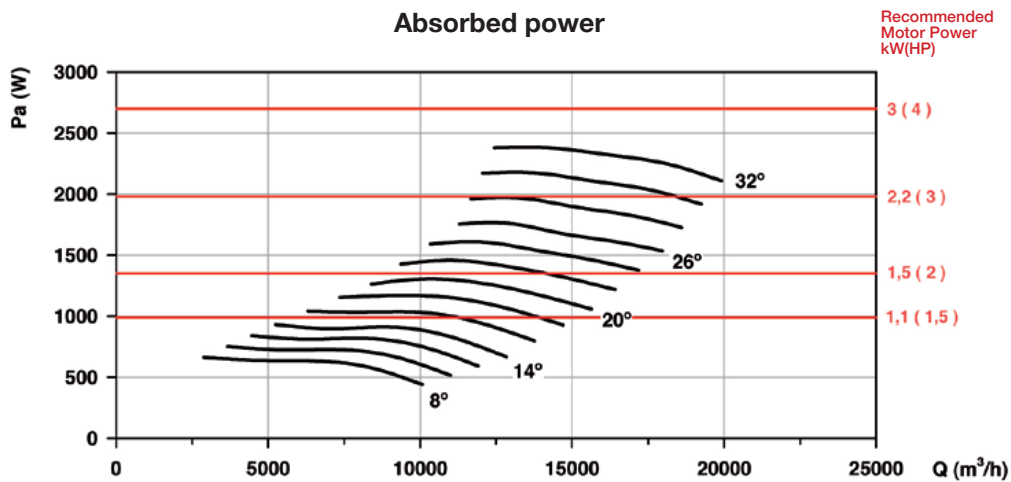
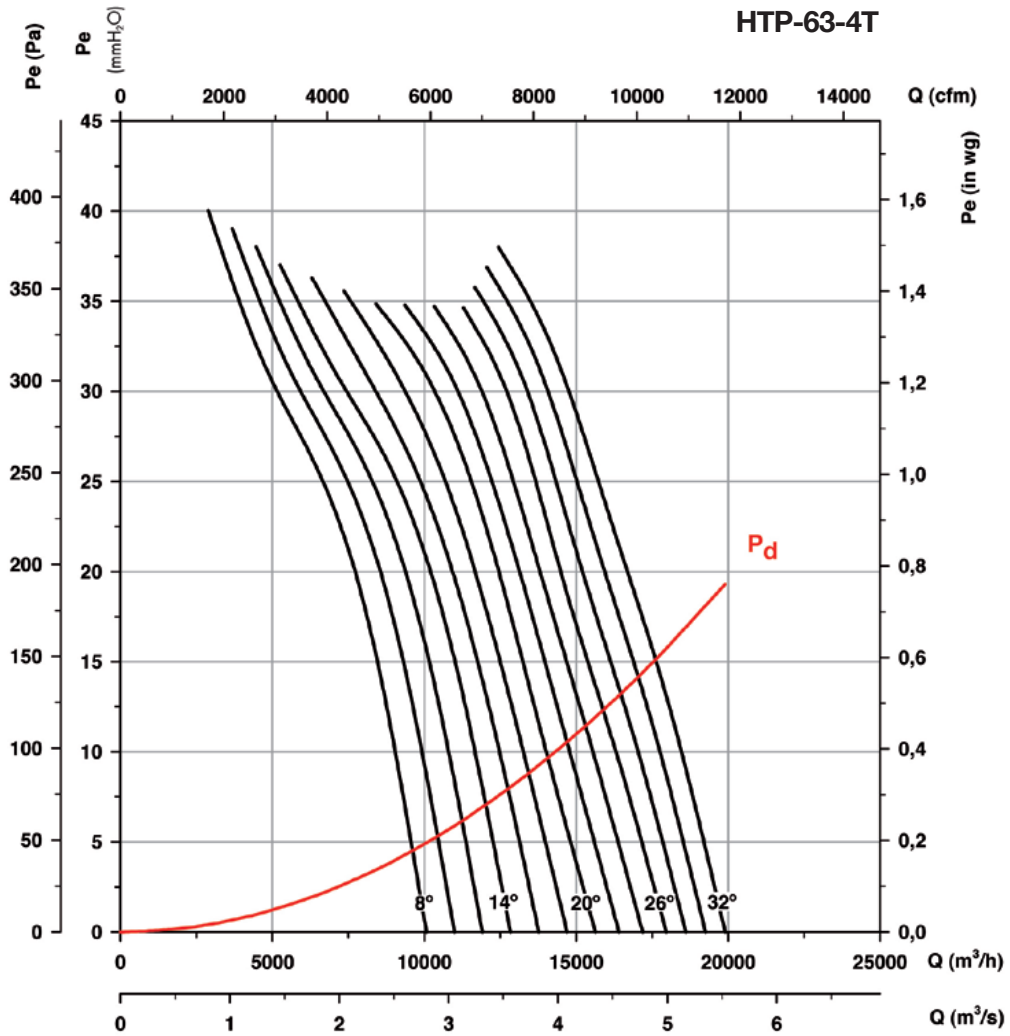

Characteristic curves

Q= Flow rate in m³/h, m³/s and cfm.

Pe= Static pressure in mm H₂O, Pa and inwg.

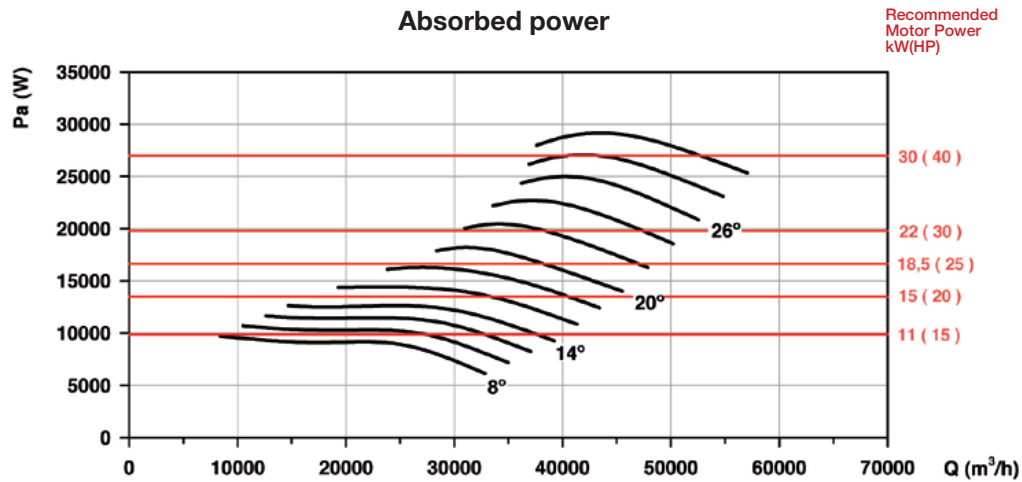
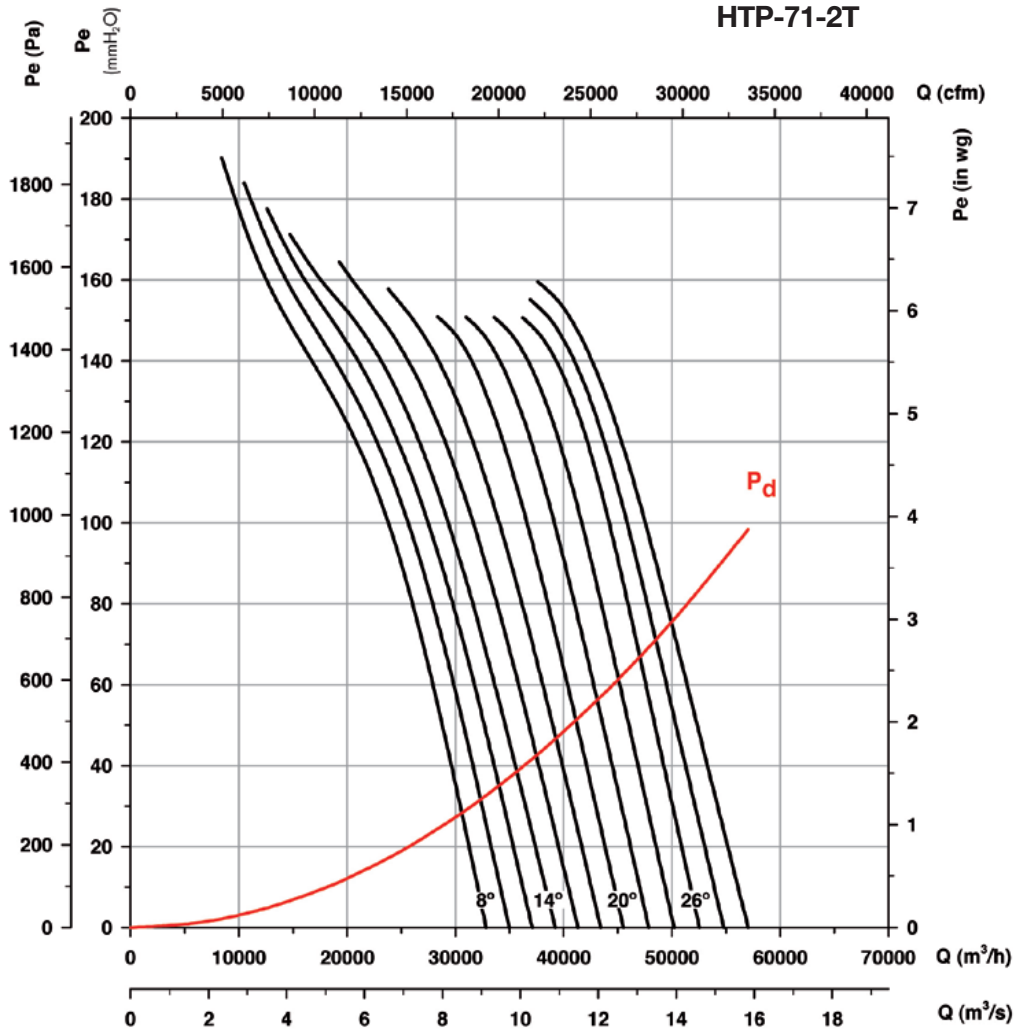

Characteristic curves

Q= Flow rate in m³/h, m³/s and cfm.

Pe= Static pressure in mm H₂O, Pa and inwg.

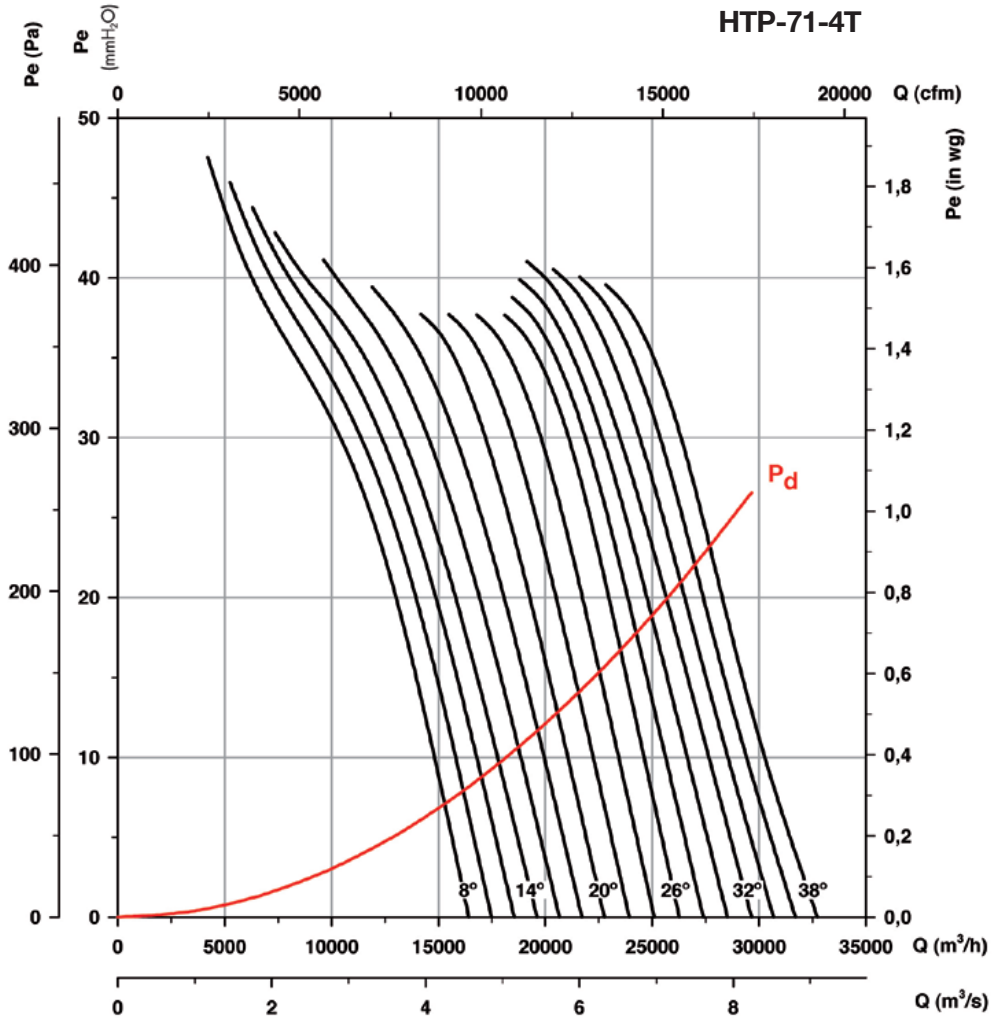

Absorbed power

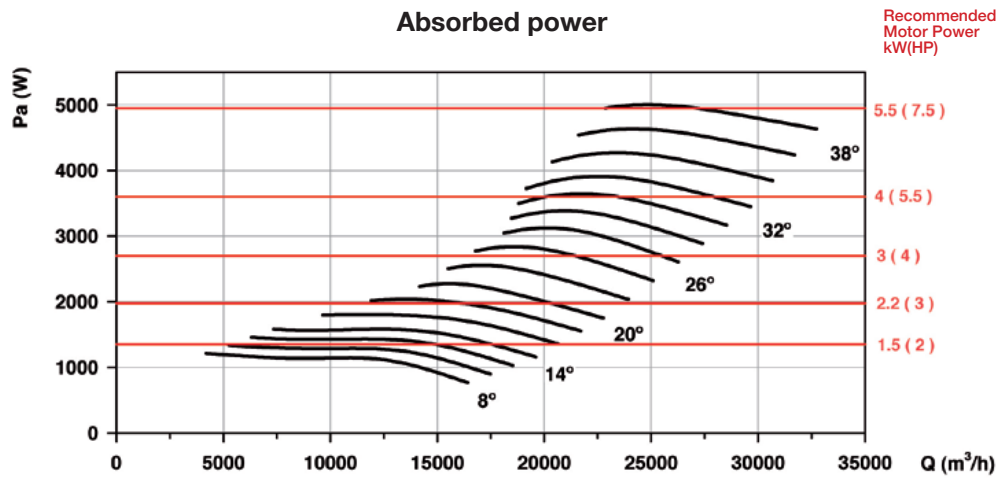

Characteristic curves

Q= Flow rate in m³/h, m³/s and cfm.

Pe= Static pressure in mm H₂O, Pa and inwg.

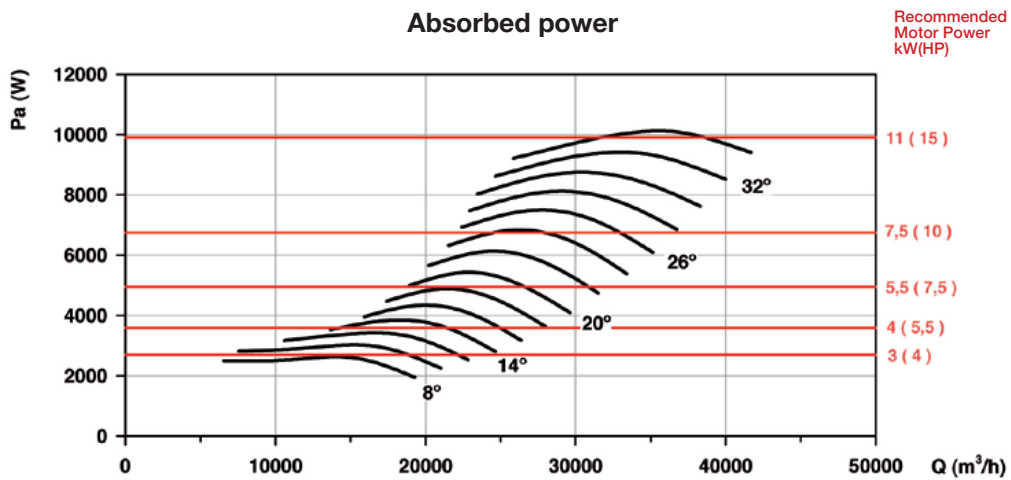
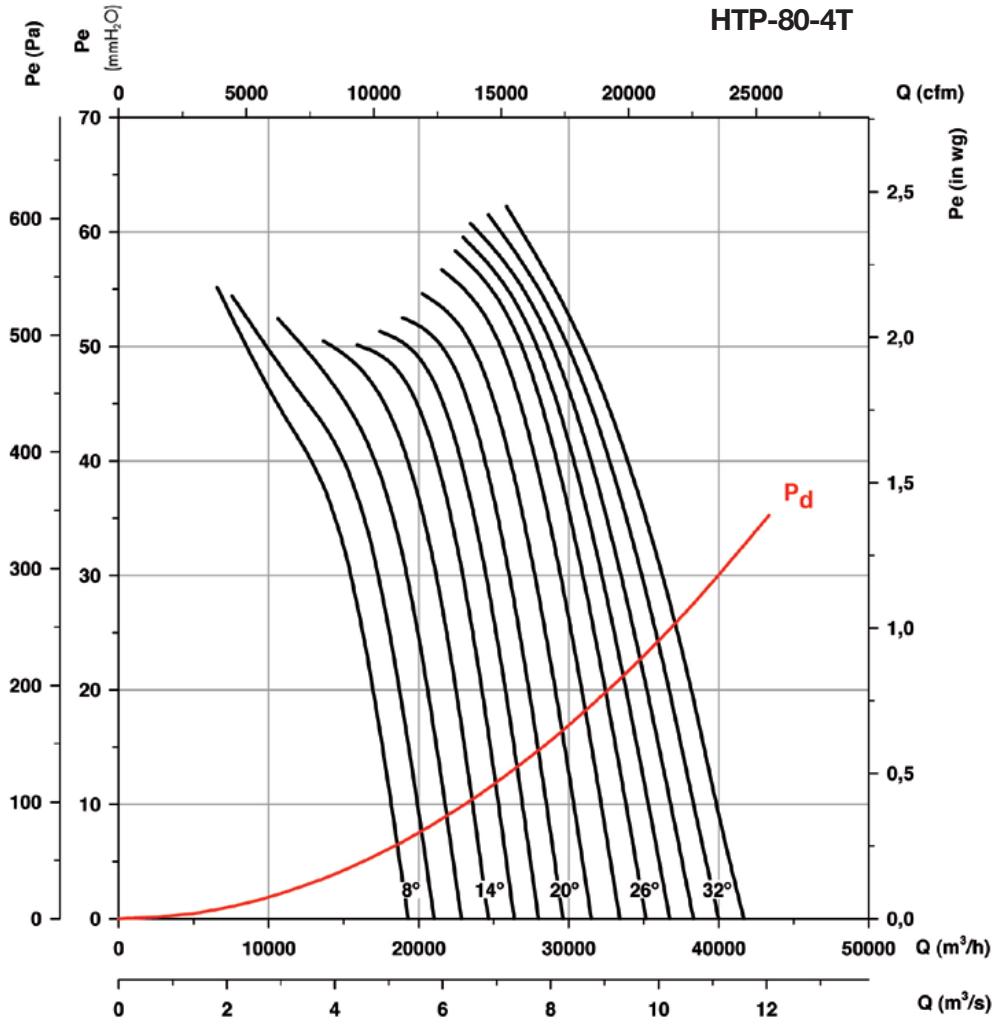

Characteristic curves

Q= Flow rate in m³/h, m³/s and cfm.

Pe= Static pressure in mm H₂O, Pa and inwg.

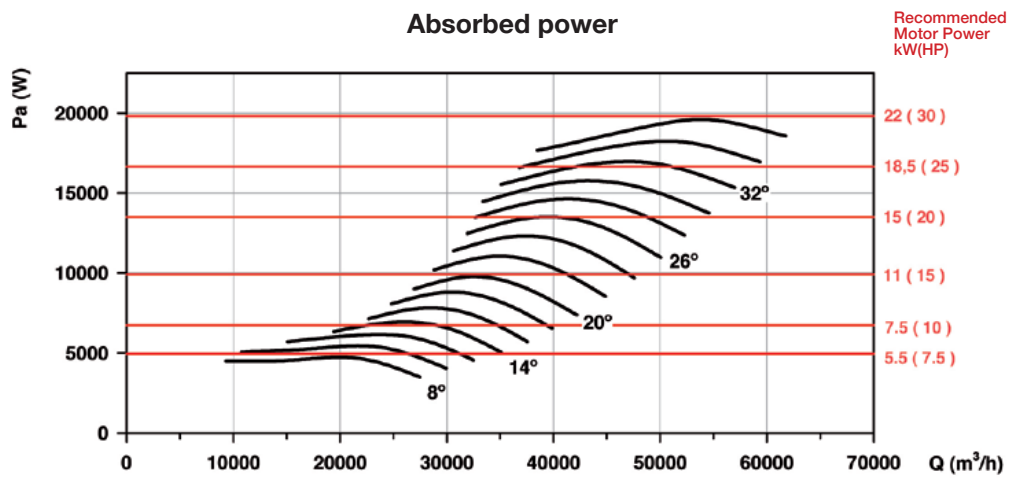
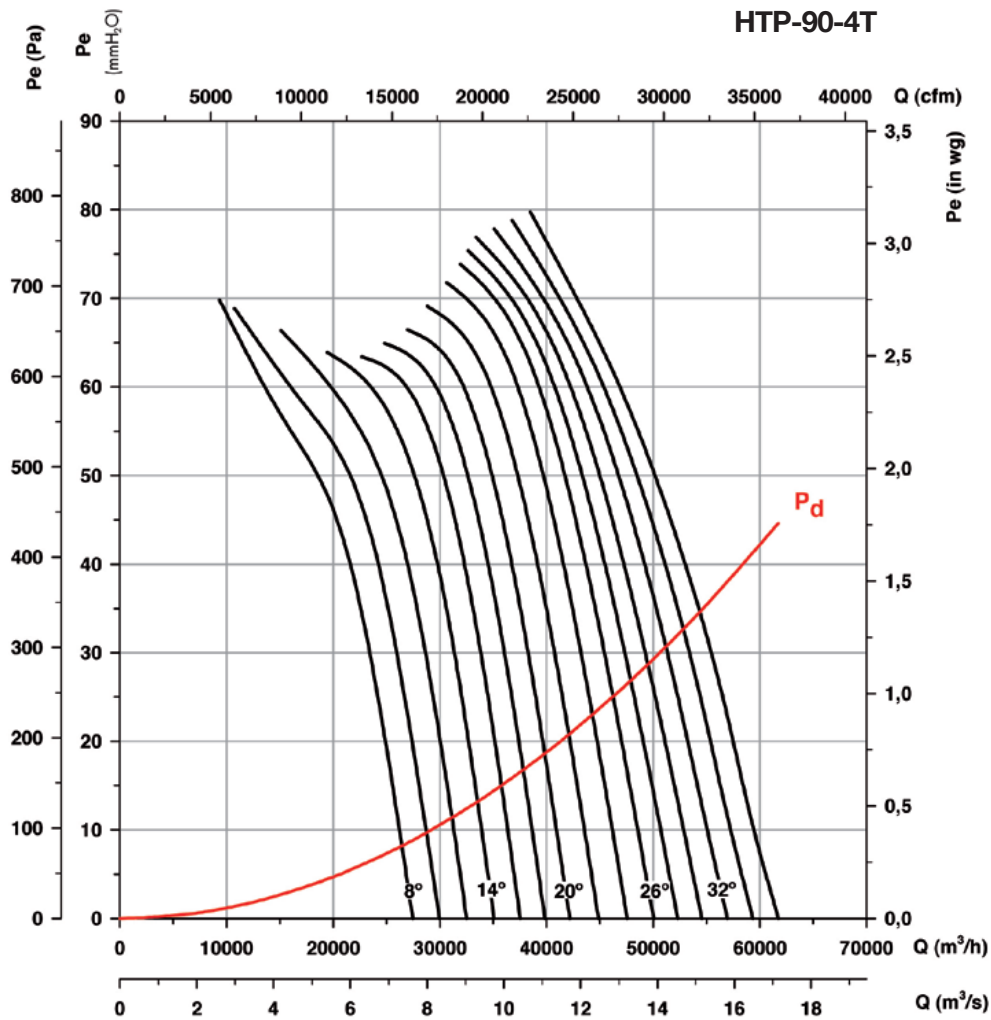

Characteristic curves

Q= Flow rate in m³/h, m³/s and cfm.

Pe= Static pressure in mm H₂O, Pa and inwg.

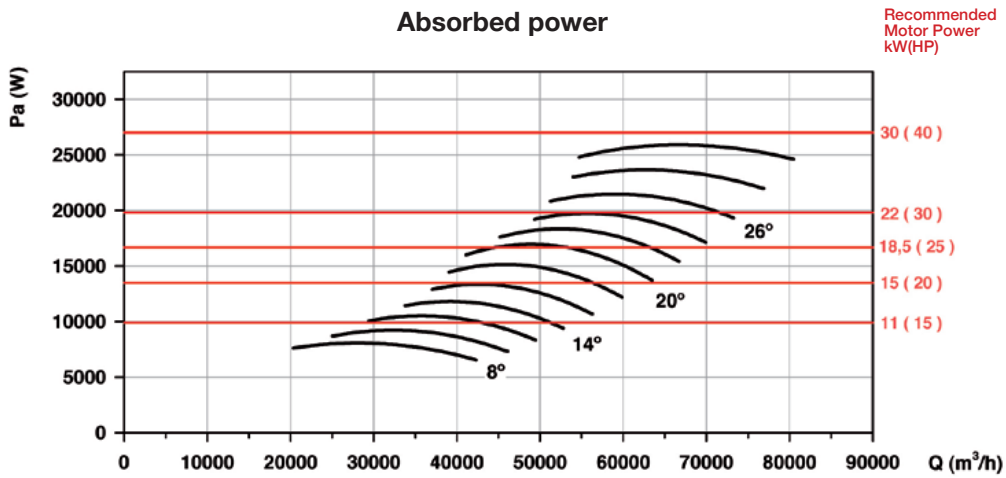
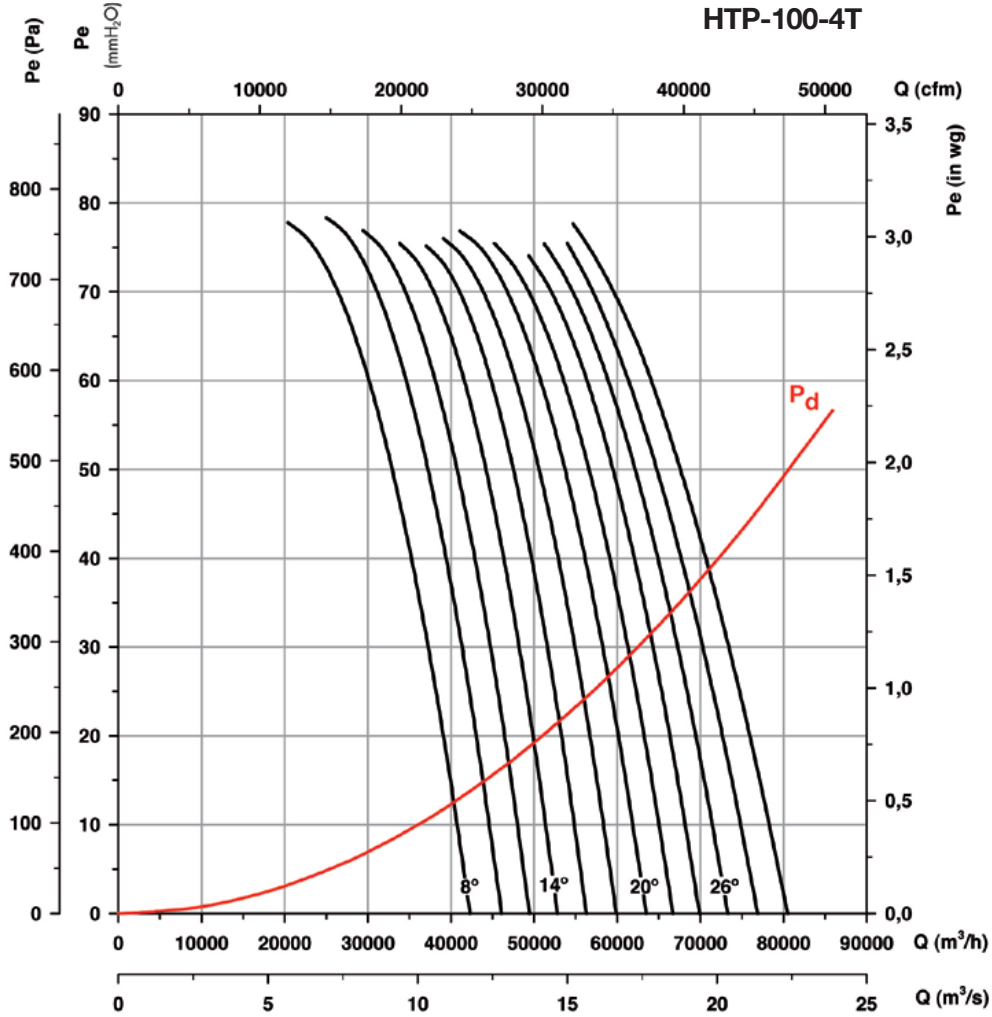

Characteristic curves

Q= Flow rate in m³/h, m³/s and cfm.

Pe= Static pressure in mm H₂O, Pa and inwg.

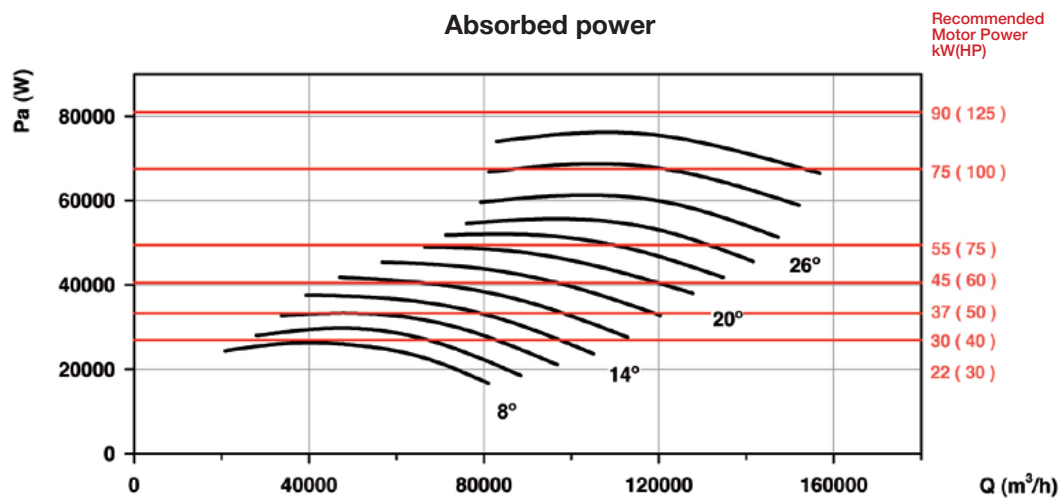
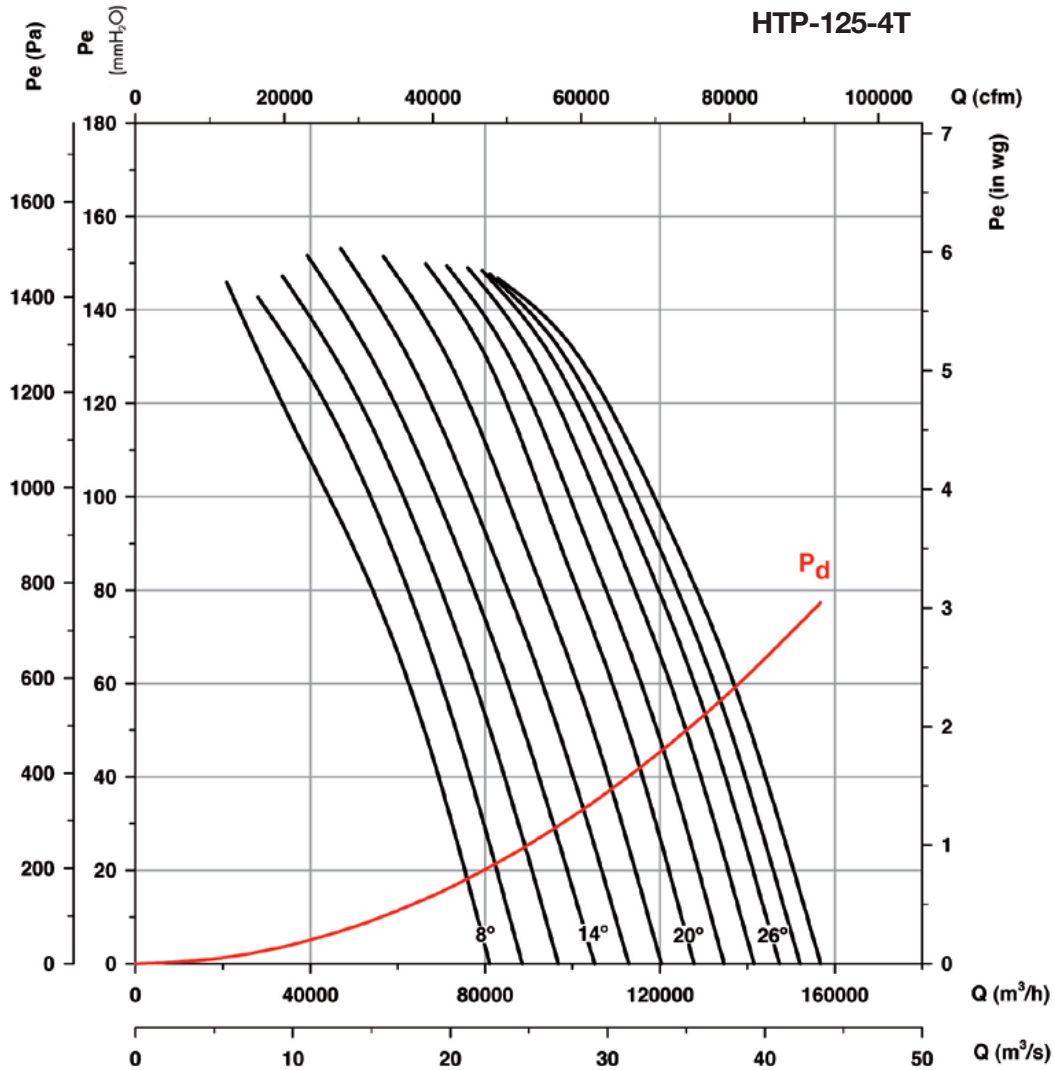

HGT HGTX



HGT: Large diameter tubular axial fans with direct drive motors

HGTX: Large diameter tubular axial fans with external motors



Tubular axial fans fitted with aluminium impellers with 6 or 9 blades and different angles of inclination.

Fan:

- Airflow direction from motor to impeller.
- Impellers made of cast aluminium with 6 or 9 blades with adjustable angle of inclination.
- Tubular sheet steel casing.
- HGT: The standard version has a short casing. The long cased version is fitted with an inspection hatch.
- HGTX: Standard long cased version fitted with an inspection hatch.

Motor:

- IE3 efficiency motors for powers equal to or higher than 0.75kW except single-phase, 2-speed and 8-pole.
- Class F motors with ball bearings and IP55 protection.

- Three-phase 230/400V-50Hz (up to 4kW) and 400/690V-50Hz (powers higher than 4kW).
- Operating temperature:
HGT: -25°C +50°C
HGTX: -25 °C +120 °C

Finish:

- Anti-corrosive finish of polyester resin polymerised at 190 °C, previously degreased with phosphate-free nanotechnological treatment.

On request:

- Airflow direction from impeller to motor.
- 100% reversible impellers.
- Special windings for different voltages.
- ATEX-certified Category 2.
- HGT: Long cased fans fitted with an inspection hatch.
- Two-speed motors.

Order code



HGT: Tubular axial fans with large diameters and direct drive motors.
HGTX: Large diameter tubular axial fans with external motor.

Impeller diameter in cm

Number of motor poles
4=1400 r/min. 50 Hz
6=900 r/min. 50 Hz
8=750 r/min. 50 Hz

T= Three-phase

Number of blades
6 blades
9 blades

Motor power (HP)

Blade inclination angle

PV=Inlet housing



Technical characteristics

Model		Speed	Maximum admissible current (A)			Installed power	Maximum flow rate	Sound pressure level	Approx. weight (kg)			According to ErP
HGT	HGTX	(r/min)	230V	400V	690V	(kW)	(m³/h)	dB(A)	HGT Long	HGT Short	HGTX	
HGT	HGTX	125-4T/6-20 IE3	1465	27.90	16.20	15.00	78300	89	294	266	414	2015
HGT	HGTX	125-4T/6-25 IE3	1470	35.10	20.30	18.50	92000	90	372	329	459	2015
HGT	HGTX	125-4T/6-30 IE3	1470	41.00	23.80	22.00	98100	90	372	329	459	2015
HGT	HGTX	125-4T/6-40 IE3	1480	57.10	33.10	30.00	117000	92	477	433	566	2015
HGT	HGTX	125-4T/6-50 IE3	1480	69.20	40.10	37.00	123700	93	560	504	631	2015
HGT	HGTX	125-4T/6-60 IE3	1475	80.90	46.90	45.00	136000	94	598	542	669	2015
HGT	HGTX	125-4T/6-75 IE3	1480	98.60	57.20	55.00	148000	95	614	564	700	2015
HGT	HGTX	125-4T/6-100 IE3	1485	134.00	77.70	75.00	161000	96	708	658	794	2015
HGT	HGTX	125-4T/9-25 IE3	1470	35.10	20.30	18.50	79750	88	381	338	468	2015
HGT	HGTX	125-4T/9-30 IE3	1470	41.00	23.80	22.00	97000	89	381	338	468	2015
HGT	HGTX	125-4T/9-40 IE3	1480	57.10	33.10	30.00	111200	91	486	442	575	2015
HGT	HGTX	125-4T/9-50 IE3	1480	69.20	40.10	37.00	118350	93	569	513	640	2015
HGT	HGTX	125-4T/9-60 IE3	1475	80.90	46.90	45.00	127000	94	607	551	678	2015
HGT	HGTX	125-4T/9-75 IE3	1480	98.60	57.20	55.00	142000	95	623	573	709	2015
HGT	HGTX	125-4T/9-100 IE3	1485	134.00	77.70	75.00	155000	99	717	667	803	2015
HGT	HGTX	125-6T/6-5.5 IE3	960	15.60	8.99	4.00	51300	77	216	183	347	2015
HGT	HGTX	125-6T/6-7.5 IE3	970	11.20	6.49	5.50	60300	77	228	195	359	2015

Technical characteristics

Model			Speed (r/min)	Maximum admissible current (A)			Installed power (kW)	Maximum flow rate (m³/h)	Sound pressure level dB(A)	Approx. weight (kg)			According to ErP
				230V	400V	690V				HGT Long	HGT Short	HGTX	
HGT	HGTX	125-6T/6-10 IE3	975		14.80	8.58	7.50	72250	79	306	278	426	2015
HGT	HGTX	125-6T/6-15 IE3	975		21.90	12.70	11.00	85450	81	307	279	427	2015
HGT	HGTX	125-6T/6-20 IE3	975		28.20	16.30	15.00	92850	82	416	373	503	2015
HGT	HGTX	125-6T/6-25 IE3	980		35.90	20.80	18.50	103000	84	449	405	538	2015
HGT	HGTX	125-6T/9-10 IE3	975		14.80	8.58	7.50	68200	78	315	287	435	2015
HGT	HGTX	125-6T/9-15 IE3	975		21.90	12.70	11.00	77550	81	316	288	436	2015
HGT	HGTX	125-6T/9-20 IE3	975		28.20	16.30	15.00	92900	84	425	382	512	2015
HGT	HGTX	125-6T/9-25 IE3	980		35.90	20.80	18.50	98700	85	458	414	547	2015
HGT	HGTX	125-6T/9-30 IE3	980		42.40	24.60	22.00	104000	87	463	419	552	2015
HGT	HGTX	125-8T/6-3	705	9.53	5.50		2.20	45700	69	218	185	349	2015
HGT	HGTX	125-8T/6-4	705	12.82	7.40		3.00	51800	71	225	192	356	2015
HGT	HGTX	125-8T/6-5.5	710	16.11	9.30		4.00	61500	72	258	230	378	2015
HGT	HGTX	125-8T/6-7.5	710		12.00	7.20	5.50	67500	73	271	243	391	2015
HGT	HGTX	125-8T/6-10	725		16.00	9.50	7.50	75500	75	301	273	421	2015
HGT	HGTX	125-8T/9-4	705	12.82	7.40		3.00	48200	70	234	201	365	2015
HGT	HGTX	125-8T/9-5.5	710	16.11	9.30		4.00	55200	73	267	239	387	2015
HGT	HGTX	125-8T/9-7.5	710		12.00	7.20	5.50	67000	75	280	252	400	2015
HGT	HGTX	125-8T/9-10	725		16.00	9.50	7.50	74750	76	310	282	430	2015
HGT	HGTX	125-8T/9-15	720		24.00	13.80	11.00	80800	79	372	329	459	2015
HGT	-	140-6T/6-5.5 IE3	960	15.60	8.99		4.00	58000	82	266	229		2015
HGT	-	140-6T/6-7.5 IE3	970		11.20	6.49	5.50	66000	84	278	241		2015
HGT	-	140-6T/6-10 IE3	975		14.80	8.58	7.50	80700	85	365	326		2015
HGT	-	140-6T/6-15 IE3	975		21.90	12.70	11.00	96700	86	366	327		2015
HGT	-	140-6T/6-20 IE3	975		28.20	16.30	15.00	104000	87	472	423		2015
HGT	-	140-6T/6-25 IE3	980		35.90	20.80	18.50	115000	88	506	457		2015
HGT	-	140-6T/6-30 IE3	980		42.40	24.60	22.00	119000	89	511	462		2015
HGT	-	140-6T/9-10 IE3	975		14.80	8.58	7.50	70000	84	374	335		2015
HGT	-	140-6T/9-15 IE3	975		21.90	12.70	11.00	86000	86	375	336		2015
HGT	-	140-6T/9-20 IE3	975		28.20	16.30	15.00	97500	87	482	432		2015
HGT	-	140-6T/9-25 IE3	980		35.90	20.80	18.50	111000	88	515	467		2015
HGT	-	140-6T/9-30 IE3	980		42.40	24.60	22.00	118500	89	520	472		2015
HGT	-	140-6T/9-40 IE3	985		55.40	32.10	30.00	132000	91	676	614		2015
HGT	-	140-6T/9-50 IE3	985		67.20	39.00	37.00	139000	92	693	638		2015
HGT	-	140-8T/6-3	705	9.53	5.50		2.20	47500	78	268	231		2015
HGT	-	140-8T/6-4	705	12.82	7.40		3.00	57600	79	275	238		2015
HGT	-	140-8T/6-5.5	710	16.11	9.30		4.00	65200	80	317	278		2015
HGT	-	140-8T/6-7.5	710		12.00	7.20	5.50	73300	81	330	291		2015
HGT	-	140-8T/6-10	725		16.00	9.50	7.50	82200	82	360	321		2015
HGT	-	140-8T/6-15	720		24.00	13.80	11.00	94200	83	419	370		2015
HGT	-	140-8T/9-4	705	12.82	7.40		3.00	47200	79	284	247		2015
HGT	-	140-8T/9-5.5	710	16.11	9.30		4.00	64400	79	326	287		2015
HGT	-	140-8T/9-7.5	710		12.00	7.20	5.50	69200	81	339	300		2015
HGT	-	140-8T/9-10	725		16.00	9.50	7.50	78700	82	369	330		2015
HGT	-	140-8T/9-15	720		24.00	13.80	11.00	94300	83	429	379		2015
HGT	-	140-8T/9-20	725		31.00	18.10	15.00	103000	86	485	437		2015
HGT	-	160-6T/6-10 IE3	975		14.80	8.58	7.50	75000	83	439	385		2015
HGT	-	160-6T/6-15 IE3	975		21.90	12.70	11.00	93500	85	440	386		2015
HGT	-	160-6T/6-20 IE3	975		28.20	16.30	15.00	120500	86	559	490		2015
HGT	-	160-6T/6-25 IE3	980		35.90	20.80	18.50	130000	87	593	524		2015
HGT	-	160-6T/6-30 IE3	980		42.40	24.60	22.00	140000	88	598	529		2015
HGT	-	160-6T/6-40 IE3	985		55.40	32.10	30.00	158000	89	771	672		2015
HGT	-	160-6T/6-50 IE3	985		67.20	39.00	37.00	171000	91	784	699		2015
HGT	-	160-6T/9-15 IE3	975		21.90	12.70	11.00	87000	85	450	396		2015
HGT	-	160-6T/9-20 IE3	975		28.20	16.30	15.00	104000	86	569	500		2015
HGT	-	160-6T/9-25 IE3	980		35.90	20.80	18.50	127000	87	603	534		2015
HGT	-	160-6T/9-30 IE3	980		42.40	24.60	22.00	135000	88	608	539		2015
HGT	-	160-6T/9-40 IE3	985		55.40	32.10	30.00	147000	89	781	682		2015
HGT	-	160-6T/9-50 IE3	985		67.20	39.00	37.00	165000	90	794	710		2015
HGT	-	160-6T/9-60 IE3	985		84.40	48.90	45.00	177000	91	1019	920		2015
HGT	-	160-6T/9-75 IE3	985		103.00	59.70	55.00	193000	92	1077	978		2015
HGT	-	160-6T/9-100 IE3	990		139.00	80.60	75.00	207500	93	1232	1133		2015
HGT	-	160-8T/6-4	705	12.82	7.40		3.00	70900	76	344	292		2015
HGT	-	160-8T/6-5.5	710	16.11	9.30		4.00	84500	77	391	337		2015
HGT	-	160-8T/6-7.5	710		12.00	7.20	5.50	77000	79	404	350		2015
HGT	-	160-8T/6-10	725		16.00	9.50	7.50	95000	80	434	380		2015
HGT	-	160-8T/6-15	720		24.00	13.80	11.00	109000	82	506	437		2015

Technical characteristics

Model	Speed (r/min)	Maximum admissible current (A)			Installed power (kW)	Maximum flow rate (m³/h)	Sound pressure level dB(A)	Approx. weight (kg)			According to ErP
		230V	400V	690V				HGT Long	HGT Short	HGTX	
HGT - 160-8T/6-20	725		31.00	18.10	15.00	123000	83	563	494		2015
HGT - 160-8T/6-25	725		36.00	20.70	18.50	130000	84	641	542		2015
HGT - 160-8T/9-7.5	710		12.00	7.20	5.50	70000	79	414	360		2015
HGT - 160-8T/9-10	725		16.00	9.50	7.50	87000	80	444	390		2015
HGT - 160-8T/9-15	720		24.00	13.80	11.00	103000	82	516	447		2015
HGT - 160-8T/9-20	725		31.00	18.10	15.00	117000	83	573	504		2015
HGT - 160-8T/9-25	725		36.00	20.70	18.50	133000	84	651	552		2015
HGT - 160-8T/9-30	725		42.00	24.40	22.00	140000	85	666	567		2015
HGT - 160-8T/9-40	730		61.00	35.10	30.00	151000	86	724	640		2015



Erp. (Energy Related Products)

Information on Directive 2009/125/EC can be downloaded from the SODECA website or the QuickFan selector programme.

Acoustic characteristics

The indicated values are determined by measuring the sound pressure level and sound power in dB(A) obtained in a free field at a distance equivalent to twice the size of the fan plus the impeller diameter, with a minimum of 1.5 m.

Sound power spectrum Lw(A) in dB(A) per Hz frequency band

Model	63	125	250	500	1000	2000	4000	8000	Model	63	125	250	500	1000	2000	4000	8000
125-4T/6-20	66	74	90	97	99	94	88	84	140-6T/9-25	70	88	97	96	95	91	82	77
125-4T/6-25	67	75	91	98	100	95	89	85	140-6T/9-30	70	88	97	96	95	91	82	77
125-4T/6-30	68	76	92	99	101	96	90	86	140-6T/9-40	71	89	98	97	96	92	83	78
125-4T/6-40	69	77	93	100	102	97	91	87	140-6T/9-50	74	92	101	100	99	95	86	81
125-4T/6-50	71	79	95	102	104	99	93	89	140-8T/6-3	61	73	82	86	84	78	68	65
125-4T/6-60	72	80	96	103	105	100	94	90	140-8T/6-4	63	75	84	88	86	80	70	67
125-4T/6-75	72	80	96	103	105	100	94	90	140-8T/6-5.5	64	76	85	89	87	81	71	68
125-4T/6-100	74	82	98	105	107	102	96	92	140-8T/6-7.5	65	77	86	90	88	82	72	69
125-4T/9-25	66	74	91	97	98	93	88	84	140-8T/6-10	66	78	87	91	89	83	73	70
125-4T/9-30	67	75	92	98	99	94	89	85	140-8T/6-15	68	80	89	93	91	85	75	72
125-4T/9-40	68	76	93	99	100	95	90	86	140-8T/9-4	61	72	83	88	86	82	72	67
125-4T/9-50	70	78	95	101	102	97	92	88	140-8T/9-5.5	62	73	84	89	87	83	73	68
125-4T/9-60	72	80	97	103	104	99	94	90	140-8T/9-7.5	63	74	85	90	88	84	74	69
125-4T/9-75	72	80	97	103	104	99	94	90	140-8T/9-10	64	75	86	91	89	85	75	70
125-4T/9-100	74	82	99	105	106	101	96	92	140-8T/9-15	65	76	87	92	90	86	76	71
125-6T/6-5.5	59	68	81	84	85	82	71	67	140-8T/9-20	67	78	89	94	92	88	78	73
125-6T/6-7.5	60	69	82	85	86	83	72	68	160-6T/6-10	67	82	91	93	90	84	76	72
125-6T/6-10	61	70	83	86	87	84	73	69	160-6T/6-15	68	83	92	94	91	85	77	73
125-6T/6-15	63	72	85	88	89	86	75	71	160-6T/6-20	70	85	94	96	93	87	79	75
125-6T/6-20	65	74	87	90	91	88	77	73	160-6T/6-25	71	86	95	97	94	88	80	76
125-6T/6-25	66	75	88	91	92	89	78	74	160-6T/6-30	71	86	95	97	94	88	80	76
125-6T/9-10	57	67	82	86	85	84	73	69	160-6T/6-40	72	87	96	98	95	89	81	77
125-6T/9-15	59	69	84	88	87	86	75	71	160-6T/6-50	74	89	98	100	97	91	83	79
125-6T/9-20	62	72	87	91	90	89	78	74	160-6T/9-15	67	85	94	93	92	88	79	74
125-6T/9-25	64	74	89	93	92	91	80	76	160-6T/9-20	68	86	95	94	93	89	80	75
125-6T/9-30	66	76	91	95	94	93	82	78	160-6T/9-25	69	87	96	95	94	90	81	76
125-8T/6-3	53	61	73	78	77	72	61	57	160-6T/9-30	70	88	97	96	95	91	82	77
125-8T/6-4	54	62	74	79	78	73	62	58	160-6T/9-40	71	89	98	97	96	92	83	78
125-8T/6-5.5	56	64	76	81	80	75	64	60	160-6T/9-50	72	90	99	98	97	93	84	79
125-8T/6-7.5	58	66	78	83	82	77	66	62	160-6T/9-60	72	90	99	98	97	93	84	79
125-8T/6-10	59	67	79	84	83	78	67	63	160-6T/9-75	73	91	100	99	98	94	85	80
125-8T/9-4	51	62	72	78	79	74	63	59	160-6T/9-100	75	93	102	101	100	96	87	82
125-8T/9-5.5	53	64	74	80	81	76	65	61	160-8T/6-4	60	75	84	86	83	77	69	65
125-8T/9-7.5	56	67	77	83	84	79	68	64	160-8T/6-5.5	61	76	85	87	84	78	70	66
125-8T/9-10	58	69	79	85	86	81	70	66	160-8T/6-7.5	62	77	86	88	85	79	71	67
125-8T/9-15	59	70	80	86	87	82	71	67	160-8T/6-10	63	78	87	89	86	80	72	68
140-6T/6-5.5	66	81	90	92	89	83	75	71	160-8T/6-15	65	80	89	91	88	82	74	70
140-6T/6-7.5	67	82	91	93	90	84	76	72	160-8T/6-20	66	81	90	92	89	83	75	71
140-6T/6-10	68	83	92	94	91	85	77	73	160-8T/6-25	68	83	92	94	91	85	77	73
140-6T/6-15	69	84	93	95	92	86	78	74	160-8T/9-7.5	60	78	87	86	85	81	72	67
140-6T/6-20	71	86	95	97	94	88	80	76	160-8T/9-10	62	80	89	88	87	83	74	69
140-6T/6-25	72	87	96	98	95	89	81	77	160-8T/9-15	63	81	90	89	88	84	75	70
140-6T/6-30	73	88	97	99	96	90	82	78	160-8T/9-20	64	82	91	90	89	85	76	71
140-6T/9-10	66	84	93	92	91	87	78	73	160-8T/9-25	65	83	92	91	90	86	77	72
140-6T/9-15	67	85	94	93	92	88	79	74	160-8T/9-30	66	84	93	92	91	87	78	73
140-6T/9-20	69	87	96	95	94	90	81	76	160-8T/9-40	68	86	95	94	93	89	80	75

Accessories

See accessories section.



Dimensions mm

HGT

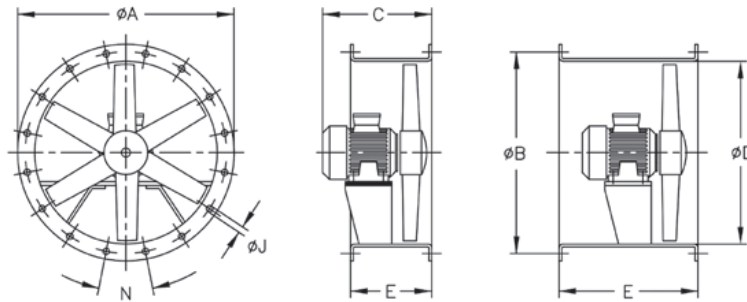

Model	ØA	ØB	C (Consult motor construction size)							ØD	E*		ØJ	N
			132	160	180	200	225	250	280		Short (STD)	long		
HGT-125	1365	1320	586	-	-	-	-	-	-	1250	500	700	15	20x18°
HGT-125	1365	1320	-	700	-	-	-	-	-	1250	500	700	15	20x18°
HGT-125	1365	1320	-	-	765	825	-	-	-	1250	700	900	15	20x18°
HGT-125	1365	1320	-	-	-	-	910	-	-	1250	700	1000	15	20x18°
HGT-125	1365	1320	-	-	-	-	-	985	-	1250	700	1000	15	20x18°
HGT-125	1365	1320	-	-	-	-	-	-	1190	1250	700	1200	15	20x18°
HGT-140	1515	1470	586	-	-	-	-	-	-	1400	400	650	15	20x18°
HGT-140	1515	1470	-	700	-	-	-	-	-	1400	450	700	15	20x18°
HGT-140	1515	1470	-	-	765	825	-	-	-	1400	550	900	15	20x18°
HGT-140	1515	1470	-	-	-	-	910	-	-	1400	550	1000	15	20x18°
HGT-140	1515	1470	-	-	-	-	-	985	-	1400	600	1000	15	20x18°
HGT-160	1735	1680	586	-	-	-	-	-	-	1600	400	650	19	24x15°
HGT-160	1735	1680	-	700	-	-	-	-	-	1600	450	700	19	24x15°
HGT-160	1735	1680	-	-	765	825	-	-	-	1600	550	900	19	24x15°
HGT-160	1735	1680	-	-	-	-	910	-	-	1600	550	1000	19	24x15°
HGT-160	1735	1680	-	-	-	-	-	985	-	1600	600	1000	19	24x15°
HGT-160	1735	1680	-	-	-	-	-	-	1190	1600	700	1200	19	24x15°

* Standard version supplied with short casing. Long casing with inspection hatch available on request.

Motor construction sizes depending on power

Poles	r/min	HP	3	4	5.5	7.5	10	15	20	25	30	40	50	60	75	100
4T	1500	-	-	-	-	-	132	160	160	180	180	200	225	225	250	280
6T	1000	-	132	132	132	160	160	180	200	200	225	250	280	280	280	-
8T	750	-	132	132	160	160	160	180	200	225	225	250	-	-	-	-

HGTX

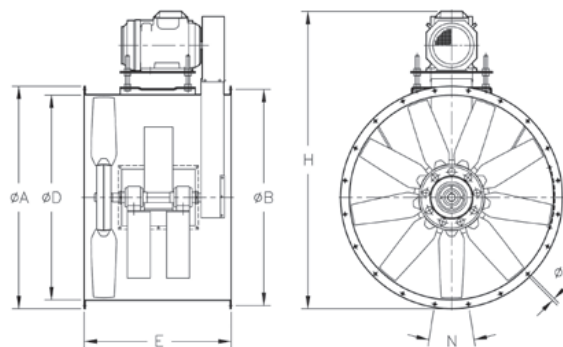

Model	ØA	ØB	ØD	E	H (Consult motor construction size)							ØJ	N	
					132	160	180	200	225	250	280			
HGT-X 125	1365	1320	1250	900	1743	1815	1850	-	-	-	-	-	15	20x18°
HGT-X 125	1365	1320	1250	960	-	-	-	1930	1995	-	-	-	15	20x18°
HGT-X 125	1365	1320	1250	1100	-	-	-	-	-	2060	-	-	15	20x18°
HGT-X 125	1365	1320	1250	1100	-	-	-	-	-	-	2090	-	15	20x18°

Motor construction sizes depending on power

Poles	r/min	HP	3	4	5.5	7.5	10	15	20	25	30	40	50	60	75	100
4T	1500	-	-	-	-	-	132	160	160	180	180	200	225	225	250	280
6T	1000	-	132	132	132	160	160	180	200	200	225	250	280	280	280	-
8T	750	-	132	132	160	160	160	180	200	225	225	250	-	-	-	-

SELECTION EXAMPLE

Characteristic curves

Q= Flow rate in m³/h, m³/s and cfm.

Pe= Static pressure in mm H₂O, Pa and inwg.

Impeller diameter (cm): 125 Number of poles: 8 Number of blades: 6

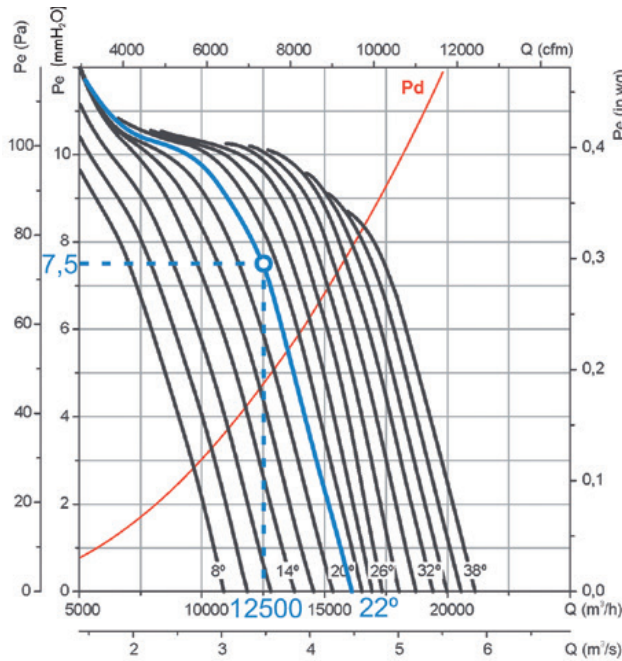

Starting data

- Working point:
- Flow rate: 12,500 m³/h
- Load loss: 7.5 mm H₂O

Equipment selection steps

On the pressure graph:

1. Mark the working point defined by the flow rate (12,500 m³/h) and the load loss (7.5 mm H₂O).
2. Select the nearest equipment curve above the working point. In this case, a blade angle curve of 22° is obtained.

On the power graph:

3. Mark the working point defined by the working flow rate (12,500 m³/h) and the selected blade angle curve (22°).
4. Read the absorbed power on the left power axis. Pa= 560 W at the working point.
5. Find the nearest straight red line above the working point. The installed motor power is given on the right side of the graph. In this case, 0.75 kW or 1 HP

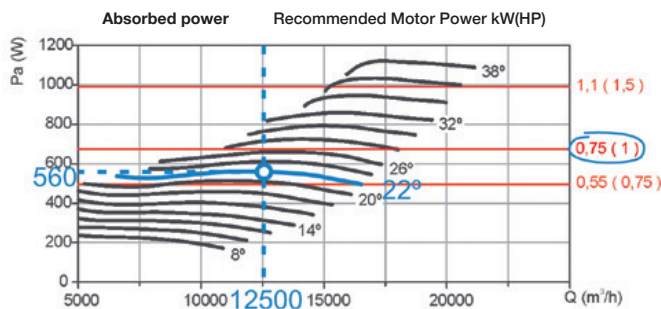

ORDER CODE EXAMPLE

HGT — 125 — 8T — 6 — 1 — 22

HGT: Tubular axial fans with large diameters and direct drive motors.
HGTX: Large diameter tubular axial fans with external motors.

Impeller diameter in cm

Number of motor poles
4=1400 r/min. 50 Hz
6=900 r/min. 50 Hz
8=750 r/min. 50 Hz

T= Three-phase
M= Single-phase

Number of blades
6 blades
9 blades

Motor power (HP)

Blade inclination angle

Characteristic curves

Q= Flow rate in m³/h, m³/s and cfm.

Pe= Static pressure in mm H₂O, Pa and inwg.

Impeller diameter (cm): 125

Number of poles: 4

Number of blades: 6

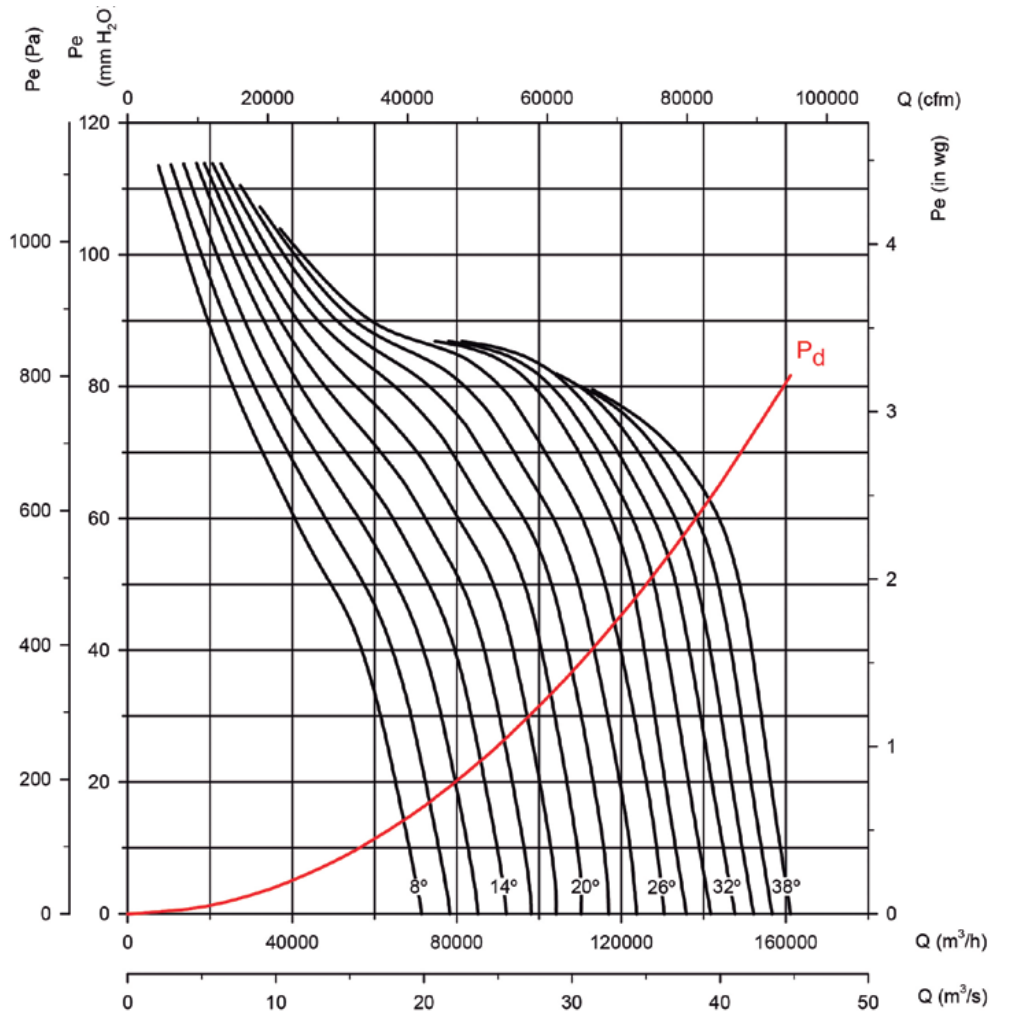

Absorbed power

Recommended Motor Power kW(HP)

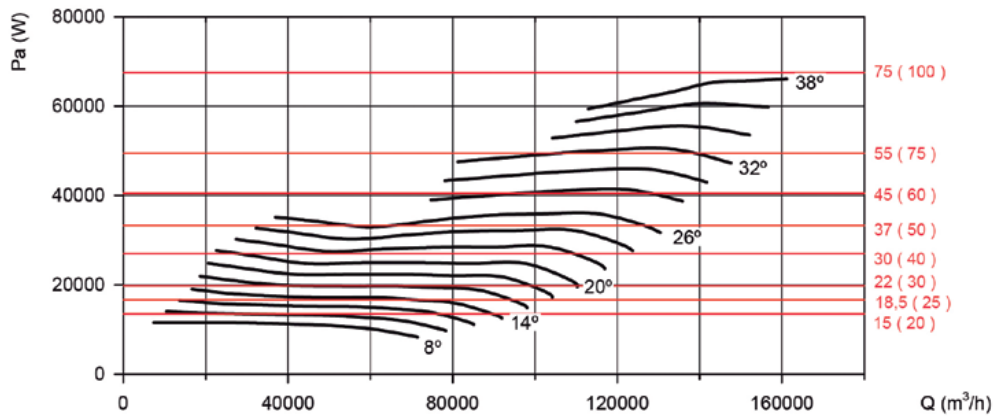

Characteristic curves

Q= Flow rate in m³/h, m³/s and cfm.

Pe= Static pressure in mm H₂O, Pa and inwg.

Impeller diameter (cm): 125

Number of poles: 4

Number of blades: 9

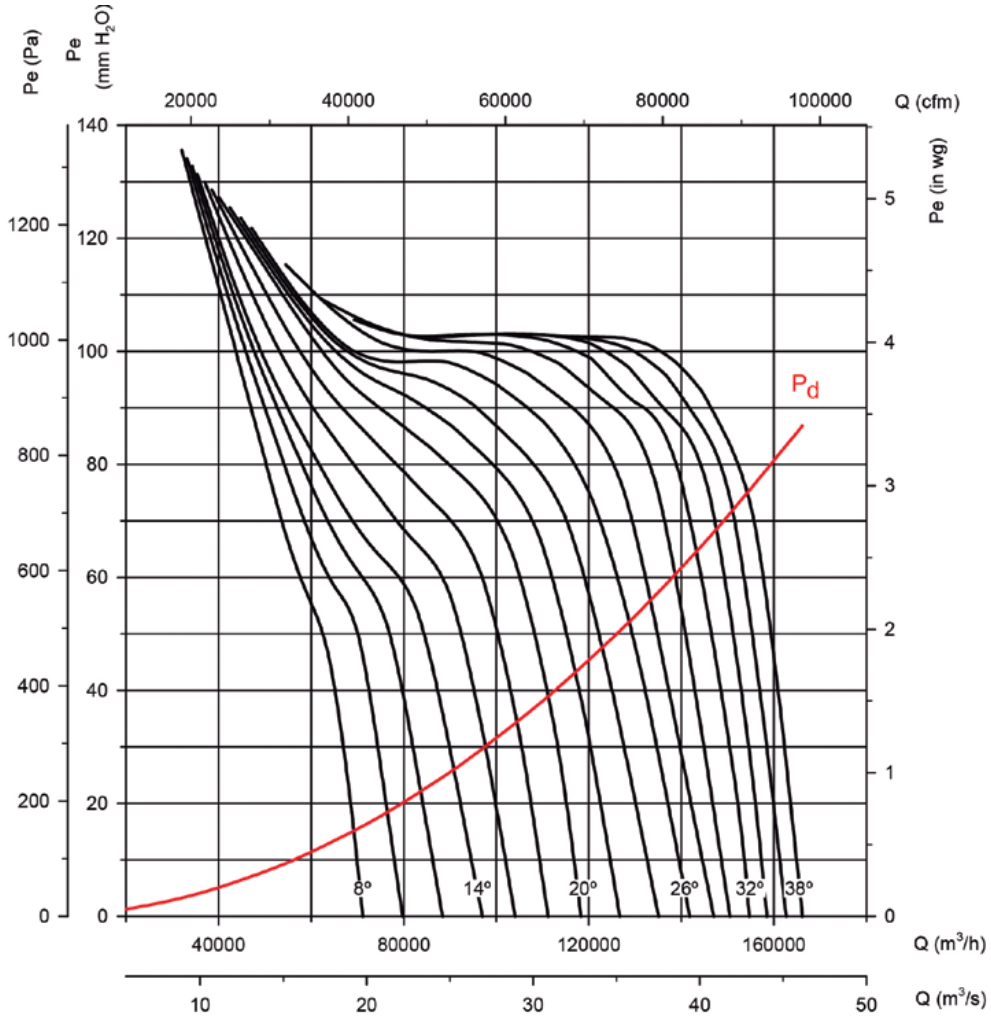

Absorbed power

Recommended Motor Power kW(HP)

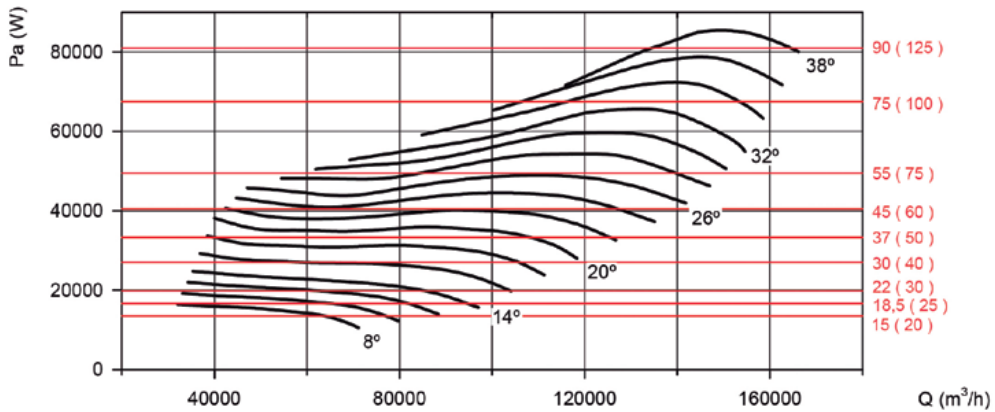

Characteristic curves

Q= Flow rate in m³/h, m³/s and cfm.

Pe= Static pressure in mm H₂O, Pa and inwg.

Impeller diameter (cm): 125

Number of poles: 6

Number of blades: 6

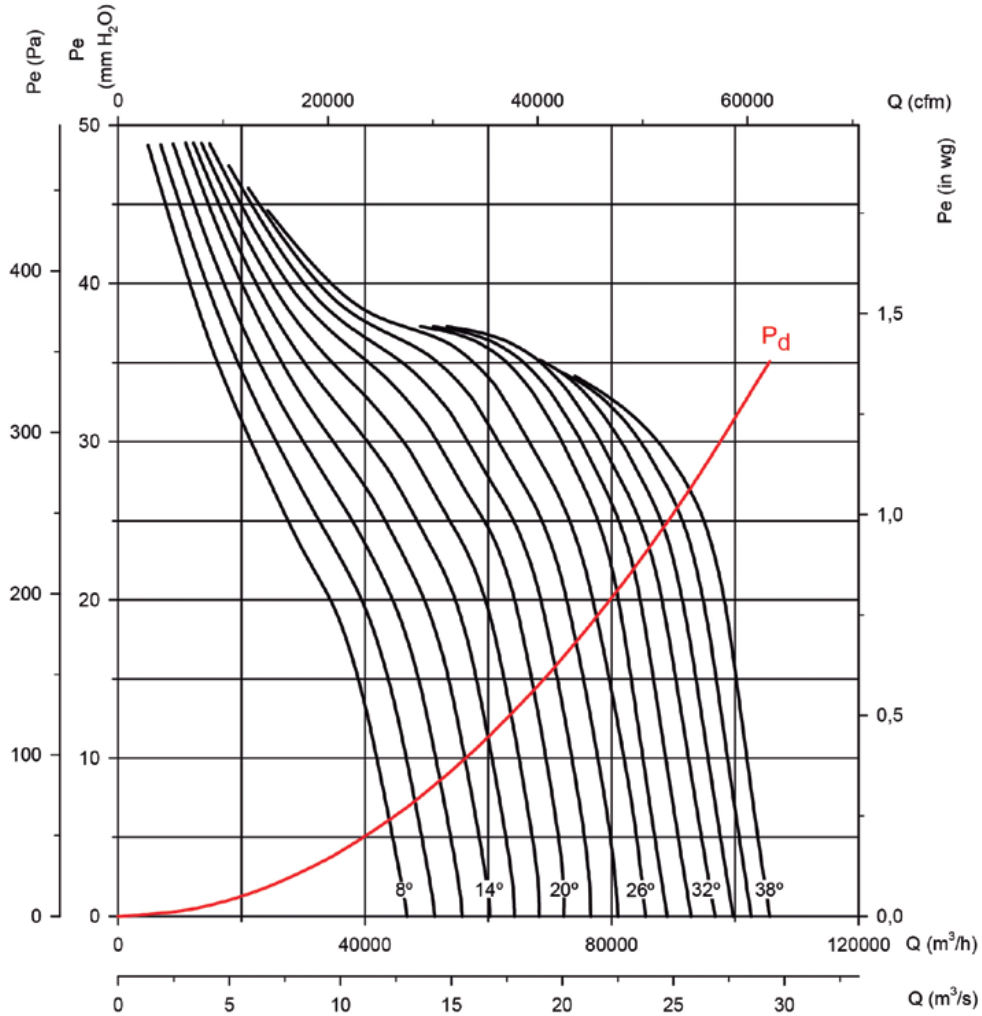

Absorbed power

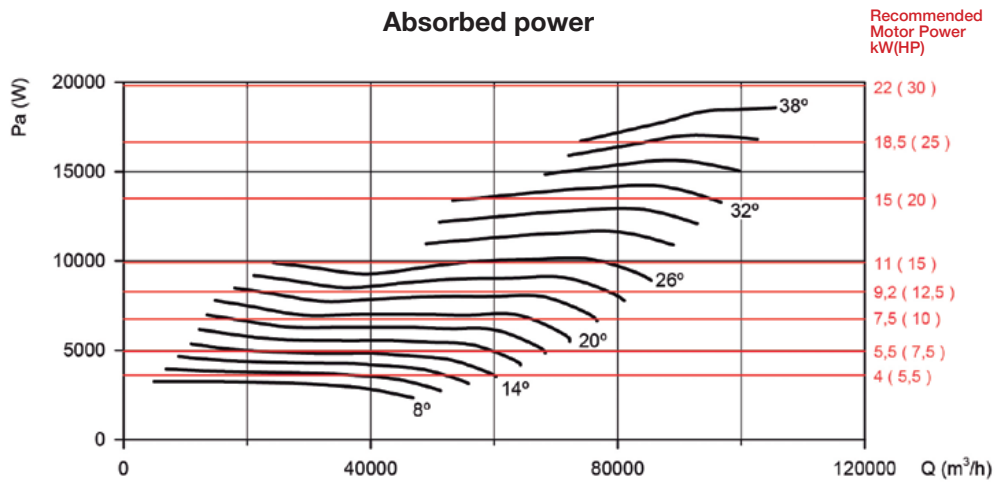

Characteristic curves

Q= Flow rate in m³/h, m³/s and cfm.

Pe= Static pressure in mm H₂O, Pa and inwg.

Impeller diameter (cm): 125

Number of poles: 6

Number of blades: 9

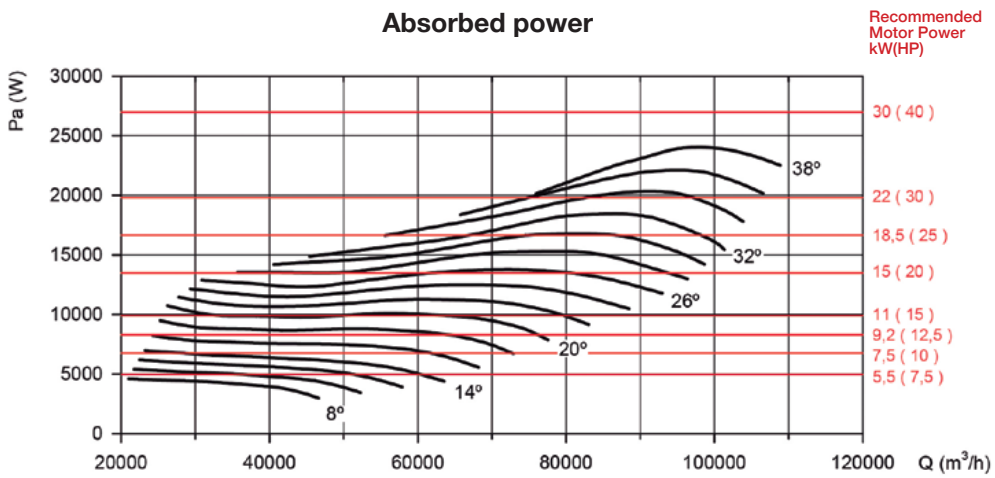
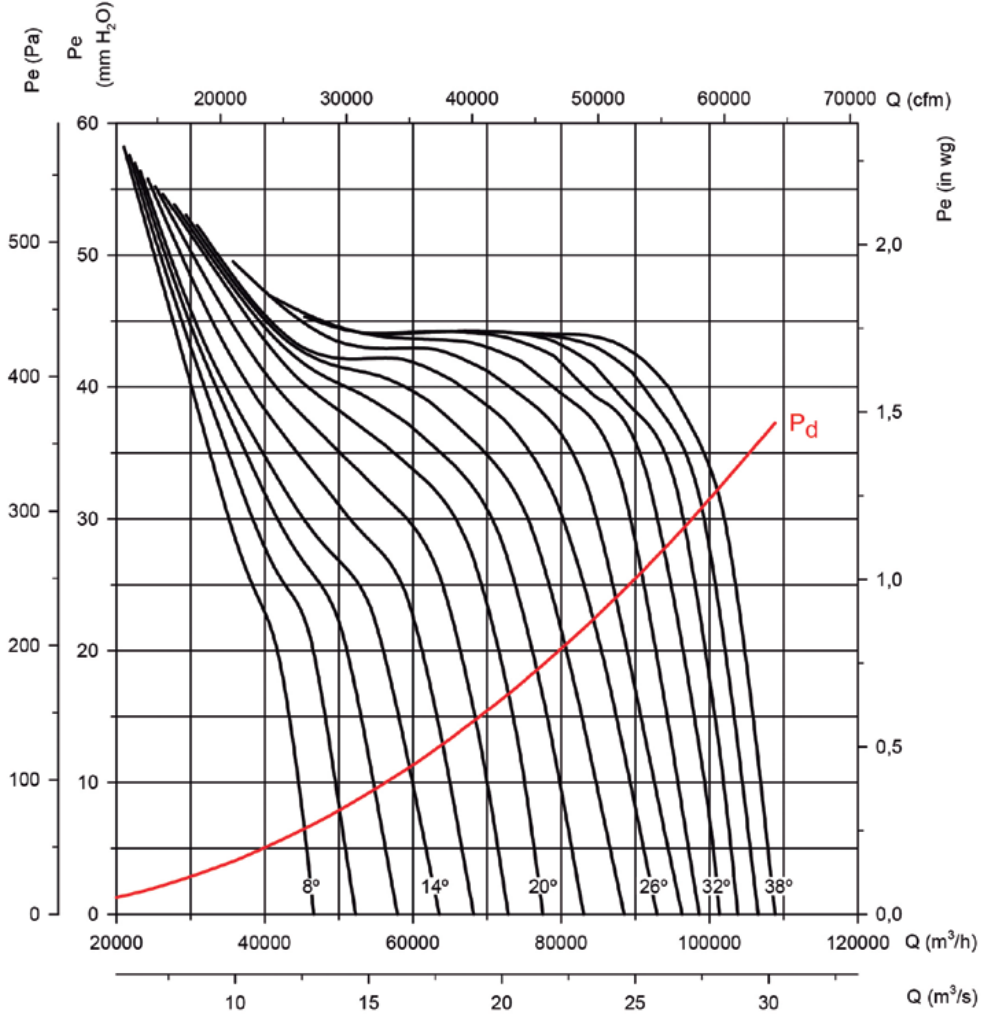

Characteristic curves

Q= Flow rate in m³/h, m³/s and cfm.

Pe= Static pressure in mm H₂O, Pa and inwg.

Impeller diameter (cm): 125

Number of poles: 8

Number of blades: 6

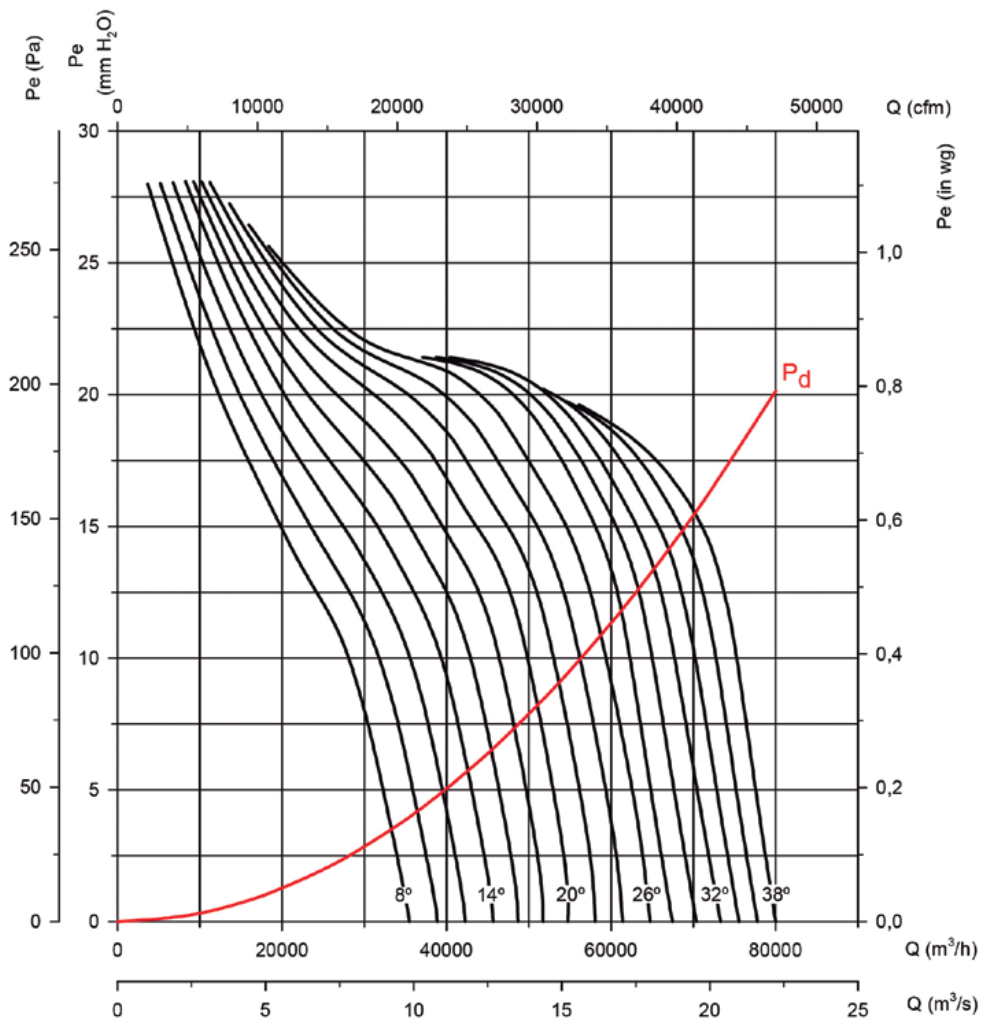

Absorbed power

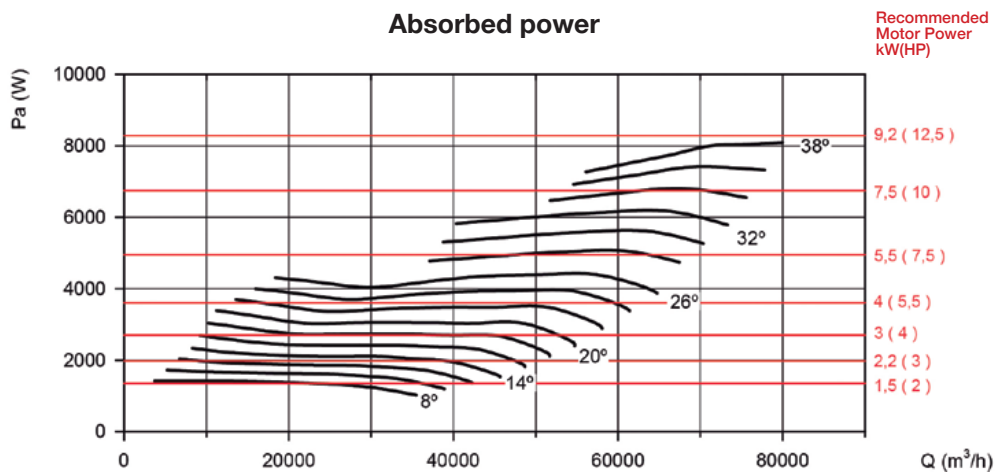

Characteristic curves

Q= Flow rate in m³/h, m³/s and cfm.

Pe= Static pressure in mm H₂O, Pa and inwg.

Impeller diameter (cm): 125

Number of poles: 8

Number of blades: 9

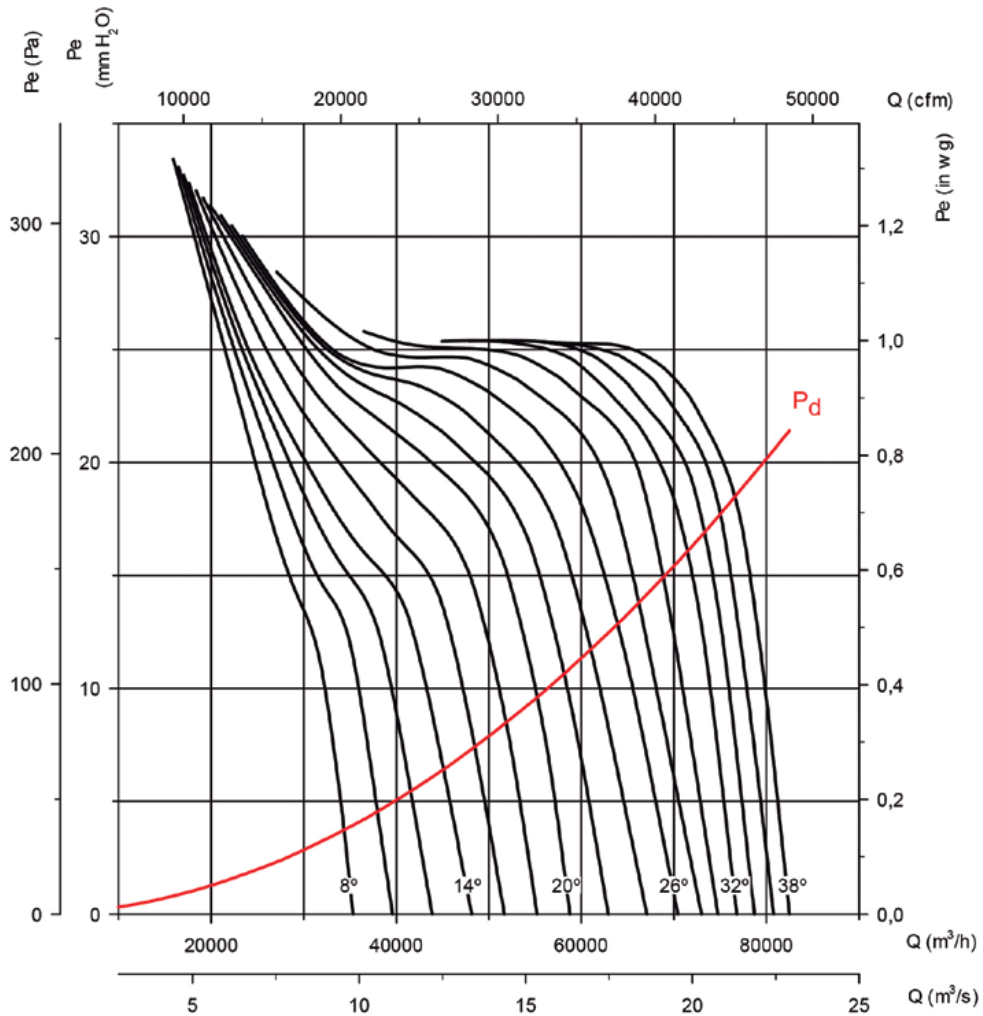

Absorbed power

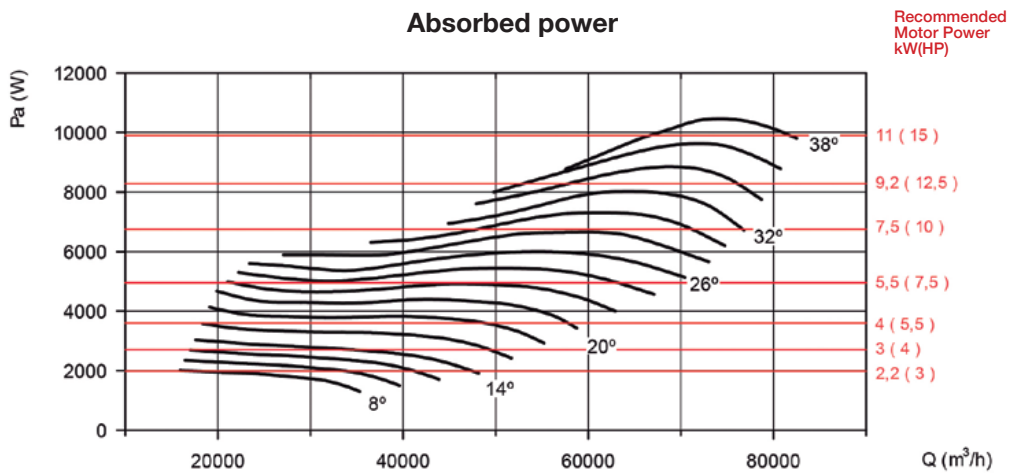

Characteristic curves

Q= Flow rate in m³/h, m³/s and cfm.

Pe= Static pressure in mm H₂O, Pa and inwg.

Impeller diameter (cm): 140

Number of poles: 6

Number of blades: 6

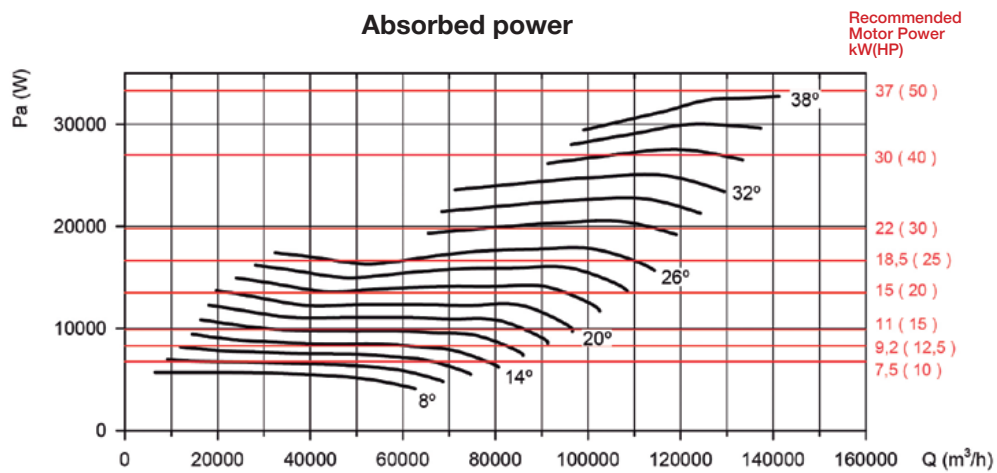
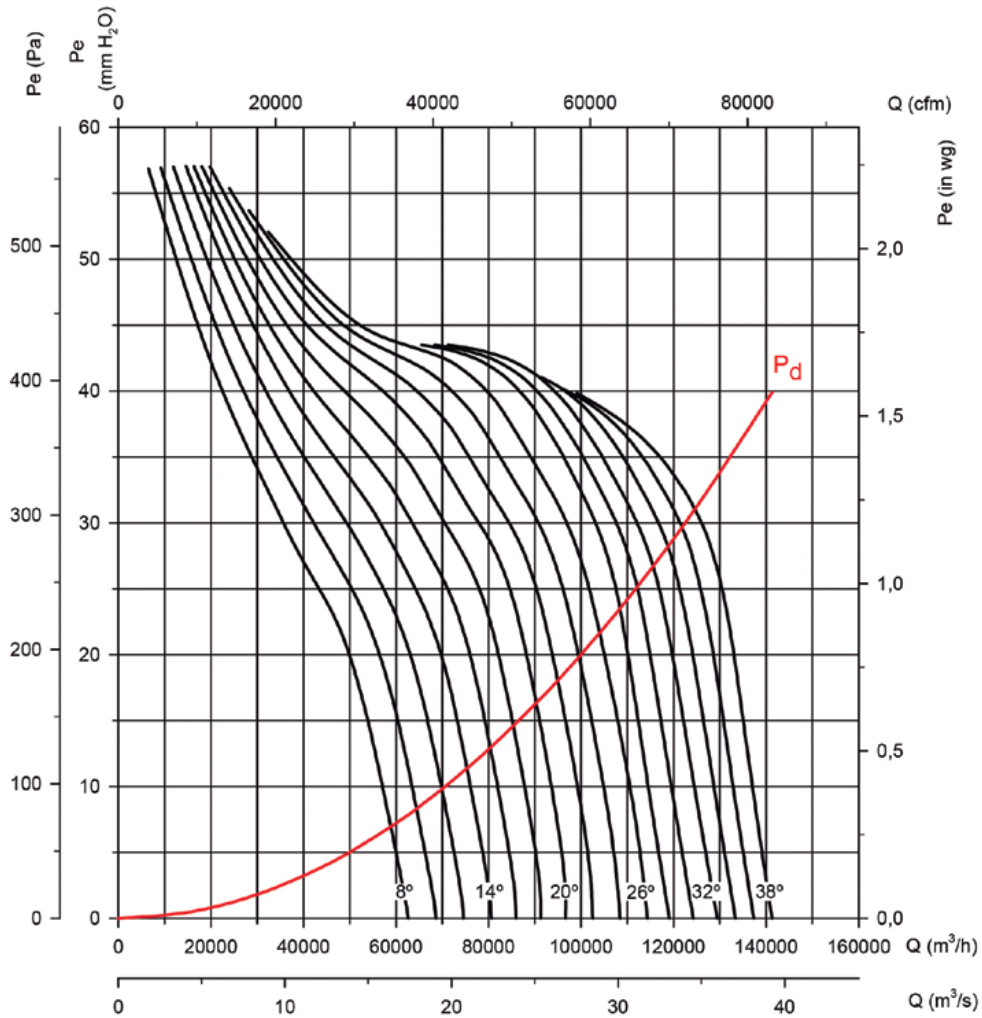

Characteristic curves

Q= Flow rate in m³/h, m³/s and cfm.

Pe= Static pressure in mm H₂O, Pa and inwg.

Impeller diameter (cm): 140

Number of poles: 6

Number of blades: 9

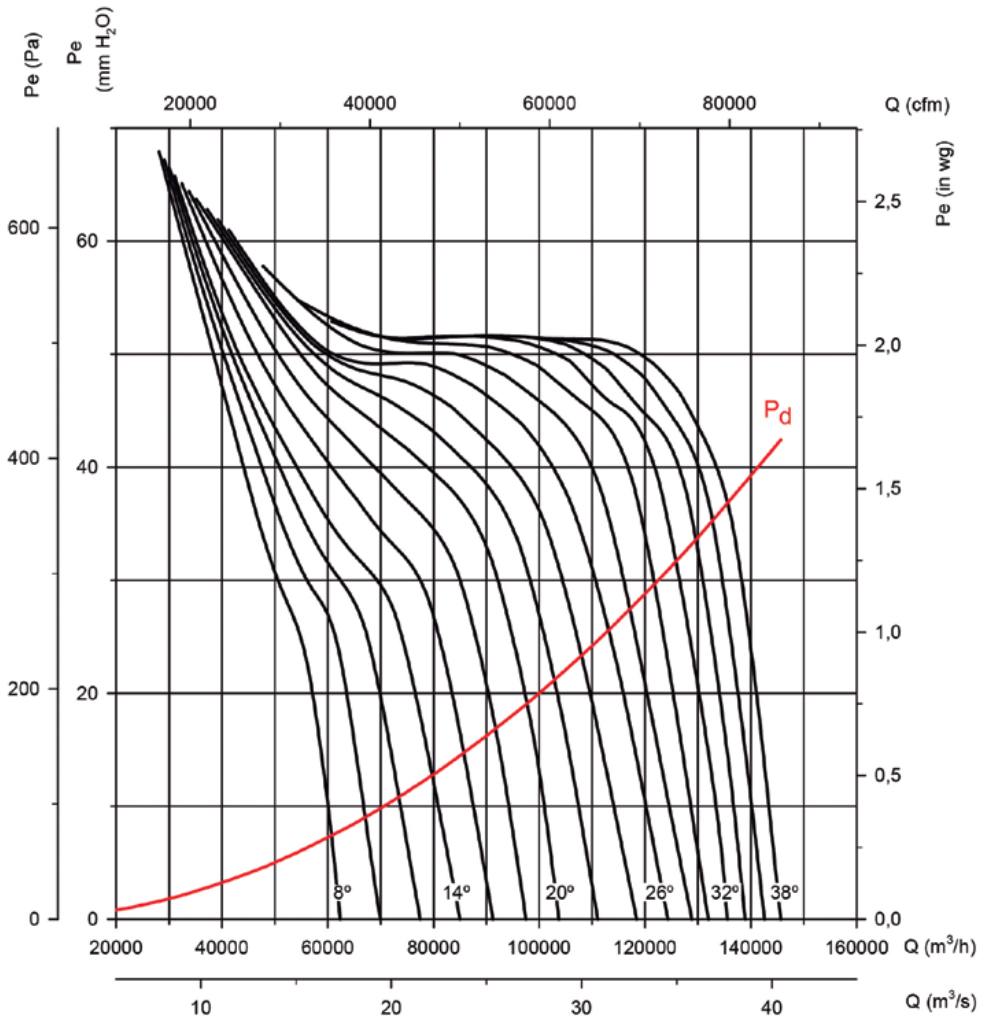

Absorbed power

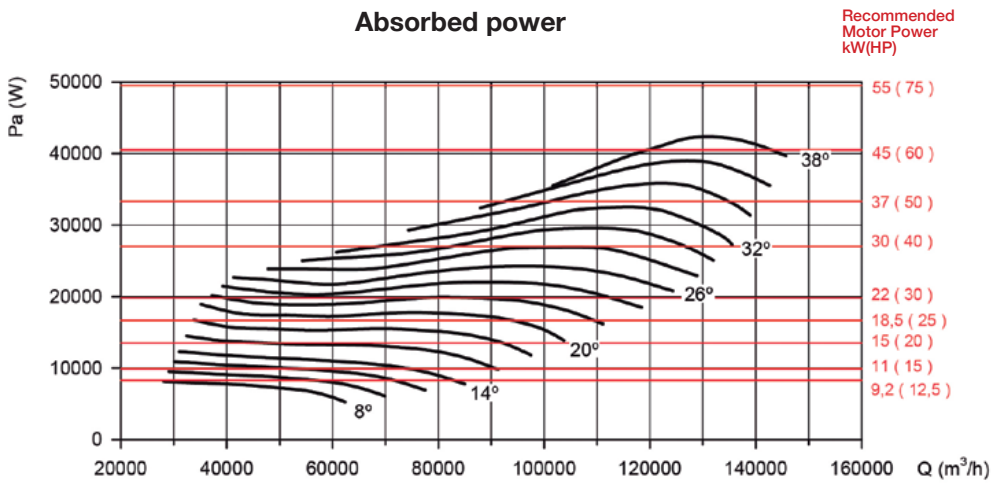

Characteristic curves

Q= Flow rate in m³/h, m³/s and cfm.

Pe= Static pressure in mm H₂O, Pa and inwg.

Impeller diameter (cm): 140

Number of poles: 8

Number of blades: 6

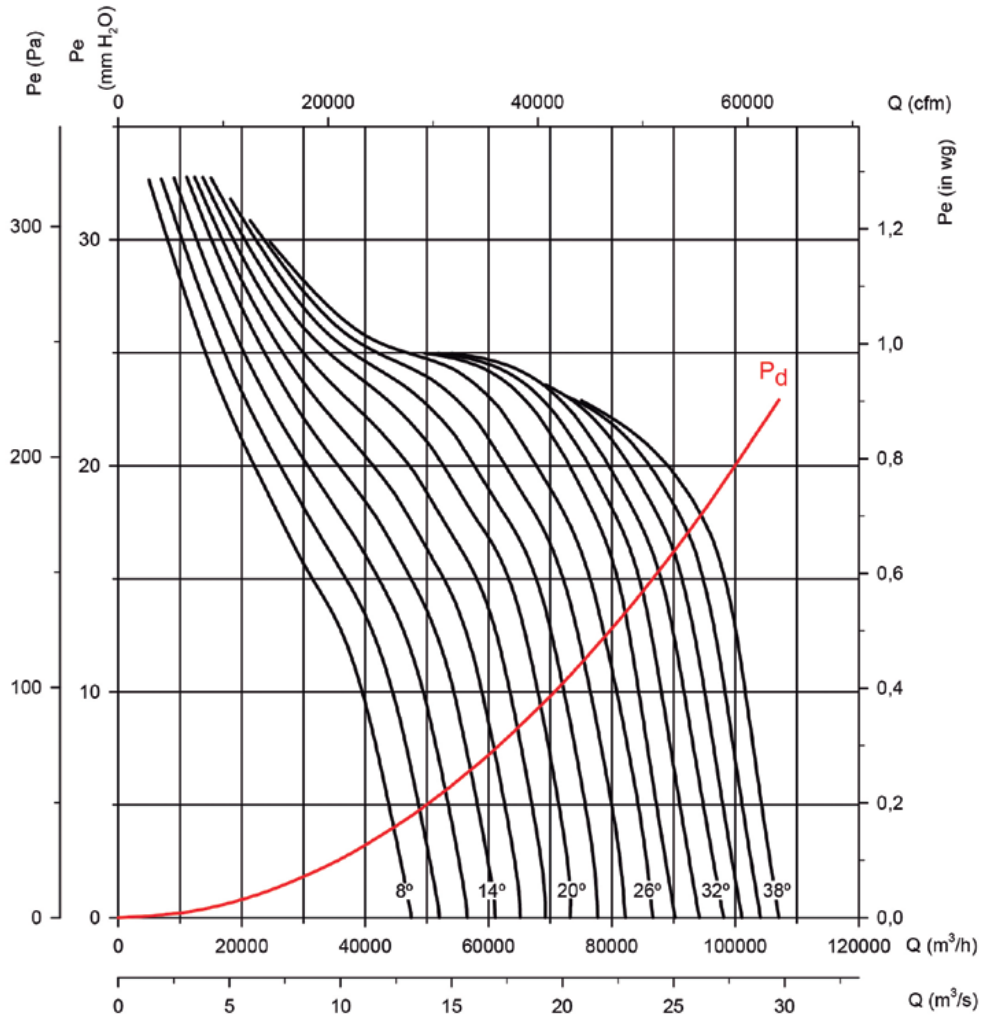

Absorbed power

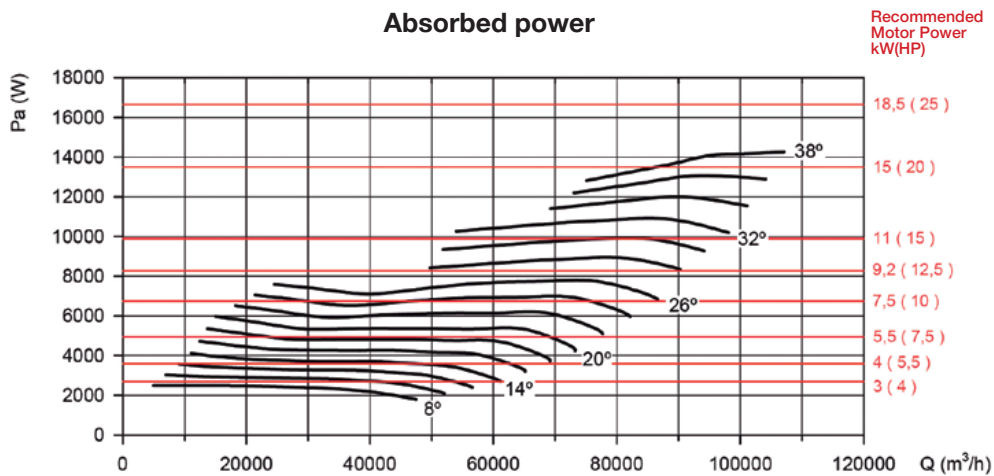

Characteristic curves

Q= Flow rate in m³/h, m³/s and cfm.

Pe= Static pressure in mm H₂O, Pa and inwg.

Impeller diameter (cm): 140

Number of poles: 8

Number of blades: 9

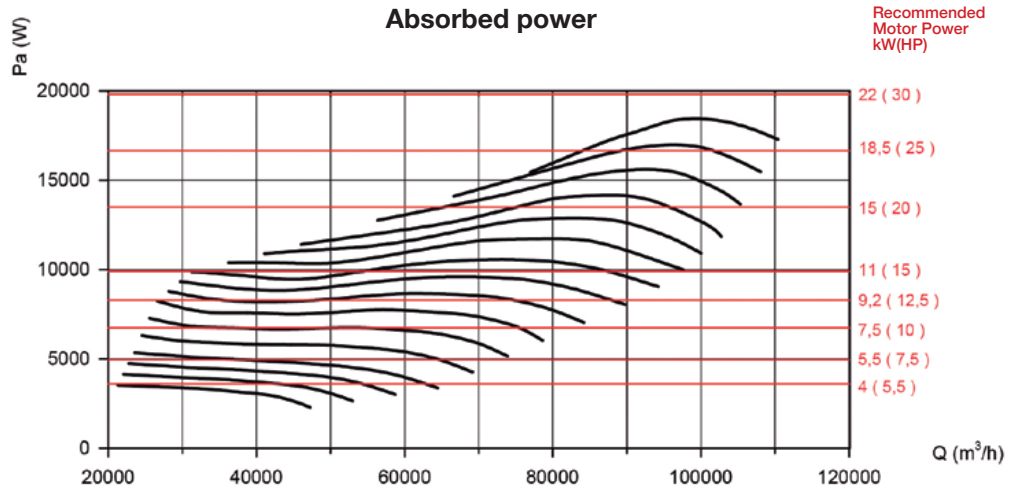
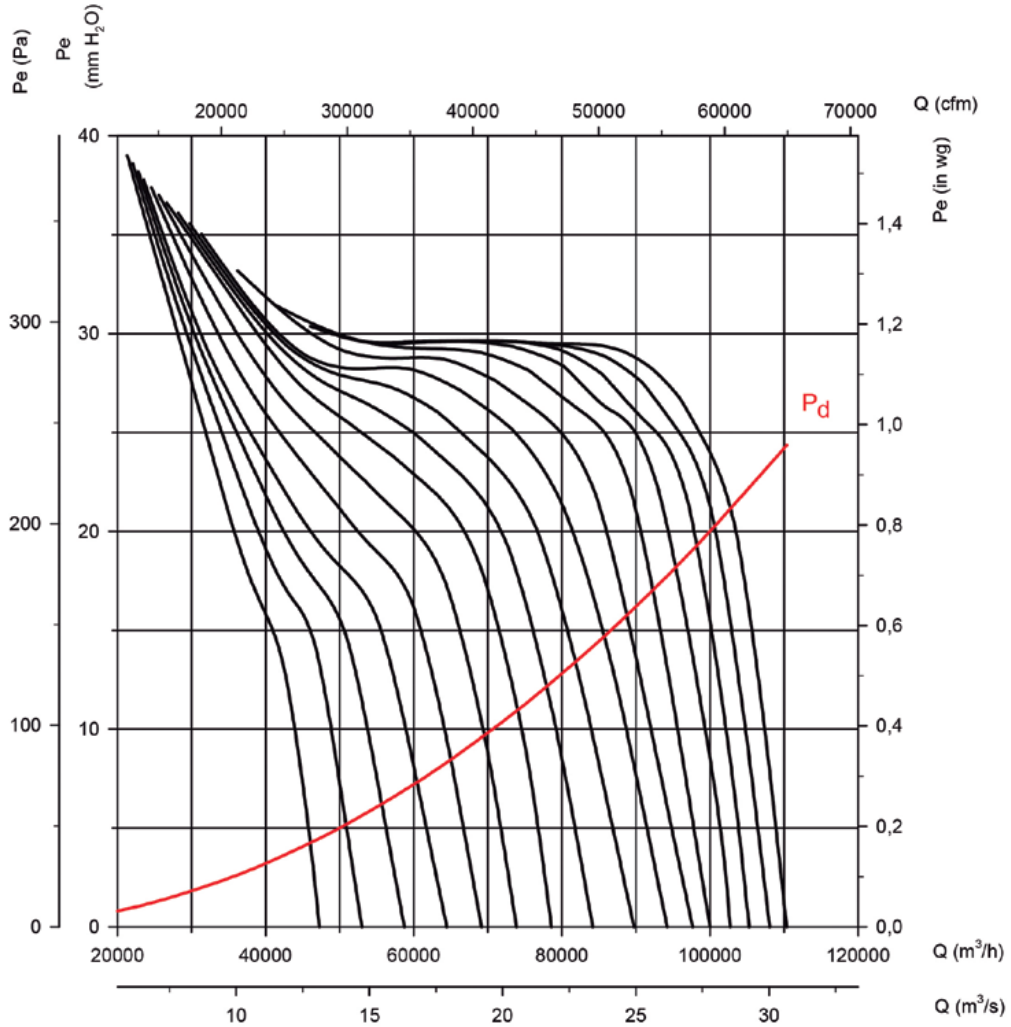

Characteristic curves

Q= Flow rate in m³/h, m³/s and cfm.

Pe= Static pressure in mm H₂O, Pa and inwg.

Impeller diameter (cm): 160

Number of poles: 6

Number of blades: 6

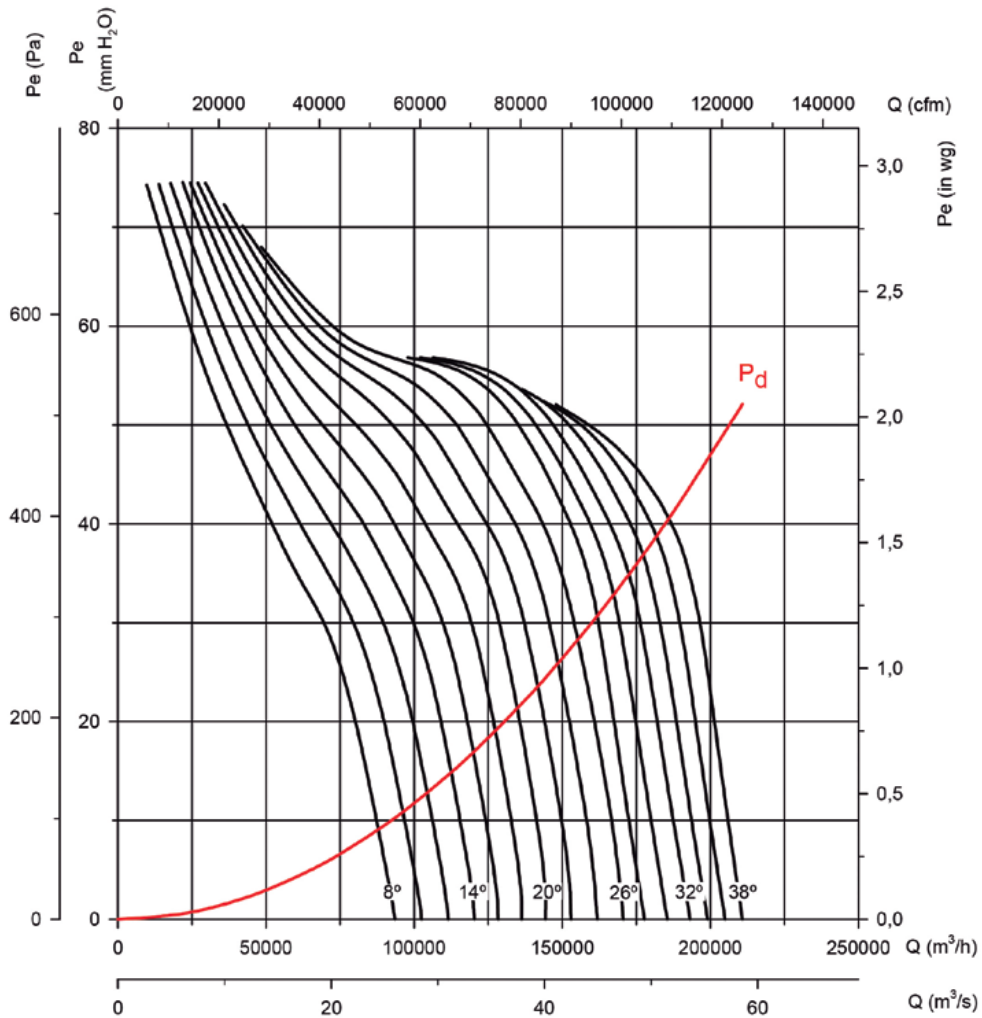

Absorbed power

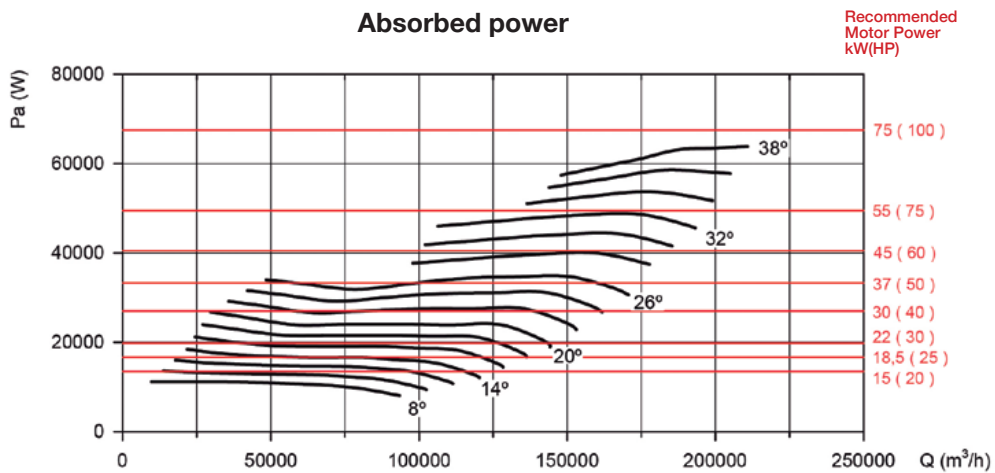

Characteristic curves

Q= Flow rate in m³/h, m³/s and cfm.

Pe= Static pressure in mm H₂O, Pa and inwg.

Impeller diameter (cm): 160

Number of poles: 6

Number of blades: 9

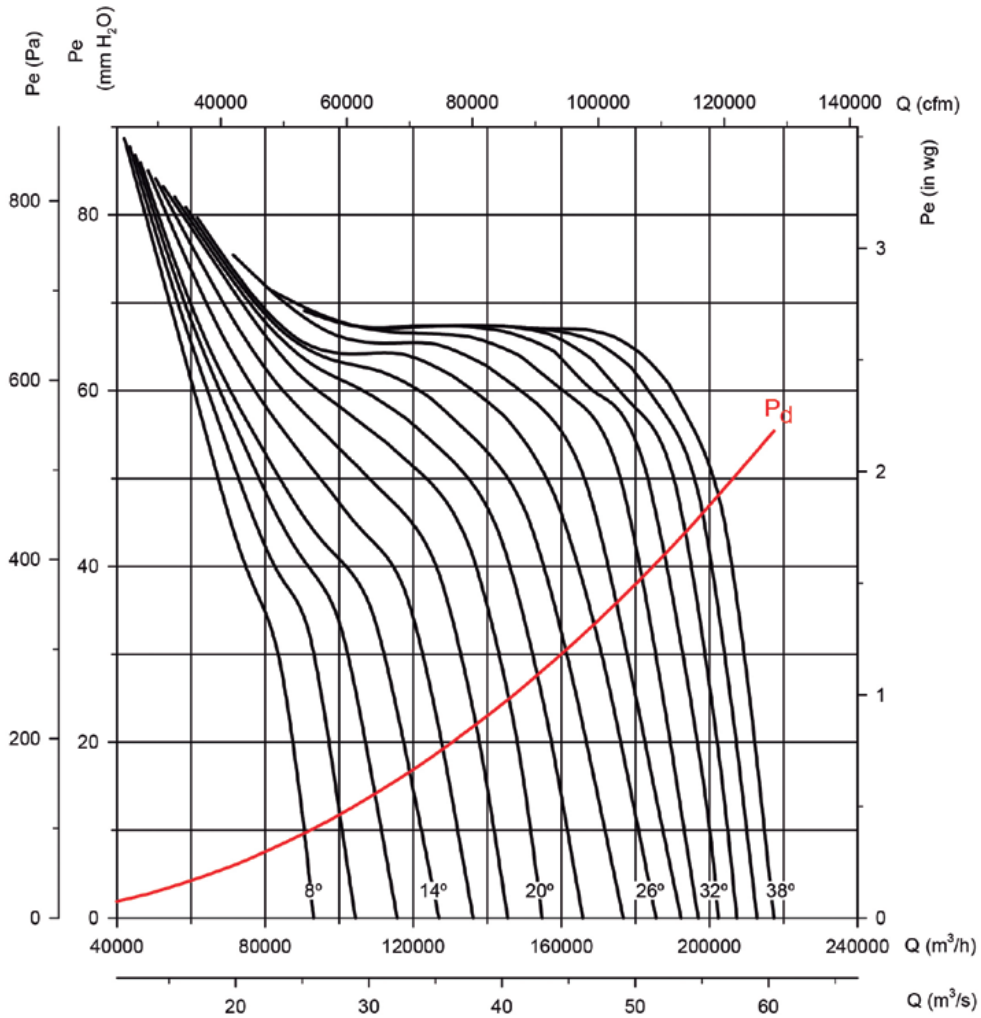

Absorbed power

Recommended Motor Power kW(HP)

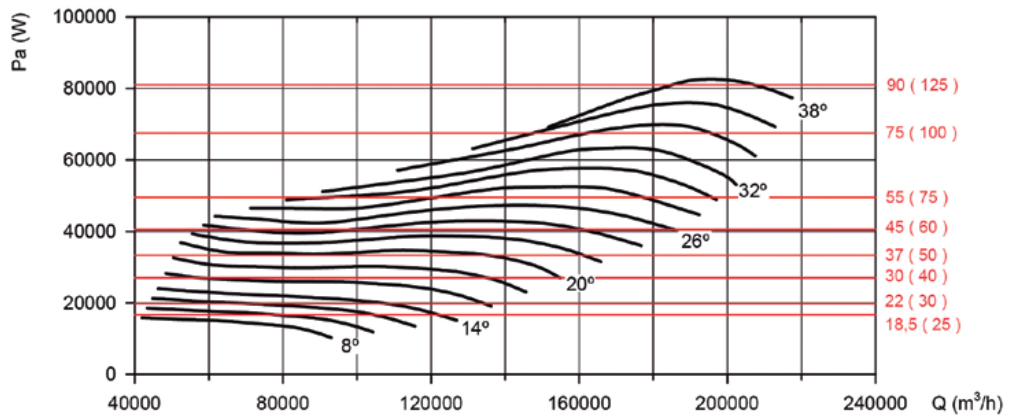

Characteristic curves

Q= Flow rate in m³/h, m³/s and cfm.

Pe= Static pressure in mm H₂O, Pa and inwg.

Impeller diameter (cm): 160

Number of poles: 8

Number of blades: 6

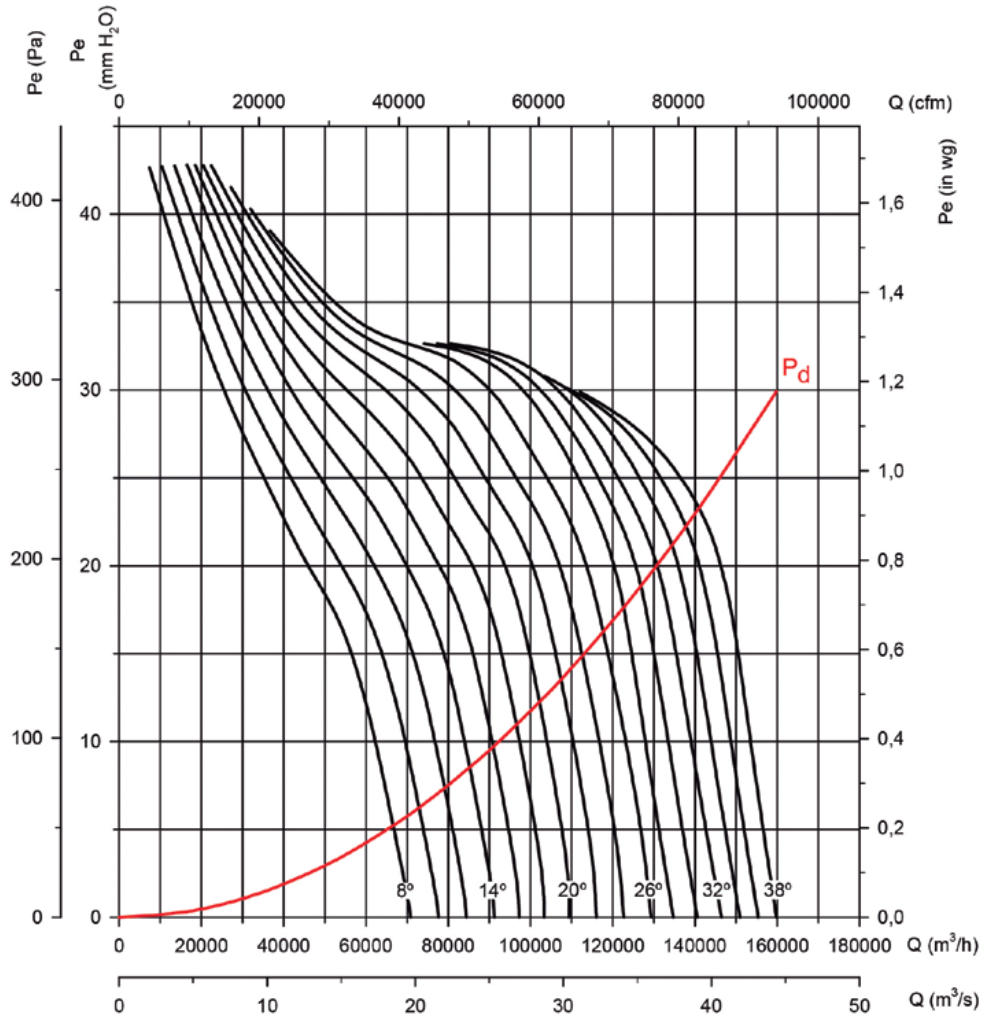

Absorbed power

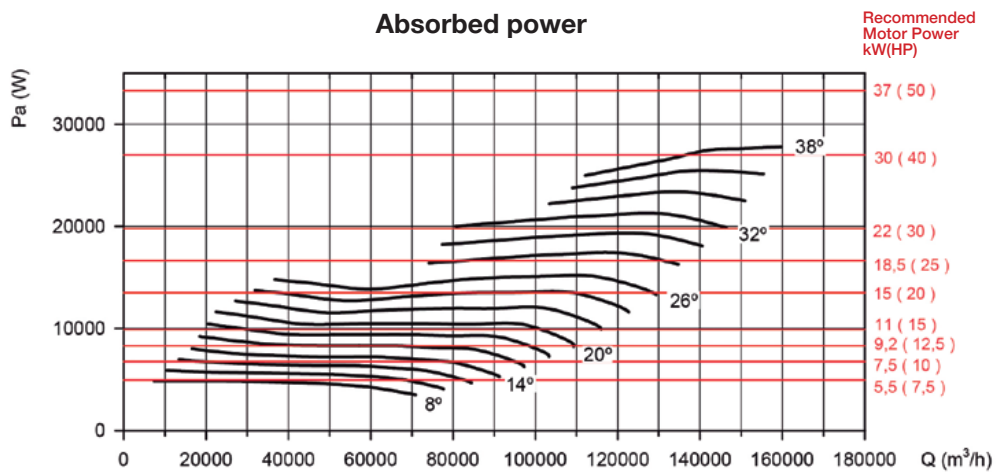

Characteristic curves

Q= Flow rate in m³/h, m³/s and cfm.

Pe= Static pressure in mm H₂O, Pa and inwg.

Impeller diameter (cm): 160

Number of poles: 8

Number of blades: 9

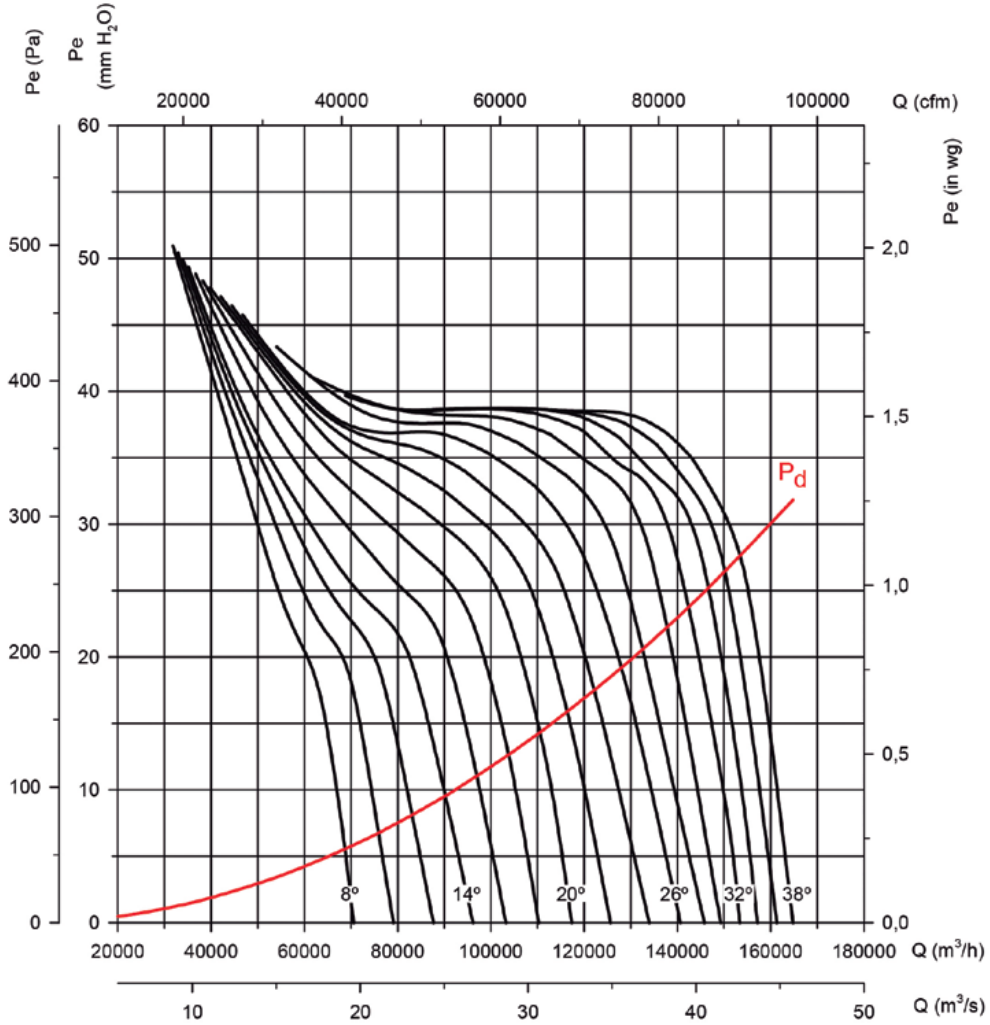

Absorbed power

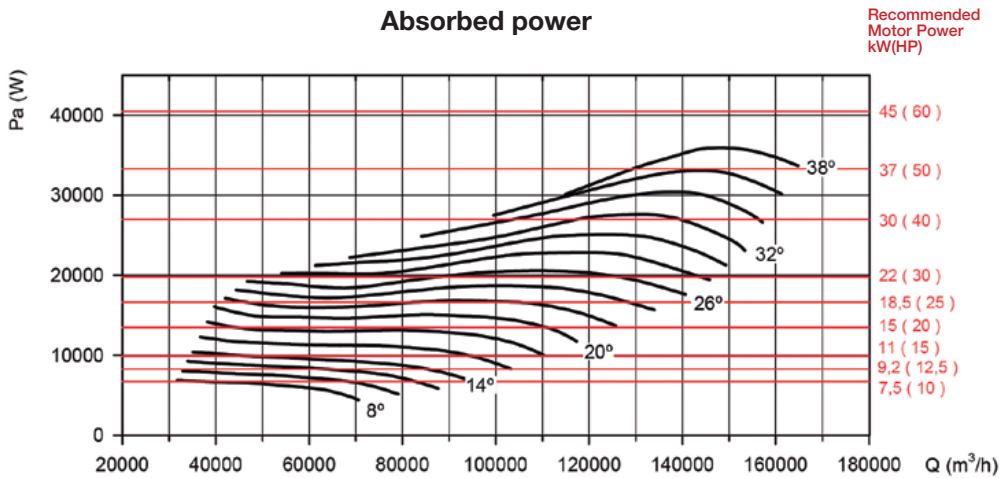

HTM

Tubular mobile axial fans



Mobile fans in which the airflow can be varied.

Fan:

- Tubular sheet steel casing.
- Fibreglass-reinforced polyamide-6 impeller.
- Anti-contact protective grille pursuant to standard UNE-EN ISO 12499 on both sides.
- Manually resettable junction box with on - off switch to prevent accidental start-up (EN ISO 12100).
- Airflow direction from motor to impeller.
- Fan switch fitted with a built-in CETAC P17 plug for:
 - Three-phase 3P + T 16A motors
 - Single-phase 2P + T 16A motors

Motor:

- IE3 efficiency motors for powers equal to or higher than 0.75kW except single-phase, 2-speed and 8-pole.

- Class F motors with ball bearings, IP55 protection, except single-phase models from size 35 to size 56, IP54 protection.
- Single-phase 230V-50Hz and three-phase 230/400V-50Hz.
- Operating temperature: -25°C+ 50°C.

Finish:

- Anti-corrosive finish of polyester resin polymerised at 190°C, previously degreased with phosphate-free nanotechnological treatment.

On request:

- Airflow direction from impeller to motor.
- 100% reversible impellers.
- Special windings for different voltages.
- ATEX-certified Category 2.

Order code

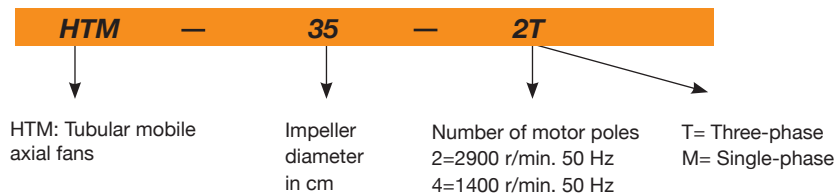

Technical characteristics

Model	Speed (r/min)	Maximum admissible current (A)		Installed power (kW)	Max. flow rate (m ³ /h)	Sound pressure level dB(A)	Approx. weight (kg)	According to ErP
		230 V	400 V					
HTM-35-2T	2710	1.92	1.11	0.37	5750	77	13	2015
HTM-35-2M	2780	2.53		0.37	5750	77	13	2015
HTM-35-4T	1320	0.65	0.38	0.09	3100	59	12	2015
HTM-35-4M	1380	0.65		0.09	3100	59	12	2015
HTM-40-4T	1350	1.66	0.96	0.25	5150	64	19	2015
HTM-40-4M	1370	2.00		0.25	5150	64	19	2015
HTM-45-4T	1370	2.02	1.17	0.37	7100	68	22	2015
HTM-45-4M	1400	2.76		0.37	7100	68	22	2015
HTM-56-4T	1380	2.92	1.69	0.55	11050	72	27	2015
HTM-56-4M	1450	4.40		0.55	11050	72	27	2015
HTM-63-4T IE3	1455	4.07	2.34	1.1	17000	74	39	2015

Acoustic characteristics

The indicated values are determined by measuring the sound pressure level and sound power in dB(A) obtained in a free field at a distance equivalent to twice the size of the fan plus the impeller diameter, with a minimum of 1.5 m.

Sound power spectrum Lw(A) in dB(A) per Hz frequency band

Model	63	125	250	500	1000	2000	4000	8000	Model	63	125	250	500	1000	2000	4000	8000
35-2	42	59	71	79	84	84	80	73	45-4	33	50	62	70	75	75	71	64
35-4	24	41	53	61	66	66	62	55	56-4	39	56	69	76	81	82	77	70
40-4	29	46	58	66	71	71	67	60	63-4	43	60	73	80	85	86	81	74

Dimensions mm

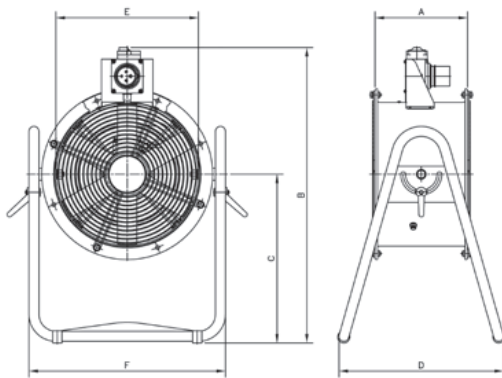

Model	A	B	C	D	E	F
HTM-35	280	736	420	415	355	489
HTM-40	320	775	481	450	410	596
HTM-45	360	795	481	453	460	596
HTM-56	400	945	594	522	560	726
HTM-63	430	978	594	522	640	805

Blade characteristics with the fan at a distance of 1 metre from point 0

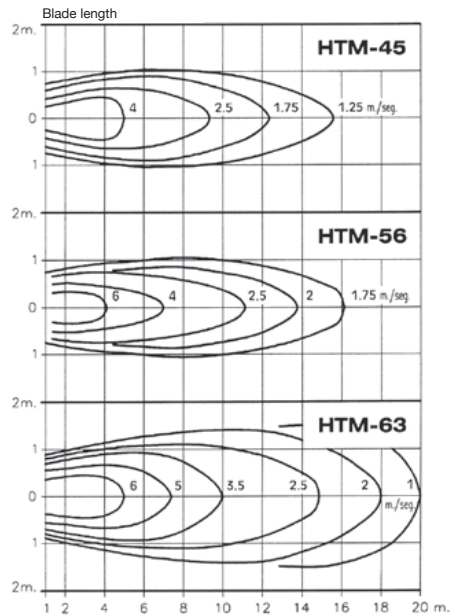
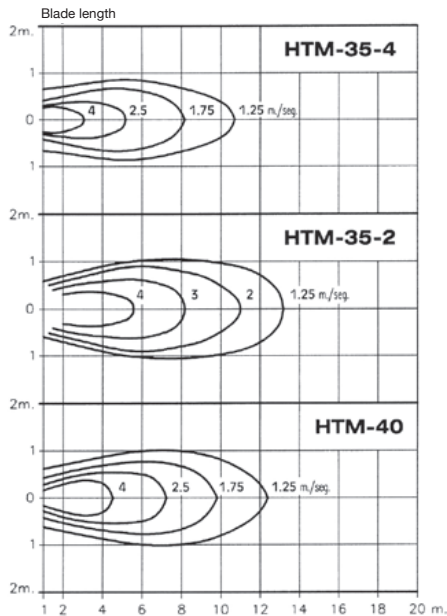

Accessories

See accessories section.



HPX

Tubular axial fans with external motors



Belt-driven tubular axial fans with casing aperture up to 180°.

Fan:

- Tubular casing with rotating cap, in sheet steel.
- Cast aluminium impellers.
- Sealed transmission unit (IP66) with double retention system.
- Airflow direction from motor to impeller.
- Maximum temperature of air to be carried: -25°C +120°C.

Motor:

- IE3 efficiency motors for powers equal to or higher than 0.75kW except single-phase, 2-speed and 8-pole.
- Class F motors with ball bearings and IP55 protection.

- Single-phase 230V-50Hz and three-phase 230/400V-50Hz (up to 4kW) and 400/690V-50Hz (powers higher than 4kW).

Finish:

- Anti-corrosive finish of polyester resin polymerised at 190°C, previously degreased with phosphate-free nanotechnological treatment.

On request:

- Airflow direction from impeller to motor.
- 100% reversible impellers.
- Special windings for different voltages.
- Category 2 ATEX certification (HPX/ATEX series version).

Order code

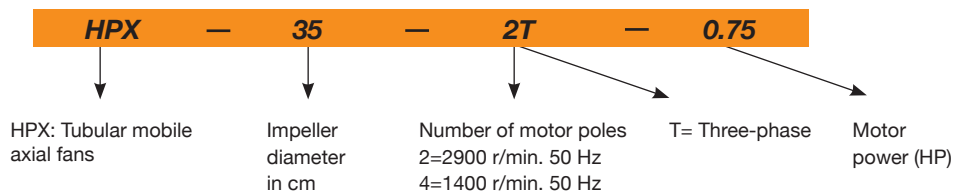

Technical characteristics

Model	Speed (r/min)	Maximum admissible current (A)			Installed power (kW)	Max. flow rate (m³/h)	Sound pressure level dB(A)	Approx. weight (kg)
		230V	400V	690V				
HPX-35-2T-0.75	2720	2.57	1.49		0.55	4750	77	22
HPX-35-4T-0.33	1420	1.66	0.96		0.25	2500	60	20
HPX-45-4T-0.33	1200	1.66	0.96		0.25	6300	69	32
HPX-45-4T-0.5	1420	2.02	1.17		0.37	6600	70	36
HPX-50-4T-0.75	1310	2.92	1.69		0.55	9000	70	33
HPX-50-4T-1 IE3	1500	2.82	1.62		0.75	10800	71	35
HPX-56-4T-0.75	1380	2.92	1.69		0.55	11300	72	36
HPX-56-4T-1 IE3	1420	2.82	1.62		0.75	12200	73	37
HPX-56-4T-1.5 IE3	1420	4.07	2.34		1.10	14500	75	43
HPX-63-4T-1.5 IE3	1300	4.07	2.34		1.10	16000	74	63
HPX-63-4T-2 IE3	1420	5.41	3.11		1.50	17500	78	71
HPX-71-4T-1.5 IE3	1200	4.07	2.34		1.10	20300	78	78
HPX-71-4T-2 IE3	1350	5.41	3.11		1.50	22500	79	85
HPX-71-4T-3 IE3	1450	7.93	4.56		2.20	24000	81	86
HPX-80-4T-4 IE3	1350	10.70	6.15		3.00	32000	84	105
HPX-80-4T-5.5 IE3	1450	13.90	8.00		4.00	40500	84	108
HPX-90-4T-5.5 IE3	1280	13.90	8.00		4.00	44000	89	120
HPX-90-4T-7.5 IE3	1400		10.30	5.97	5.50	51000	91	155
HPX-100-4T-10 IE3	1450		13.90	8.06	7.50	63000	93	175
HPX-100-4T-15 IE3	1450		20.90	12.10	11.00	68000	94	206

Acoustic characteristics

The indicated values are determined by measuring the sound pressure level and sound power in dB(A) obtained in a free field at a distance equivalent to twice the size of the fan plus the impeller diameter, with a minimum of 1.5 m.

Noise power spectrum Lw(A) in dB(A) frequency band in [Hz]

Model	63	125	250	500	1000	2000	4000	8000	Model	63	125	250	500	1000	2000	4000	8000
35-2-0.75	48	63	82	81	82	81	76	67	63-4-2	62	73	83	89	90	85	74	70
35-4-0.33	31	46	65	64	65	64	59	50	71-4-1.5	55	75	83	88	90	87	80	69
45-4-0.33	40	55	74	73	74	73	68	59	74-4-2	56	76	84	89	91	88	81	70
45-4-0.50	41	56	75	74	75	74	69	60	71-4-3	65	76	86	92	93	88	77	73
50-4-0.75	44	58	77	77	78	76	72	63	80-4-4	61	81	89	94	96	93	86	75
50-4-1	45	59	78	78	79	77	73	64	80-4-5.5	68	79	89	95	96	91	80	76
56-4-0.75	47	67	75	80	82	79	72	61	90-4-5.5	67	88	95	100	103	99	92	81
56-4-1	48	68	76	81	83	80	73	62	90-4-7.5	69	90	97	102	105	101	94	83
56-4-1.5	57	68	78	84	85	80	69	65	100-4-10	73	93	101	106	108	105	98	87
63-4-1.5	51	71	79	84	86	83	76	65	100-4-15	74	94	102	107	109	106	99	88

Dimensions mm

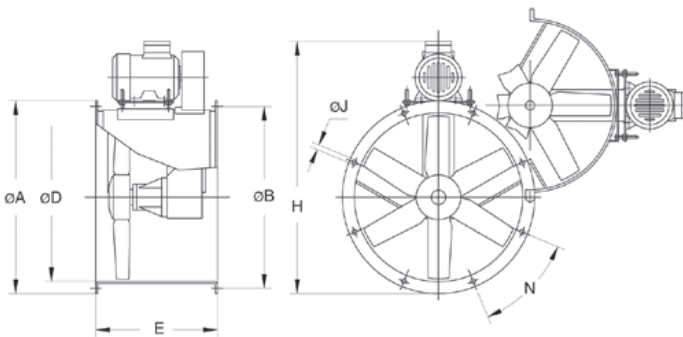

Model	ØA	ØB	ØD	E	H	ØJ	N
HPX-35-2T-0.75	425	395	355	380	606	10	8x45°
HPX-35-4T-0.33	425	395	355	380	609	10	8x45°
HPX-45-4T-0.33	540	500	460	420	740	12	8x45°
HPX-45-4T-0.50	540	500	460	420	728	12	8x45°
HPX-50-4T-0.75	600	560	512	420	803	12	12x30°
HPX-50-4T-1	600	560	512	420	803	12	12x30°
HPX-56-4T-0.75	660	620	560	450	848	12	12x30°
HPX-56-4T-1	660	620	560	450	848	12	12x30°
HPX-56-4T-1.5	660	620	560	450	870	12	12x30°
HPX-63-4T-1.5	730	690	640	500	950	12	12x30°
HPX-63-4T-2	730	690	640	500	950	12	12x30°
HPX-71-4T-1.5	810	770	710	550	1017	12	16x22°30'
HPX-71-4T-2	810	770	710	550	1017	12	16x22°30'
HPX-71-4T-3	810	770	710	550	1035	12	16x22°30'
HPX-80-4T-4	900	860	800	600	1173	12	16x22°30'
HPX-80-4T-5.5	900	860	800	600	1200	12	16x22°30'
HPX-90-4T-5.5	1015	970	900	650	1320	15	16x22°30'
HPX-90-4T-7.5	1015	970	900	650	1320	15	16x22°30'
HPX-100-4T-10	1115	1070	1000	750	1483	15	16x22°30'
HPX-100-4T-15	1115	1070	1000	750	1513	15	16x22°30'

Characteristic curves

Q= Flow rate in m³/h, m³/s and cfm.

Pe= Static pressure in mm H₂O, Pa and inwg.

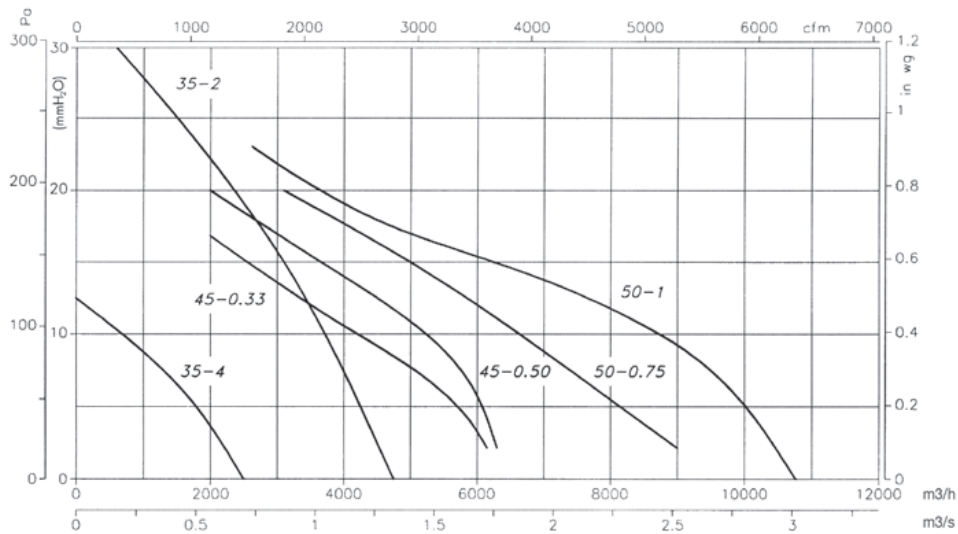

Characteristic curves

Q= Flow rate in m³/h, m³/s and cfm.

Pe= Static pressure in mm H₂O, Pa and inwg.

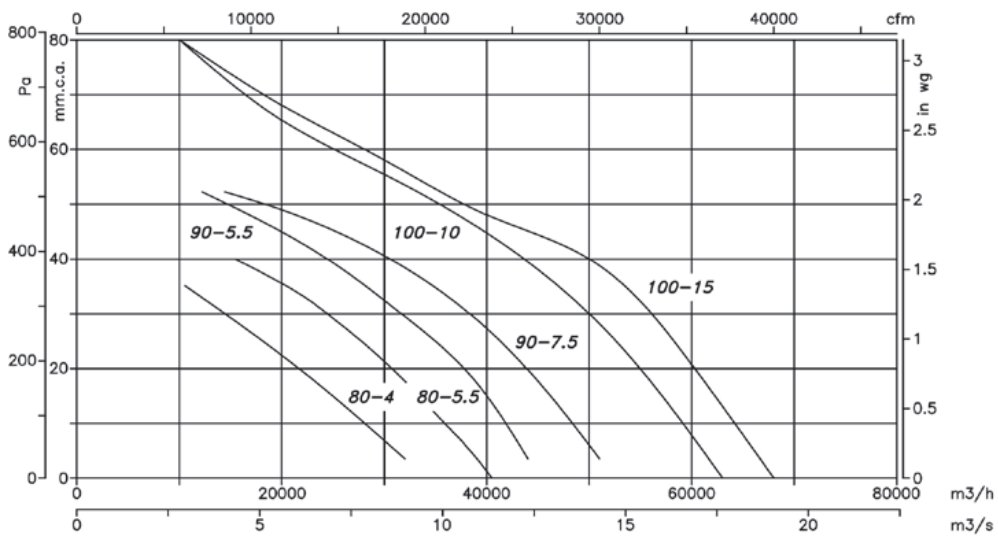
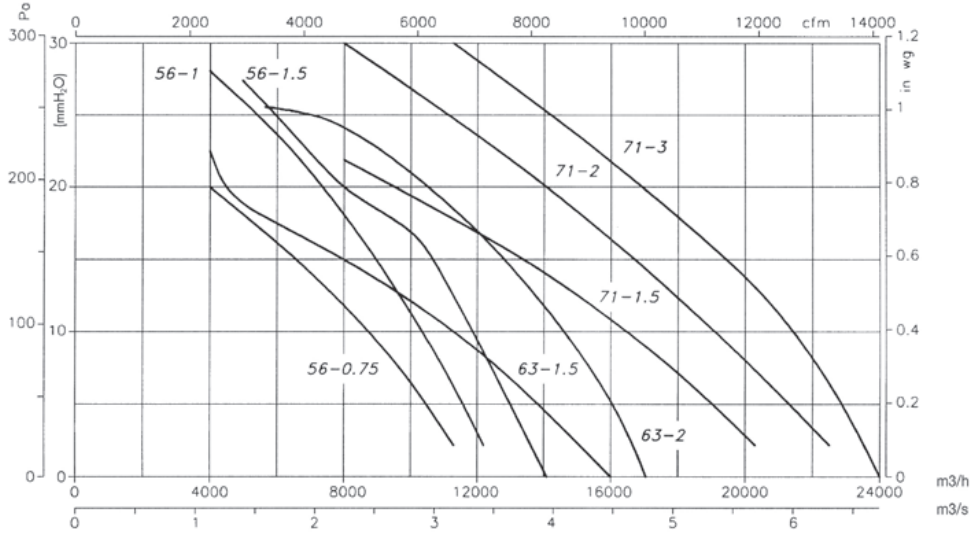

Accessories

See accessories section.



INT

VSD3/A-RFT
VSD1/A-RFM

ELECTRIC
CONTROL
PANELS

RT

BTUB

BAC

PS

S

SI

HBA



Forked tubular axial fans with motors outside the air flow



Forked tubular fans for transferring air up to 150°C in continuous operation and up to 200°C in sporadic mode.

Fan:

- Sheet steel tubular casing.
- Cast aluminium impeller.
- Impeller to motor airflow direction.

Motor:

- IE3 efficiency motors for powers equal to or higher than 0.75kW except single-phase, 2-speed and 8-pole.
- Class F motors with ball bearings and IP55 protection.
- Three-phase 230/400V-50Hz (up to 4kW)

and 400/690V-50Hz (powers higher than 4kW).

- Operating temperature: -25°C + 150°C

Finish:

- Anti-corrosive finish of polyester resin polymerised at 190°C, previously degreased with phosphate-free nanotechnological treatment.

On request:

- Stainless steel casing.
- Hot dip galvanised finish.
- Special windings for different voltages and motors with PTC thermistors.

Order code



HBA: Forked tubular axial fans with motors outside the air flow.

Impeller diameter in cm

Number of motor poles
4=1400 r/min. 50 Hz

T= Three-phase

Technical characteristics

Model	Speed (r/min)	Max. admissible current (A)		Installed power (kW)	Maximum flow rate (m³/h)	Sound pressure level dB(A)	Approx. weight (kg)
		230V	400V				
HBA-31-2T	2760	2.57	1.49	0.55	2900	77	25
HBA-31-2M	2810	3.49		0.55	2900	77	26
HBA-31-4T	1350	1.66	0.96	0.25	1600	66	24
HBA-31-4M	1370	2.00		0.25	1600	66	25
HBA-40-2T IE3	2830	4.03	2.34	1.10	6200	82	46
HBA-40-2M	2820	6.51		1.10	6200	82	46
HBA-40-4T	1370	2.02	1.17	0.37	3200	75	40
HBA-45-2T IE3	2910	10.00	5.77	3.00	8550	84	61
HBA-50-4T IE3	1420	2.82	1.62	0.75	6750	76	74
HBA-63-4T IE3	1455	4.07	2.34	1.10	11150	77	95
HBA-71-4T IE3	1450	13.90	8.00	4.00	15850	79	166
HBA-71-6T	900	2.99	1.73	0.55	11200	74	140
HBA-80-6T IE3	945	4.68	2.69	1.10	14900	77	196
HBA-100-6T IE3	945	4.68	2.69	1.10	21700	80	266

Accessories

See accessories section.



Dimensions mm

HBA-31...50

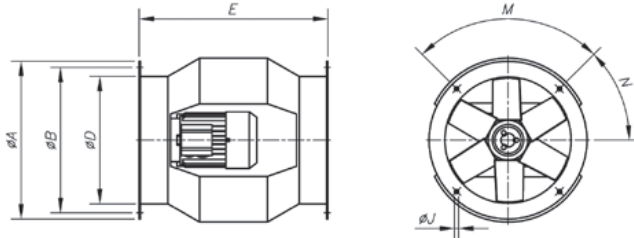

HBA-63...100

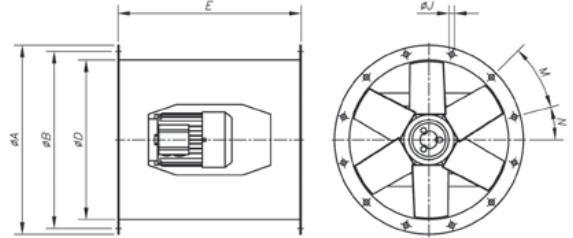

Model	ØA	ØB	ØD	E	ØJ	M	N
HBA-31	385	355	308	460	10	4x90°	45°
HBA-40	490	450	410	580	12	8x45°	22.5°
HBA-45	540	500	460	640	12	8x45°	22.5°
HBA-50	600	560	514	730	12	12x30°	15°
HBA-63	730	690	640	730	12	12x30°	15°
HBA-71	810	770	710	770	12	16x22.5°	11.25°
HBA-80	900	860	800	830	12	16x22.5°	11.25°
HBA-100	1115	1070	1000	1270	15	16x22.5°	11.25°

Characteristic curves

Q= Flow rate in m³/h, m³/s and cfm.

Pe= Static pressure in mm H₂O, Pa and inwg.

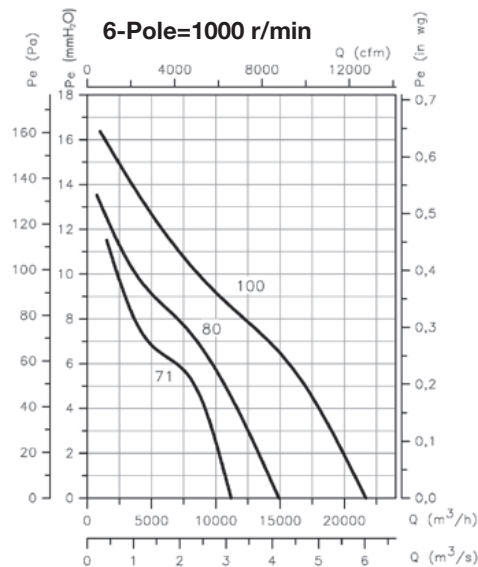
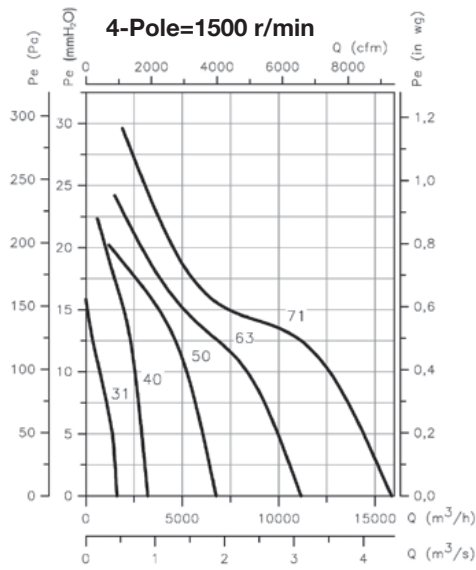
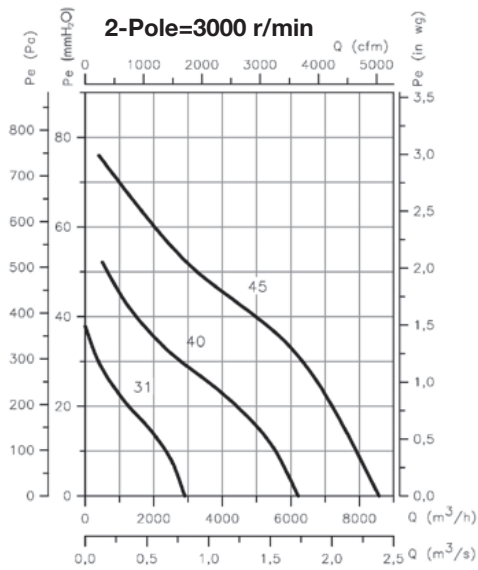

HPX/SEC



Fans designed with the best technology and experience to withstand extreme working conditions in kilns, drying barns and other applications with high temperatures and humidity



Fan:

- Large thickness, tubular sheet steel casing with rotating cover.
- Cast aluminium impellers.
- High quality ball bearings, greased for high temperatures
- Ball bearing support with greasers
- External greasers in fan casing.
- Airflow direction from motor to impeller.
- Maximum temperature of air to be carried: -25°C+120°C.

Motor:

- IE3 efficiency motors for powers equal to or higher than 0.75kW except single-phase, 2-speed and 8-pole.

- Class F motors with ball bearings and IP55 protection.
- Single-phase 230V-50Hz and three-phase 230/400V-50Hz (up to 4kW) and 400/690V-50Hz (powers higher than 4kW).

Finish:

- Heat-resistant anti-corrosive paint.

On request:

- Airflow direction from impeller to motor.
- 100% reversible impellers.
- Special windings for different voltages.
- Category 2 ATEX certification (HPX/ATEX series version).

Order code

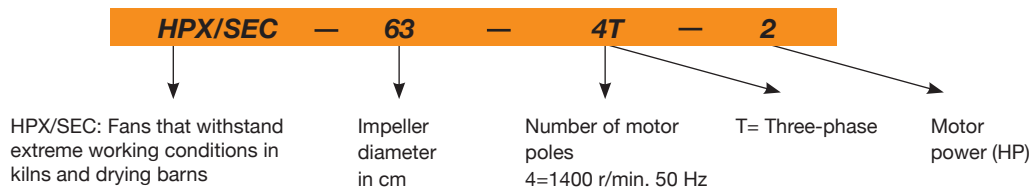

Technical characteristics

Model	Speed (r/min)	Max. admissible current (A)			Installed power (kW)	Blade inclination angle (°)	Maximum flow rate (m³/h)	Sound pressure level dB(A)	Approx. weight (kg)
		230V	400V	690V					
HPX/SEC-63-4T-1 IE3	1420	2.82	1.62		0.75	12	13800	73	61
HPX/SEC-63-4T-1.5 IE3	1455	4.07	2.34		1.10	20	17800	74	66
HPX/SEC-63-4T-2 IE3	1450	5.48	3.15		1.50	24	19300	75	69
HPX/SEC-63-4T-3 IE3	1435	7.93	4.56		2.20	30	21700	76	78
HPX/SEC-63-4T-4 IE3	1440	10.7	6.15		3.00	38	24250	77	84
HPX/SEC-71-4T-1.5 IE3	1455	4.07	2.34		1.10	10	18100	78	81
HPX/SEC-71-4T-2 IE3	1450	5.48	3.15		1.50	14	20900	79	85
HPX/SEC-71-4T-3 IE3	1435	7.93	4.56		2.20	22	25100	81	93
HPX/SEC-71-4T-4 IE3	1440	10.7	6.15		3.00	28	27500	82	99
HPX/SEC-80-4T-4 IE3	1440	10.7	6.15		3.00	14	27900	83	112
HPX/SEC-80-4T-5.5 IE3	1450	13.9	8		4.00	18	32750	84	118
HPX/SEC-90-4T-4 IE3	1440	10.7	6.15		3.00	8	33600	87	123
HPX/SEC-90-4T-5.5 IE3	1450	13.9	8		4.00	12	38900	89	129
HPX/SEC-90-4T-7.5 IE3	1465		10.3	5.97	5.50	16	44150	91	154
HPX/SEC-90-4T-10 IE3	1465		13.9	8.06	7.50	20	48600	92	163
HPX/SEC-100-4T-7.5 IE3	1465		10.3	5.97	5.50	10	46850	92	164
HPX/SEC-100-4T-10 IE3	1465		13.9	8.06	7.50	14	54900	93	173
HPX/SEC-100-4T-15 IE3	1470		21.4	12.4	11.00	20	63200	94	218
HPX/SEC-100-4T-20 IE3	1465		28.7	16.6	15.00	26	73200	95	220

Acoustic characteristics

The indicated values are determined by measuring the sound pressure level and sound power in dB(A) obtained in a free field at a distance equivalent to twice the size of the fan plus the impeller diameter, with a minimum of 1.5 m.

Noise power spectrum Lw(A) in dB(A) frequency band in [Hz]

Model	63	125	250	500	1000	2000	4000	8000	Model	63	125	250	500	1000	2000	4000	8000
63-4T-1 IE3	50	70	78	83	85	82	75	64	80-4T-5.5 IE3	56	76	84	89	91	88	81	70
63-4T-1.5 IE3	48	68	76	81	83	80	73	65	90-4T-4 IE3	61	82	89	94	97	93	86	79
63-4T-2 IE3	52	68	76	81	83	80	73	66	90-4T-5.5 IE3	60	81	88	93	96	92	85	74
63-4T-3 IE3	53	70	78	83	85	82	77	67	90-4T-7.5 IE3	59	80	87	92	95	91	84	73
63-4T-4 IE3	54	71	79	84	86	83	78	68	90-4T-10 IE3	58	79	86	91	94	90	83	72
71-4T-1.5 IE3	54	74	82	87	89	86	79	69	100-4T-7.5 IE3	64	84	92	97	99	96	89	78
71-4T-2 IE3	53	73	81	86	88	85	78	70	100-4T-10 IE3	62	82	90	95	97	94	87	76
71-4T-3 IE3	58	72	80	85	87	84	77	71	100-4T-15 IE3	61	81	89	94	96	93	86	75
71-4T-4 IE3	59	73	81	86	88	85	78	72	100-4T-20 IE3	63	83	91	96	98	95	88	77
80-4T-4 IE3	56	76	84	89	91	88	81	74									

Dimensions mm

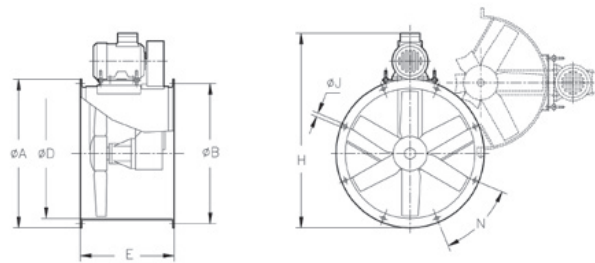

Model	ØA	ØB	ØD	E	H	ØJ	N
HPX/SEC-63-4T-1 IE3	730	690	640	500	915	12	12x30°
HPX/SEC-63-4T-1.5 IE3	730	690	640	500	943	12	12x30°
HPX/SEC-63-4T-2 IE3	730	690	640	500	943	12	12x30°
HPX/SEC-63-4T-3 IE3	730	690	640	500	963	12	12x30°
HPX/SEC-63-4T-4 IE3	730	690	640	500	963	12	12x30°
HPX/SEC-71-4T-1.5 IE3	810	770	710	550	1022	12	16x22°30'
HPX/SEC-71-4T-2 IE3	810	770	710	550	1022	12	16x22°30'
HPX/SEC-71-4T-3 IE3	810	770	710	550	1048	12	16x22°30'
HPX/SEC-71-4T-4 IE3	810	770	710	550	1048	12	16x22°30'
HPX/SEC-80-4T-4 IE3	900	860	800	600	1165	12	16x22°30'
HPX/SEC-80-4T-5.5 IE3	900	860	800	600	1186	12	16x22°30'
HPX/SEC-90-4T-4 IE3	1015	970	900	650	1255	15	16x22°30'
HPX/SEC-90-4T-5.5 IE3	1015	970	900	650	1292	15	16x22°30'
HPX/SEC-90-4T-7.5 IE3	1015	970	900	650	1338	15	16x22°30'
HPX/SEC-90-4T-10 IE3	1015	970	900	650	1338	15	16x22°30'
HPX/SEC-100-4T-7.5 IE3	1115	1070	1000	750	1453	15	16x22°30'
HPX/SEC-100-4T-10 IE3	1115	1070	1000	750	1453	15	16x22°30'
HPX/SEC-100-4T-15 IE3	1115	1070	1000	750	1525	15	16x22°30'
HPX/SEC-100-4T-20 IE3	1115	1070	1000	750	1525	15	16x22°30'

Accessories

See accessories section.



INT



VSD3/A-RFT
VSD1/A-RFM



ELECTRIC
CONTROL
PANELS



RT



BTUB



BAC



PS



S



SI

Characteristic curves

Q= Flow rate in m³/h, m³/s and cfm.

Pe= Static pressure in mm H₂O, Pa and inwg.

Impeller diameter (cm): 63

Number of blades: 6

Number of poles: 4

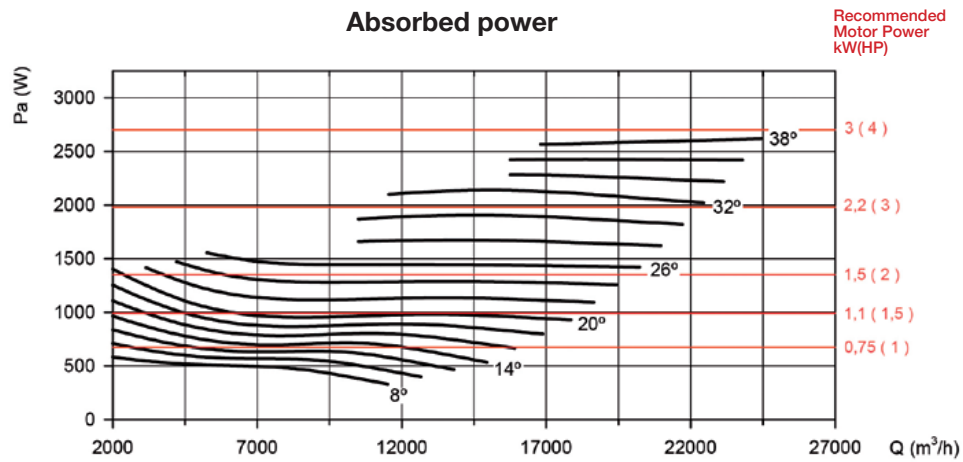
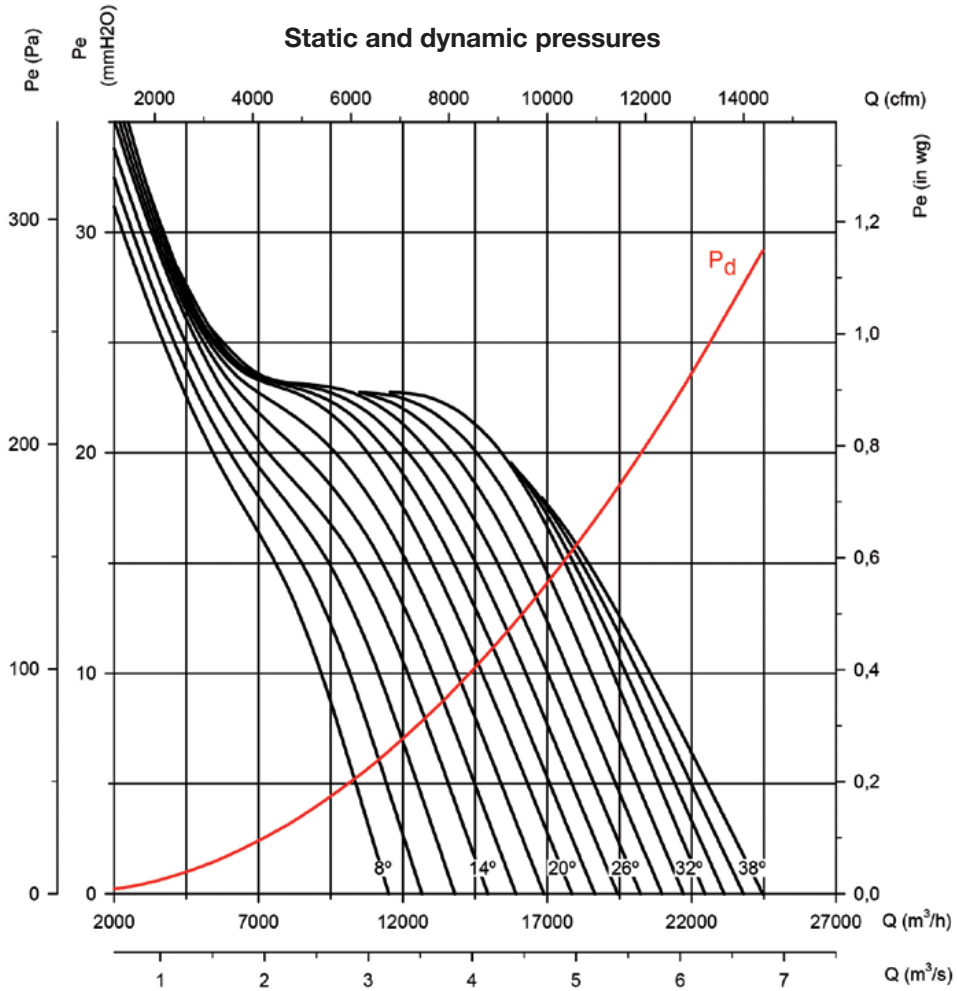

Characteristic curves

Q= Flow rate in m³/h, m³/s and cfm.

Pe= Static pressure in mm H₂O, Pa and inwg.

Impeller diameter (cm): 71

Number of blades: 6

Number of poles: 4

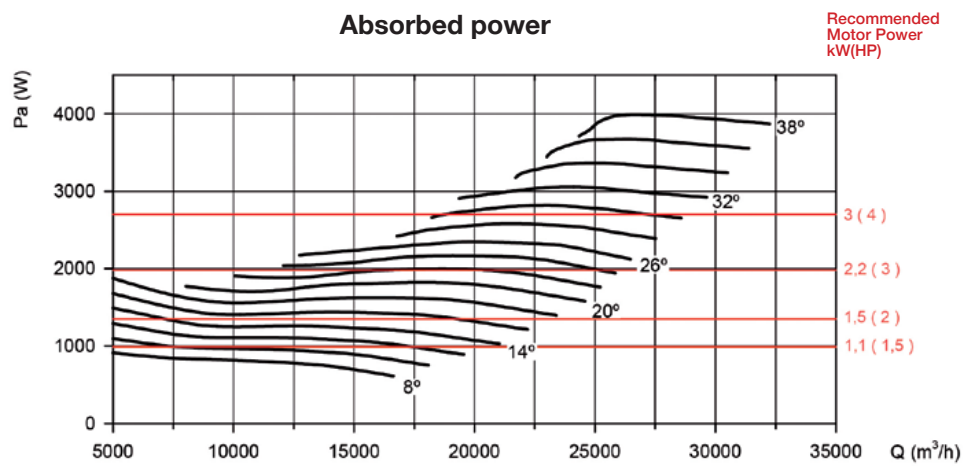
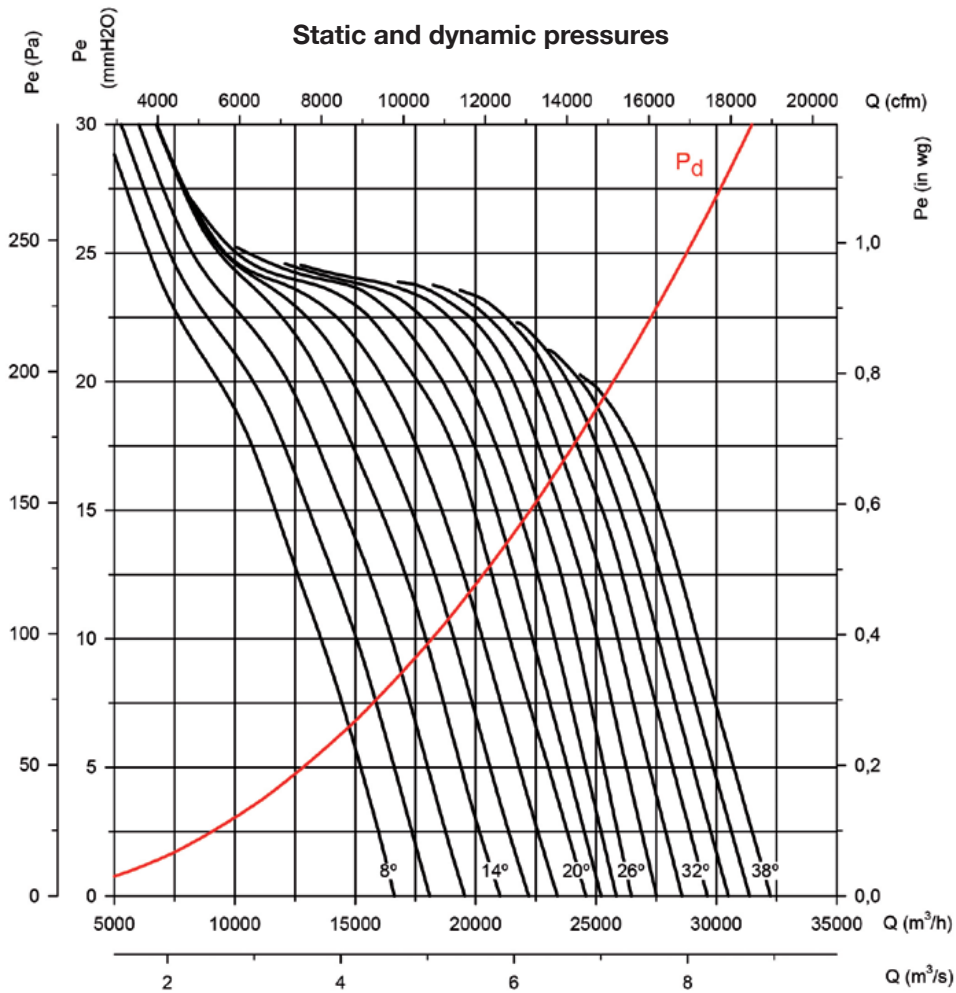

Characteristic curves

Q= Flow rate in m³/h, m³/s and cfm.

Pe= Static pressure in mm H₂O, Pa and inwg.

Impeller diameter (cm): 80

Number of blades: 6

Number of poles: 4

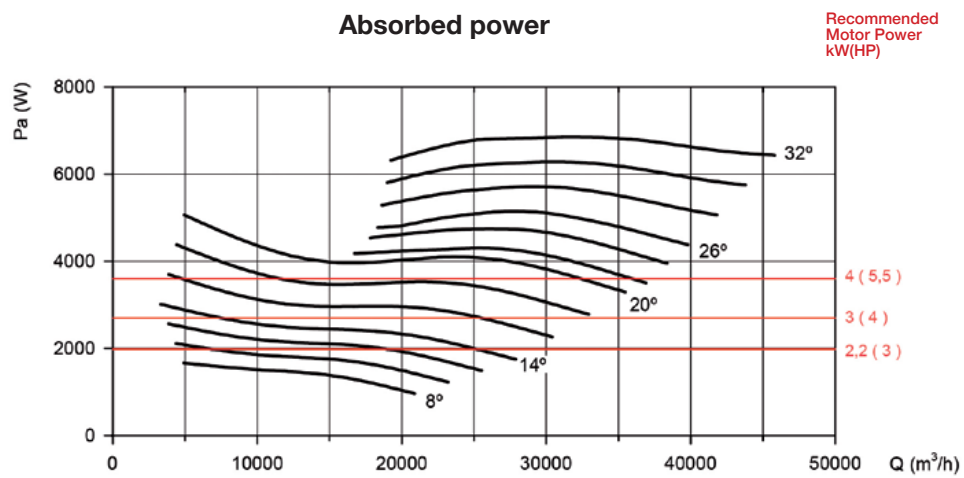
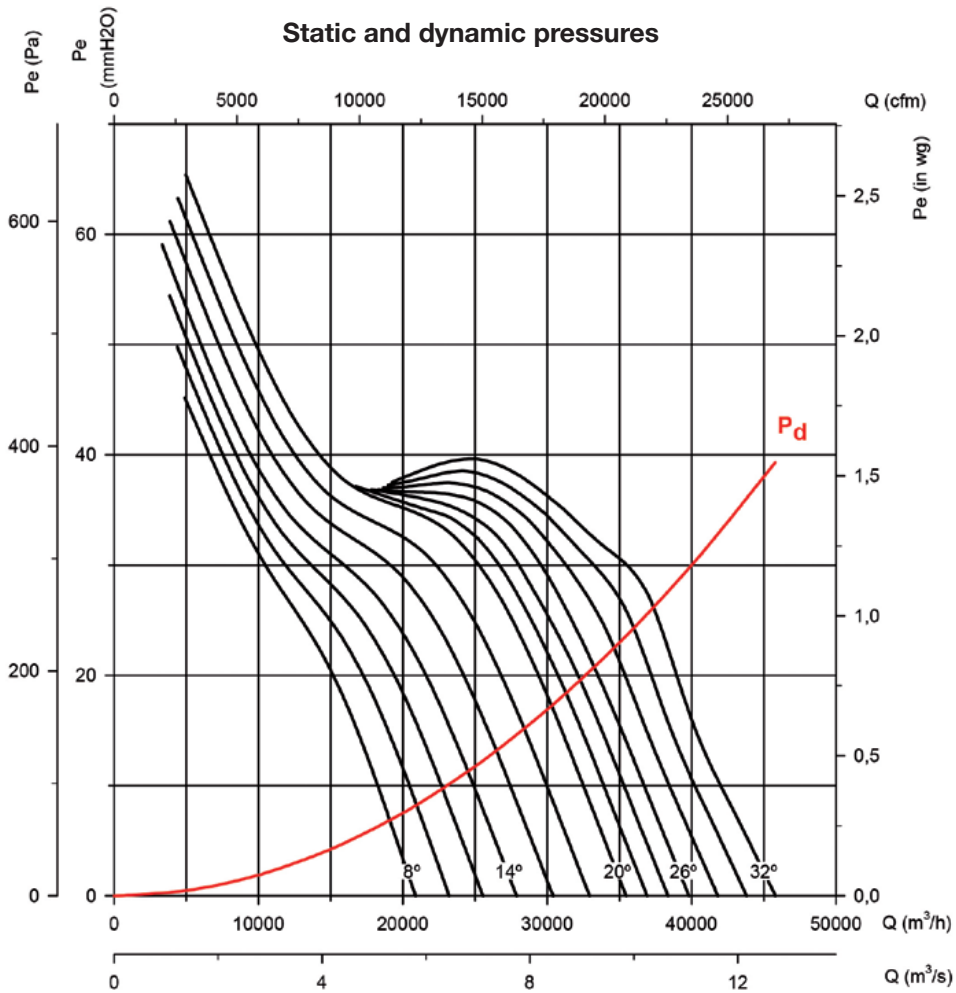

Characteristic curves

Q= Flow rate in m³/h, m³/s and cfm.

Pe= Static pressure in mm H₂O, Pa and inwg.

Impeller diameter (cm): 90

Number of blades: 6

Number of poles: 4

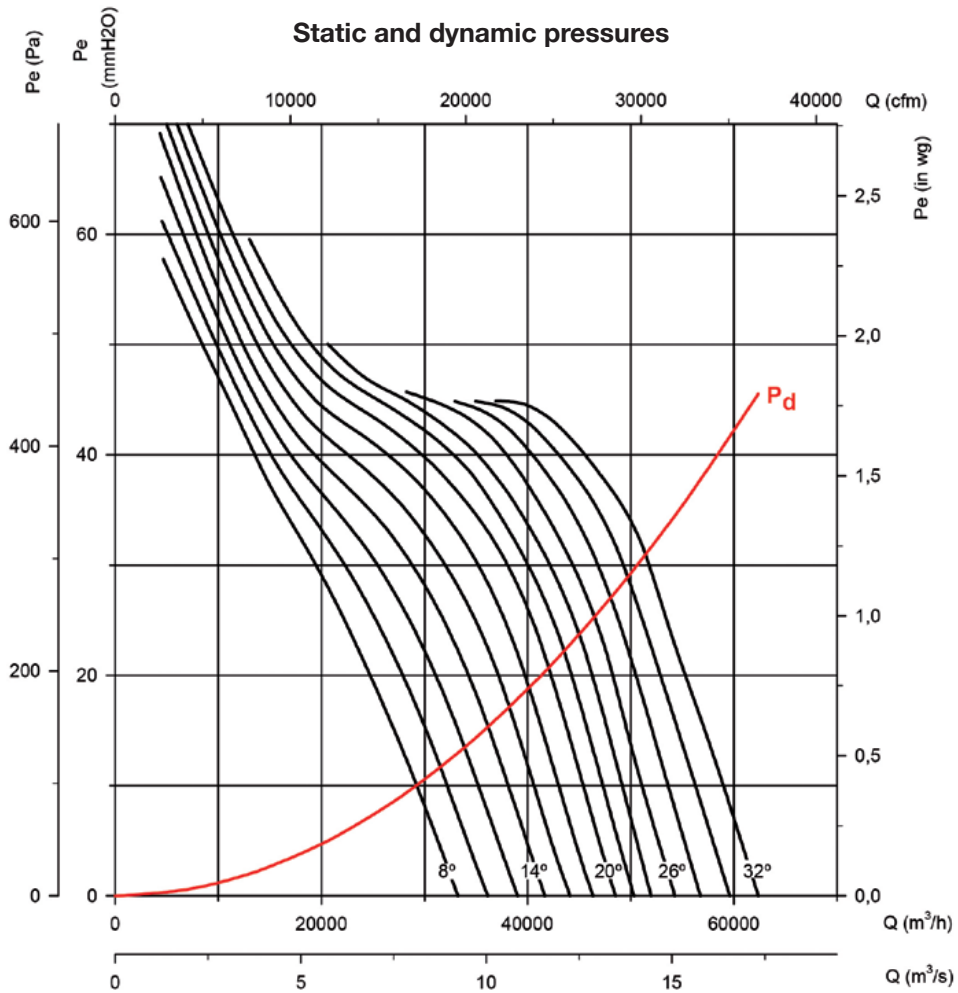

Absorbed power

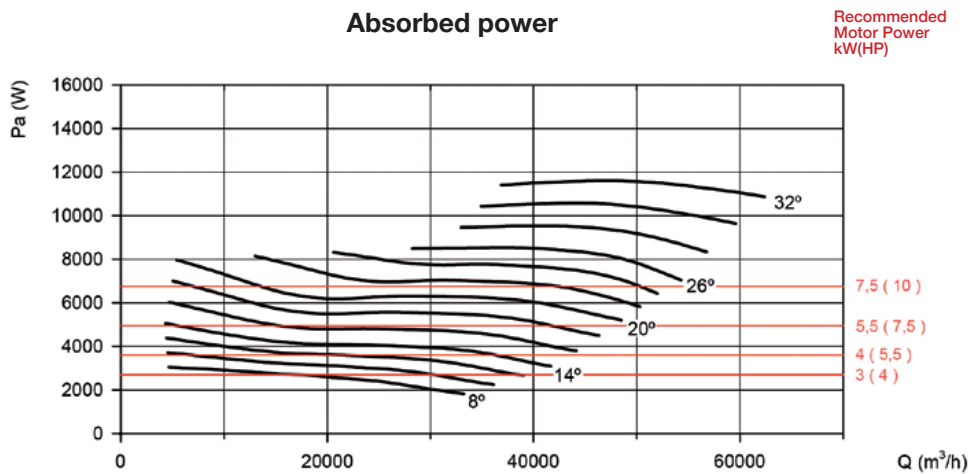

Characteristic curves

Q= Flow rate in m³/h, m³/s and cfm.

Pe= Static pressure in mm H₂O, Pa and inwg.

Impeller diameter (cm): 100

Number of blades: 6

Number of poles: 4

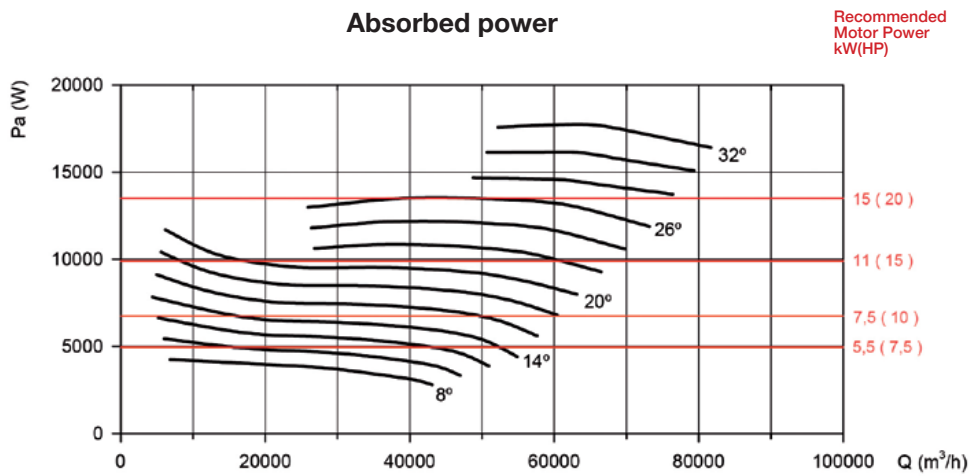
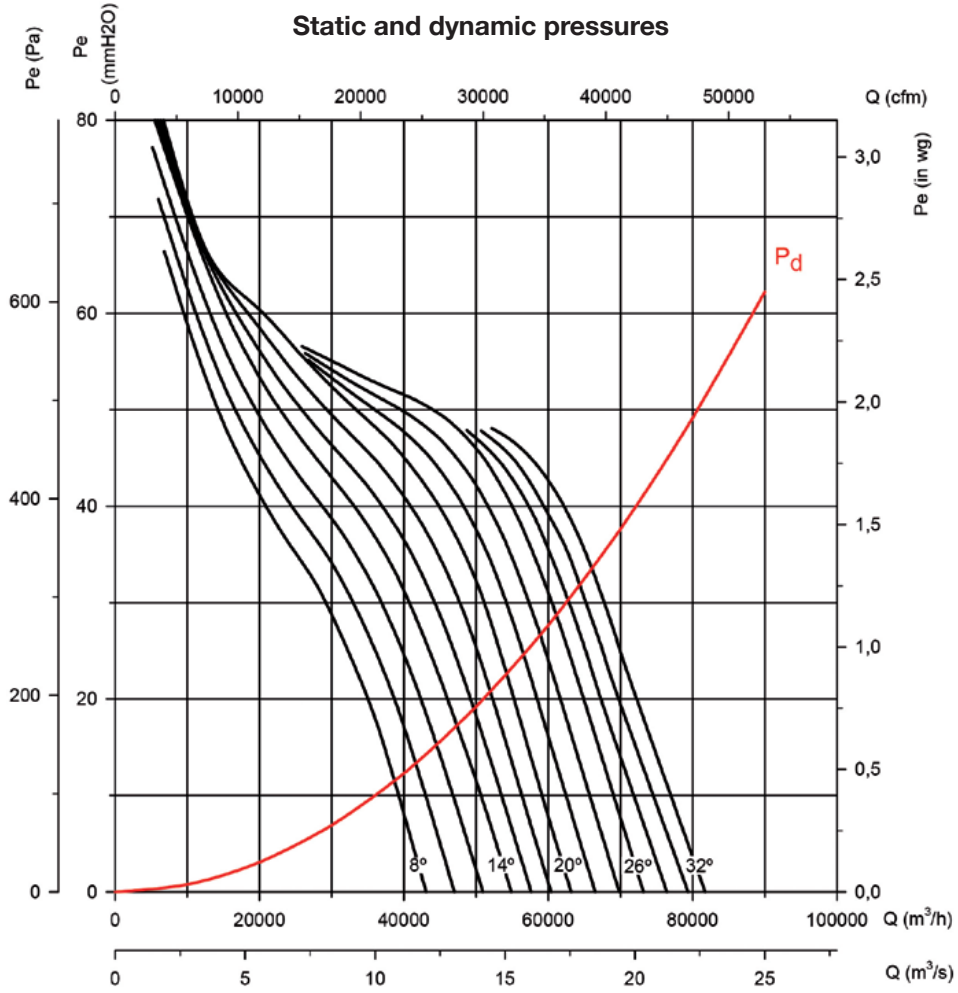

HCH/SEC

Fans designed with the best technology and experience to withstand extreme working conditions in ceramic and wood drying kilns



Fan:

- Support ring made of sheet steel or AISI-304 stainless steel, depending on version.
- Cast aluminium impeller.
- Airflow direction from motor to impeller.

Motor version 90°C 100% RH:

- Class H motors with ball bearings specially designed for high temperatures, IP55 protection.
- Motors with external ventilation.
- Three-phase 230/400V-50Hz (up to 3kW) and 400/690V-50Hz (powers higher than 3kW).
- Operating temperature: -10°C +90°C y 100% relative humidity.

Finish:

- Anti-corrosive finish of polyester resin polymerised at 190°C, previously degreased with phosphate-free nanotechnological treatment.
- Stainless steel with shot peen finish version.

On request:

- Any HCH series model can be converted to HCH/SEC.
- Airflow direction from impeller to motor.
- 100% reversible impellers.
- Special windings for different voltages.
- Support ring made of AISI-316 stainless steel.

Order code

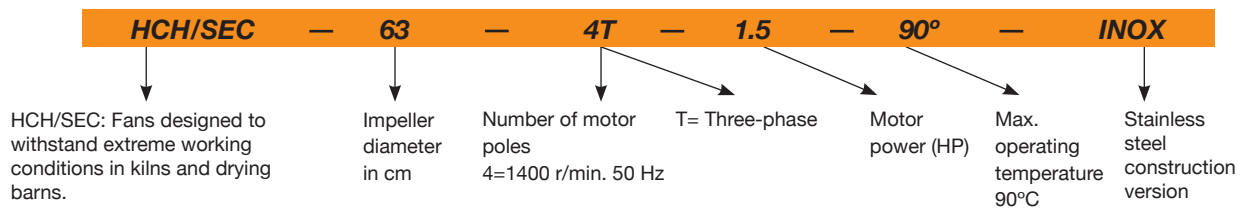

Technical characteristics

Model	Speed (r/min)	Max. admissible current (A)		Installed power (kW)	Maximum flow rate (m³/h)	Sound pressure level dB(A)	Approx. weight (kg)
		230V	400V				
HCH/SEC-63-4T-1.5	1450	5.2	3	1.1	17000	74	39
HCH/SEC-63-4T-2	1450	6.41	3.7	1.5	18900	75	42
HCH/SEC-63-4T-3	1450	8.49	4.9	2.2	22100	76	50
HCH/SEC-63-4T-4	1450	11.78	6.8	3	25400	77	52
HCH/SEC-71-4T-1.5	1450	5.2	3	1.1	19750	78	45
HCH/SEC-71-4T-2	1450	6.41	3.7	1.5	21100	79	47
HCH/SEC-71-4T-3	1450	8.49	4.9	2.2	23950	81	56
HCH/SEC-71-4T-4	1450	11.78	6.8	3	29400	82	58
HCH/SEC-80-4T-3	1450	8.49	4.9	2.2	28000	82	73
HCH/SEC-80-4T-4	1450	11.78	6.8	3	32700	83	75
HCH/SEC-80-4T-5.5	1450	15.24	8.8	4	37200	84	80

Acoustic characteristics

The indicated values are determined by measuring the sound pressure level and sound power in dB(A) obtained in a free field at a distance equivalent to twice the size of the fan plus the impeller diameter, with a minimum of 1.5 m.

Noise power spectrum Lw(A) in dB(A) frequency band in [Hz]

Model	63	125	250	500	1000	2000	4000	8000	Model	63	125	250	500	1000	2000	4000	8000
HCH/SEC-63-4T-1.5	51	71	79	84	86	83	76	65	HCH/SEC-71-4T-3	58	78	86	91	93	90	83	72
HCH/SEC-63-4T-2	52	72	80	85	87	84	77	66	HCH/SEC-71-4T-4	59	79	87	92	94	91	84	73
HCH/SEC-63-4T-3	53	73	81	86	88	85	78	67	HCH/SEC-80-4T-3	59	79	87	92	94	91	84	73
HCH/SEC-63-4T-4	54	74	82	87	89	86	79	68	HCH/SEC-80-4T-4	60	80	88	93	95	92	85	74
HCH/SEC-71-4T-1.5	55	75	83	88	90	87	80	69	HCH/SEC-80-4T-5.5	61	81	89	94	96	93	86	75
HCH/SEC-71-4T-2	56	76	84	89	91	88	81	70									

Dimensions mm

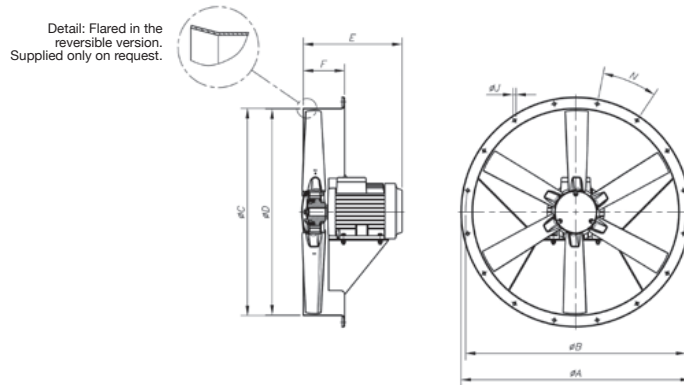

Model	ØA	ØB	ØC	ØD	E					F	ØJ	N
					1.5	2	3	4	5			
HCH/SEC-63-4	730	690	645	640	305	330	360	360	-	150	12	12 X 30°
HCH/SEC-71-4	810	770	715	710	302	322	367	367	-	150	12	16 X 22°30'
HCH/SEC-80-4	900	860	805	800	-	-	375	375	390	180	12	16 X 22°30'

Characteristic curves

See HCH series curves

Accessories

See accessories section.



HGI



Axial fans with large diameters for farms



Wall-mounted axial fans designed for large airflows at low speed with automatic opening blind.

Fan:

- Sheet steel support frame.
- Galvanised steel structure.
- Galvanised sheet steel impeller.
- Anti-contact protective grille pursuant to standard UNE-EN ISO 12499.
- Specially designed for use in farms and greenhouses.
- Airflow direction from motor to impeller.

Motor:

- IE3 efficiency motors for powers equal to or higher than 0.75kW except single-phase, 2-speed and 8-pole.

- Class F motors with ball bearings and IP55 protection.
- Three-phase 230/400V-50Hz.
- Operating temperature: -25°C+ 50°C.

Finish:

- Anti-corrosive finish on galvanised sheet steel.

On request:

- Without blind and with protective grille on the impulsion side.
- Special windings for different voltages.

Order code

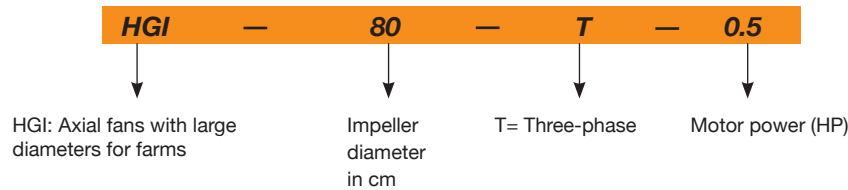

Technical characteristics

Model	Speed (r/min)	Max. admissible current (A)		Installed power (kW)	Maximum flow rate (m ³ /h)	Sound pressure level dB(A)	Approx. weight (kg)
		230V	400V				
HGI-80-T-0.5	570	1.70	1.00	0.37	16000	63	48
HGI-80-T-0.75	630	2.40	1.40	0.55	18000	65	49
HGI-100-T-0.5	398	2.10	1.20	0.37	25000	62	63
HGI-100-T-0.75	472	2.80	1.60	0.55	29000	65	64
HGI-100-T-1 IE3	503	2.82	1.62	0.75	32000	66	81
HGI-125-T-1 IE3	437	2.82	1.62	0.75	38000	69	102
HGI-125-T-1.5 IE3	485	4.07	2.34	1.10	43000	72	110

Acoustic characteristics

The indicated values are determined by measuring the sound pressure level and sound power in dB(A) obtained in a free field at a distance equivalent to twice the size of the fan plus the impeller diameter, with a minimum of 1.5 m.

Noise power spectrum Lw(A) in dB(A) frequency band in [Hz]

Model	63	125	250	500	1000	2000	4000	8000	Model	63	125	250	500	1000	2000	4000	8000
HGI-80-T-0.5	57	64	72	74	72	69	66	58	HGI-100-T-1	61	69	77	79	77	74	70	63
HGI-80-T-0.75	59	66	74	76	74	71	68	60	HGI-125-T-1	64	72	80	82	80	77	73	66
HGI-100-T-0.5	57	65	73	75	73	70	66	59	HGI-125-T-1.5	67	75	83	85	83	80	76	69
HGI-100-T-0.75	60	68	76	78	76	73	69	62									

Characteristic curves

Q= Flow rate in m³/h, m³/s and cfm.

Pe= Static pressure in mm H₂O, Pa and inwg.

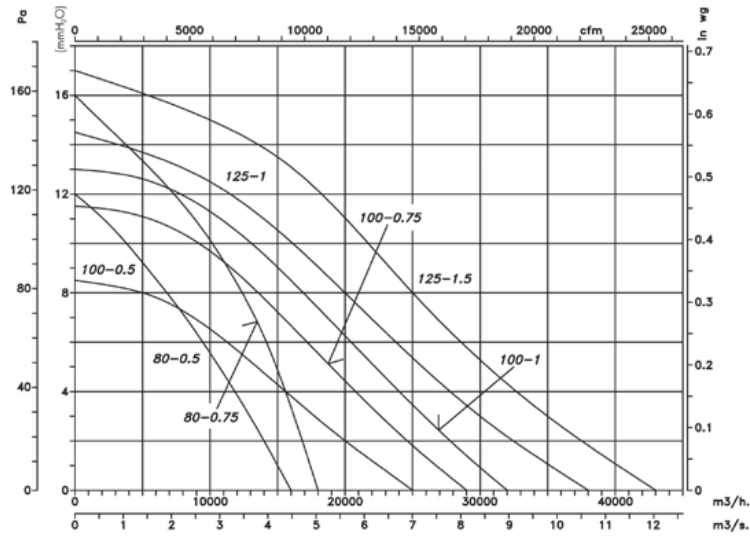

Dimensions mm

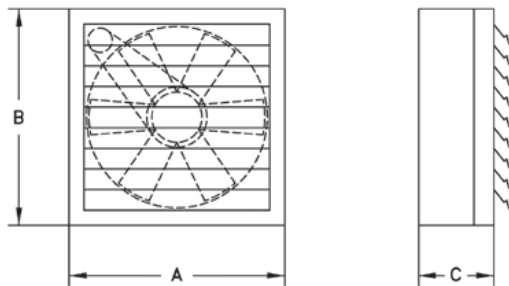

Model	A	B	C
HGI-80	925	925	427
HGI-100	1125	1125	447
HGI-125	1375	1375	480

Accessories

See accessories section.



INT



VSD3/A-RFT
VSD1/A-RFM



ELECTRIC
CONTROL
PANELS



SI

HT

Roof-mounted axial extract fans with flat bases



HT 25...63

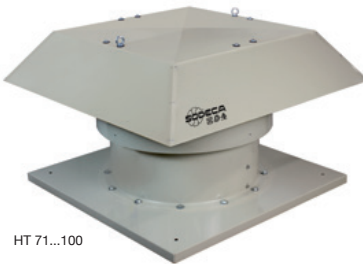

HT 71...100

Roof-mounted axial extract fans with fibreglass reinforced plastic impellers and flat bases for installing on roof.

Fan:

- Painted, galvanised sheet steel support base.
- Fibreglass reinforced polyamide-6 impellers, except for 100 models, which have 4 poles in aluminium.
- Bird guard.
- Rain cap made of painted galvanised sheet steel, with protection against corrosion.
- Airflow direction from motor to impeller.

Motor:

- IE3 efficiency motors for powers equal to or higher than 0.75kW except single-phase, 2-speed and 8-pole.
- Class F motors with ball bearings, IP55 protection, except single-phase models from size 45 to size 63, IP54 protection.

- Single-phase 220-240V-50Hz and three-phase 220-240V/380-415V-50Hz (up to 4kW) and 400/690V-50Hz (powers higher than 4kW).
- Maximum temperature of air to be carried: -25°C +60°C.

Finish:

- Anti-corrosive finish of polyester resin polymerised at 190°C, previously degreased with phosphate-free nanotechnological treatment.

On request:

- Option of supply in the form of IMPULSION FANS.
- Impellers made of cast aluminium.
- Special windings for different voltages
- ATEX-certified Category 2.



Order code

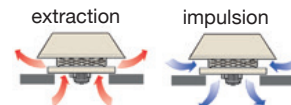
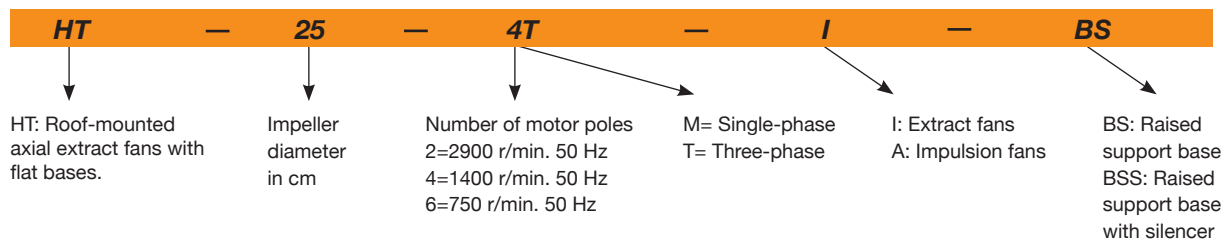

Technical characteristics

Model	Speed (r/min)	Maximum admissible current (A)			Installed power (kW)	Maximum flow rate (m³/h)	Sound pressure level dB(A)		Approx. weight (kg)	According to ErP
		230 V	400 V	690 V			Inlet	Exhaust		
HT-25-4T	1320	0.65	0.38		0.09	1080	41	40	16.2	*
HT-25-4M	1380	0.65			0.10	1080	41	40	16.2	*
HT-31-4T	1320	0.65	0.38		0.09	1800	47	46	19	2016
HT-31-4M	1370	0.83			0.09	1800	47	46	19	2016
HT-35-4T	1320	0.65	0.38		0.09	2600	48	47	25	2018
HT-35-4M	1370	0.83			0.09	2600	48	47	25	2018
HT-40-4T	1350	1.66	0.96		0.25	4600	51	50	28.6	2016
HT-40-4M	1370	2.00			0.25	4600	51	50	28.6	2016
HT-45-4T	1370	2.02	1.17		0.37	6500	55	53	50	2016
HT-45-4M	1400	2.76			0.37	6500	55	54	50	2016
HT-50-4T	1380	2.92	1.69		0.55	8500	59	57	62	2016
HT-50-4M	1350	4.40			0.55	8500	59	57	62	2016
HT-56-4T IE3	1420	2.82	1.62		0.75	9800	61	57	63	2016
HT-56-6T	900	1.51	0.87		0.25	6600	48	46	63	2018
HT-63-4T IE3	1455	4.07	2.34		1.10	14000	63	59	94	2018
HT-63-6T	900	2.24	1.30		0.37	9200	52	49	94	2018

Technical characteristics

Model	Speed (r/min)	Maximum admissible current (A)			Installed power (kW)	Maximum flow rate (m³/h)	Sound pressure level dB(A)		Approx. weight (kg)	According to ErP
		230 V	400 V	690 V			Inlet	Exhaust		
HT-71-4T IE3	1440	5.41	3.11		1.50	18000	69	67	109	2018
HT-71-6T	900	2.99	1.73		0.55	12200	58	56	96	2016
HT-80-4T IE3	1435	7.93	4.56		2.20	26200	73	70	163	2018
HT-80-6T IE3	945	4.68	2.69		1.10	18000	64	61	145	2018
HT-90-4T IE3	1440	10.70	6.15		3.00	31500	77	74	208	2016
HT-90-6T IE3	950	6.43	3.70		1.50	21200	68	65	205	2016
HT-100-4T-7.5 IE3	1465		10.30	5.97	5.50	37000	80	77	265	2016
HT-100-4T-10 IE3	1465		13.90	8.06	7.50	44000	84	81	269	2016
HT-100-6T-2 IE3	950	6.43	3.70		1.50	25000	71	68	220	2016
HT-100-6T-3 IE3	950	9.08	5.22		2.20	28200	75	72	231	2016

* Equipment not covered by Directive 2009/125/EC



Erp. (Energy Related Products)

Information on Directive 2009/125/EC can be downloaded from the SODECA website or the QuickFan selector programme.

Acoustic characteristics

The indicated values are determined by measuring the pressure and sound power levels in dB(A) obtained in a free field at a distance of 6 m.

Noise power spectrum Lw(A) in dB(A) frequency band in [Hz]

Values measured at inlet values with maximum flow rate (Qmax)

Model	63	125	250	500	1000	2000	4000	8000
25	27	37	54	54	62	58	51	42
31	33	43	60	60	68	64	57	48
35	34	44	61	61	69	65	58	49
40	28	45	57	65	70	70	66	59
45	32	49	61	69	74	74	70	63
50	36	53	65	73	78	78	74	67
56-4	38	55	67	75	80	80	76	69
56-6	25	42	54	62	67	67	63	56
63-4	40	57	69	77	82	82	78	71
63-6	29	46	58	66	71	71	67	60
71-4	46	63	75	83	88	88	84	77
71-6	35	52	64	72	77	77	73	66
80-4	57	78	85	90	93	89	82	71
80-6	48	69	76	81	84	80	73	62
90-4	61	82	89	94	97	93	86	75
90-6	52	73	80	85	88	84	77	66
100-4-7.5	64	85	92	97	100	96	89	78
100-4-10	68	89	96	101	104	100	93	82
100-6-2	55	76	83	88	91	87	80	69
100-6-3	59	80	87	92	95	91	84	73

Values measured at exhaust with maximum flow rate (Qmax)

Model	63	125	250	500	1000	2000	4000	8000
25	26	36	53	53	61	57	50	41
31	32	42	59	59	67	63	56	47
35	33	43	60	60	68	64	57	48
40	27	44	56	64	69	69	65	58
45	30	47	59	67	72	72	68	61
50	34	51	63	71	76	76	72	65
56-4	34	51	63	71	76	76	72	65
56-6	23	40	52	60	65	65	61	54
63-4	36	53	65	73	78	78	74	67
63-6	26	43	55	63	68	68	64	57
71-4	44	61	73	81	86	86	82	75
71-6	33	50	62	70	75	75	71	64
80-4	54	75	82	87	90	86	79	68
80-6	45	66	73	78	81	77	70	59
90-4	58	79	86	91	94	90	83	72
90-6	49	70	77	82	85	81	74	63
100-4-7.5	61	82	89	94	97	93	86	75
100-4-10	65	86	93	98	101	97	90	79
100-6-2	52	73	80	85	88	84	77	66
100-6-3	56	77	84	89	92	88	81	70

Dimensions mm

Model	A	B	C	D	F	G	H	I
HT-25	223	140	43	40	635	450	360	12
HT-31	245	140	65	40	635	500	410	12
HT-35	270	169	61	40	808	560	450	12
HT-40	295	169	86	40	808	630	530	12
HT-45	342	202	90	50	923	710	590	12
HT-50	373	238	85	50	1154	800	680	12
HT-56	402	238	124	40	1154	900	750	14
HT-63	457	277	141	40	1384	1000	850	14
HT-71	760	195	525	40	1120	1000	850	14
HT-80	790	215	525	50	1252	1150	1000	14
HT-90	910	232	638	40	1380	1150	1000	14
HT-100	1055	252	753	50	1527	1250	1100	14

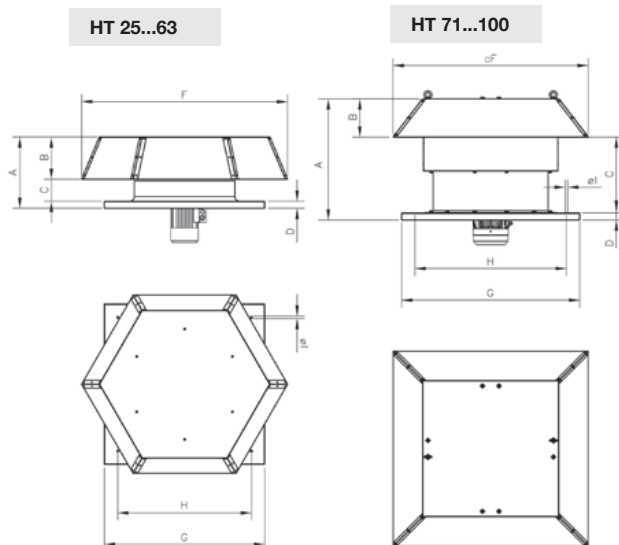

Characteristic curves

Q= Flow rate in m³/h, m³/s and cfm.

Pe= Static pressure in mm H₂O, Pa and inwg.

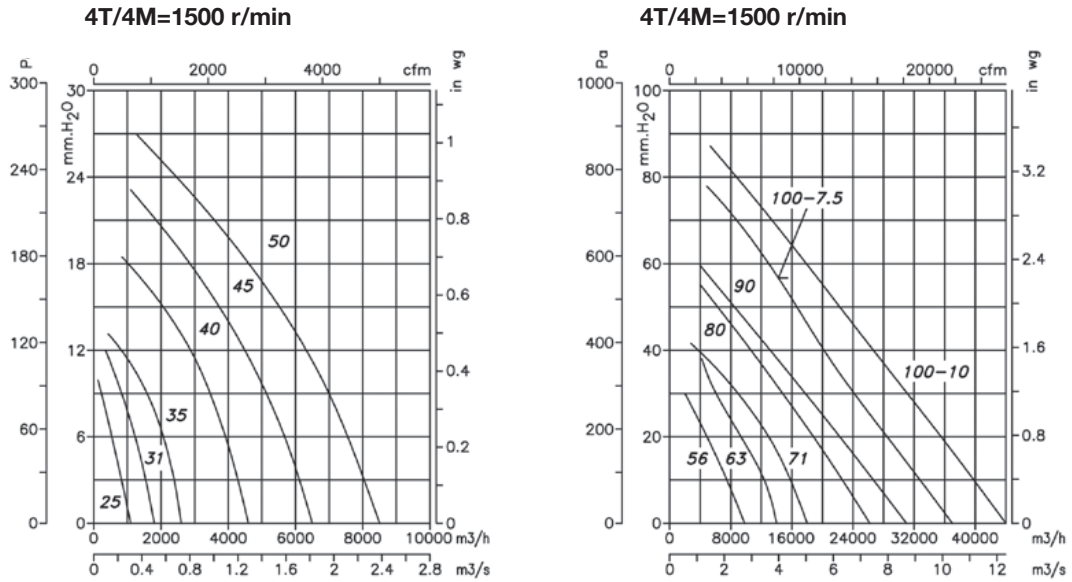

6T/6M=1000 r/min

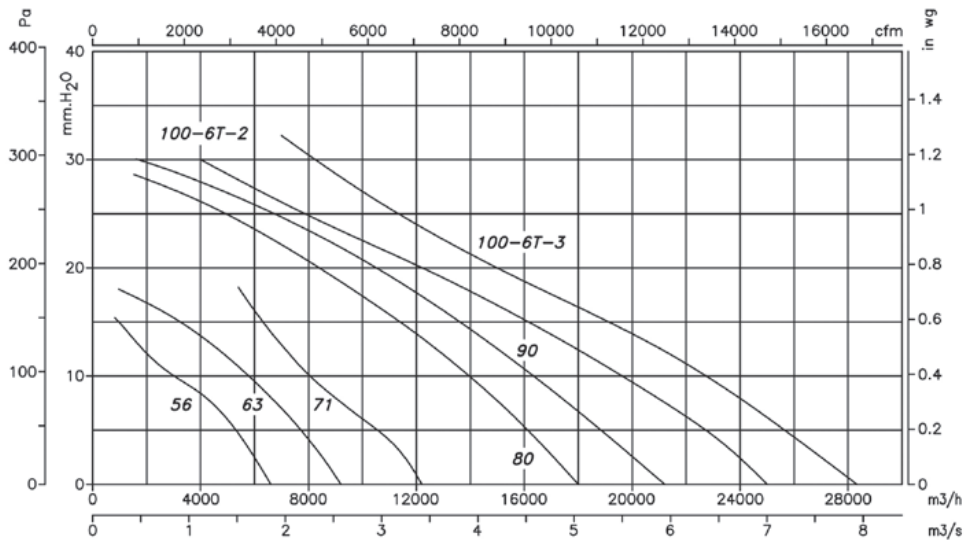

Accessories



HTMH



Roof-mounted multifunctional extract fans for large flow rates

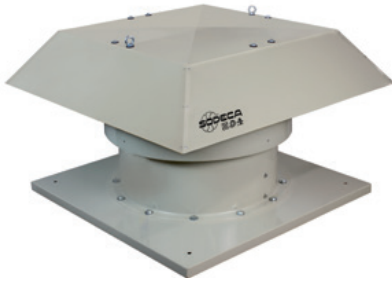

Roof-mounted multifunctional extract fans with robust structures for extraction operations with large flow rates.

Fan:

- Painted, galvanised sheet steel support base.
- Cast aluminium orientable impellers.
- Anti-contact protective grille pursuant to standard UNE-EN ISO 12499.
- Painted, galvanised sheet steel rain cover, with natural air outlet.

Motor:

- IE3 efficiency motors for powers equal to or higher than 0.75kW except single-phase, 2-speed and 8-pole.
- Class F motors with ball bearings, IP55 protection and with 1 or 2 speeds, depending on model.
- Three-phase 230/400V-50Hz (up to 4 kW) and 400/690V-50Hz (powers higher than 4 kW).

- Operating temperature: -25°C + 50°C.

Finish:

- Anti-corrosive finish of polyester resin polymerised at 190°C, previously degreased with phosphate-free nanotechnological treatment.
- C4H quality surface finish.

On request:

- ATEX and 2-speed motors.
- Made entirely of stainless steel.
- Made of hot dip galvanised steel.
- Marine motors for naval applications, certified for essential service in accordance with different classification entities (BV, DNV, LR).
- CE, NEMA, UL, CSA motors.
- C5M quality surface finish.

Order code

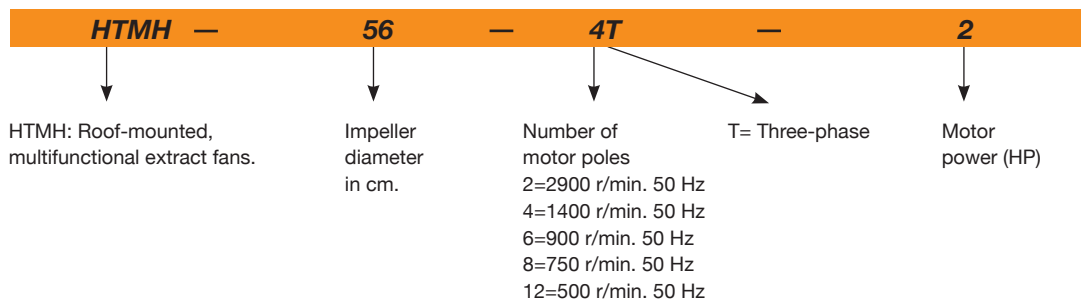

Technical characteristics

Model	Speed (r/min)	Maximum admissible current (A)			Installed power (kW)	Maximum flow rate (m ³ /h)	Sound pressure level ⁽¹⁾ dB(A)		Approx. weight (kg)	According to ErP
		230V	400V	690V			Inlet	Exhaust		
HTMH-56-4T-1 IE3	1420	2.82	1.62		0.75	10545	62	59	79	2015
HTMH-56-4T-1.5 IE3	1455	4.07	2.34		1.10	11400	63	60	79	2015
HTMH-56-6T-0.75	910	2.59	1.49		0.55	8170	51	49	80	2015
HTMH-63-4T-1.5 IE3	1455	4.07	2.34		1.10	13870	65	62	94	2015
HTMH-63-4/8T-1.5	1440 / 710		2.90 / 1.30		1.10 / 0.25	13870 / 6935	65 / 50	62 / 47	94	2015
HTMH-63-4T-2 IE3	1440	5.41	3.11		1.50	15485	66	63	96	2015
HTMH-63-4/8T-2	1420 / 700		3.50 / 1.50		1.50 / 0.37	15485 / 7742	66 / 51	63 / 48	106	2015
HTMH-63-4T-3 IE3	1435	7.93	4.56		2.20	17955	67	64	108	2015
HTMH-63-4/8T-3	1430 / 710		4.90 / 1.70		2.20 / 0.45	17955 / 8977	67 / 52	64 / 49	112	2015
HTMH-63-6T-0.75	910	2.59	1.49		0.55	10260	56	54	95	2015
HTMH-63-6T-1 IE3	940	3.36	1.93		0.75	11305	57	55	95	2015
HTMH-71-4T-2 IE3	1440	5.41	3.11		1.50	16150	69	66	109	2015

Technical characteristics

Model	Speed (r/min)	Maximum admissible current (A)			Installed power (kW)	Maximum flow rate (m ³ /h)	Sound pressure level ⁽¹⁾ dB(A)		Approx. weight (kg)	According to ErP
		230V	400V	690V			Inlet	Exhaust		
HTMH-71-4/8T-2	1420 / 700		3.50 / 1.50		1.50 / 0.37	16150 / 8075	69 / 54	66 / 51	119	2015
HTMH-71-4T-3 IE3	1435	7.93	4.56		2.20	18430	71	68	122	2015
HTMH-71-4/8T-3	1430 / 710		4.90 / 1.70		2.20 / 0.45	18430 / 9215	71 / 56	68 / 53	125	2015
HTMH-71-4T-4 IE3	1440	10.70	6.15		3.00	22610	72	69	133	2015
HTMH-71-4/8T-4	1430 / 710		6.50 / 2.30		3.00 / 0.60	22610 / 11305	72 / 57	69 / 54	135	2015
HTMH-71-6T-1 IE3	940	3.36	1.93		0.75	13205	58	56	109	2015
HTMH-71-6T-1.5 IE3	945	4.68	2.69		1.10	16245	59	57	116	2015
HTMH-80-4T-4 IE3	1440	10.70	6.15		3.00	27600	73	70	163	2015
HTMH-80-4/8T-4	1430 / 710		6.50 / 2.30		3.00 / 0.60	27600 / 13800	73 / 58	70 / 55	165	2015
HTMH-80-4T-5.5 IE3	1450	13.90	8.00		4.00	30176	74	71	163	2015
HTMH-80-4/8T-5.5	1430 / 710		8.20 / 2.90		4.00 / 0.80	30176 / 15088	74 / 59	71 / 56	195	2015
HTMH-80-6T-1.5 IE3	945	4.68	2.69		1.10	19412	62	60	145	2015
HTMH-80-6T-2 IE3	950	6.43	3.70		1.50	22172	63	61	148	2015
HTMH-80-6T-3 IE3	950	9.08	5.22		2.20	24932	64	62	160	2015
HTMH-90-4T-5.5 IE3	1450	13.90	8.00		4.00	35052	79	76	208	2015
HTMH-90-4/8T-5.5	1430 / 710		8.20 / 2.90		4.00 / 0.80	35052 / 17526	79 / 64	76 / 61	238	2015
HTMH-90-4T-7.5 IE3	1465		10.30	5.97	5.50	38456	81	78	240	2015
HTMH-90-4/8T-7.5	1450 / 720		11.80 / 3.80		5.50 / 1.10	38456 / 19228	81 / 66	78 / 63	243	2015
HTMH-90-4T-10 IE3	1465		13.90	8.06	7.50	41308	82	79	244	2015
HTMH-90-4/8T-9	1460 / 725		15.30 / 5.40		7.50 / 1.50	41308 / 20654	82 / 67	79 / 64	243	2015
HTMH-90-6T-3 IE3	950	9.08	5.22		2.20	29256	68	66	205	2015
HTMH-90-6/12T-3	940 / 470		5.60 / 2.20		2.20 / 0.37	29256 / 14628	68 / 53	66 / 51	245	2015
HTMH-90-6T-4 IE3	970	12.00	6.91		3.00	32016	69	67	235	2015
HTMH-90-6/12T-4	960 / 480		9.00 / 3.50		3.00 / 0.55	32016 / 16008	69 / 54	67 / 52	245	2015
HTMH-90-8T-1	705	4.68	2.70		0.75	17020	61	60	196	2015
HTMH-90-8T-2	705	7.10	4.10		1.50	19596	63	62	208	2015
HTMH-100-4T-7.5 IE3	1465		10.30	5.97	5.50	40756	84	81	265	2015
HTMH-100-4/8T-7.5	1450 / 720		11.80 / 3.80		5.50 / 1.10	40756 / 20378	84 / 69	81 / 66	269	2015
HTMH-100-4T-10 IE3	1465		13.90	8.06	7.50	47564	85	82	269	2015
HTMH-100-4/8T-9	1460 / 725		15.30 / 5.40		7.50 / 1.50	44528 / 22264	84 / 69	81 / 66	269	2015
HTMH-100-4T-15 IE3	1470		20.90	12.10	11.00	51336	86	83	332	2015
HTMH-100-6T-3 IE3	950	9.08	5.22		2.20	32476	74	72	231	2015
HTMH-100-6/12T-3	940 / 470		5.60 / 2.20		2.20 / 0.37	32476 / 16238	74 / 59	72 / 57	271	2015
HTMH-100-6T-4 IE3	970	12.00	6.91		3.00	35420	75	73	260	2015
HTMH-100-6T-5.5 IE3	960	15.60	8.99		4.00	40020	76	74	277	2015
HTMH-100-6/12T-5.5	970 / 480		11 / 4		4.00 / 0.65	40020 / 20010	76 / 61	74 / 59	289	2015
HTMH-125-4T/6-15 IE3	1470		21.40	12.40	11.00	66800	76	73	398	2015
HTMH-125-4T/6-20 IE3	1340		1.00		15.00	72900	76	73	393	2015
HTMH-125-4T/9-20 IE3	1340		1.00		15.00	76310	75	72	408	2015
HTMH-125-6T/6-5.5 IE3	960	15.60	8.99		4.00	47760	63	61	343	2015
HTMH-125-6T/6-7.5 IE3	970		11.20	6.49	5.50	55600	63	61	347	2015
HTMH-125-6T/6-10 IE3	970		14.80	8.58	7.50	66170	65	63	369	2015
HTMH-125-6T/6-15 IE3	970		22.00	12.80	11.00	76380	67	65	399	2015
HTMH-125-6T/9-7.5 IE3	970		11.20	6.49	5.50	50000	64	62	362	2015
HTMH-125-6T/9-10 IE3	970		14.80	8.58	7.50	59340	64	62	384	2015
HTMH-125-6T/9-15 IE3	970		22.00	12.80	11.00	71890	67	65	414	2015
HTMH-125-6T/9-20 IE3	975		28.00	16.20	15.00	83660	70	68	467	2015
HTMH-125-8T/6-4	705	12.82	7.40		3.00	47510	56	55	328	2015
HTMH-125-8T/6-5.5	710	16.11	9.30		4.00	52770	58	57	345	2015
HTMH-125-8T/6-7.5	710		12.00	7.20	5.50	60410	60	59	361	2015
HTMH-125-8T/6-10	725		16.00	9.50	7.50	66030	61	60	389	2015
HTMH-125-8T/9-5.5	710	16.11	9.30		4.00	51330	58	57	360	2015
HTMH-125-8T/9-7.5	710		12.00	7.20	5.50	54480	61	60	376	2015
HTMH-125-8T/9-10	725		16.00	9.50	7.50	65660	63	62	404	2015
HTMH-125-8T/9-15	720		24.00	13.80	11.00	73870	64	63	426	2015

(1) The noise level values are irradiated pressures in dB(A) measured at a distance of 14 m in a free field.

Acoustic characteristics

Noise power spectrum Lw(A) in dB(A) frequency band in [Hz]

Values measured at inlet with maximum flow rate

Model	63	125	250	500	1000	2000	4000	8000
56-4-1	46	67	74	79	82	78	71	60
56-4-1.5	47	68	75	80	83	79	72	61
56-6-0.75	35	56	63	68	71	67	60	49
63-4-1.5	49	70	77	82	85	81	74	63
63-4-2	50	71	78	83	86	82	75	64
63-4-3	51	72	79	84	87	83	76	65
63-6-0.75	40	61	68	73	76	72	65	54
63-6-1	41	62	69	74	77	73	66	55
63-8-1.5	34	55	62	67	70	66	59	48
63-8-2	35	56	63	68	71	67	60	49
63-8-3	36	57	64	69	72	68	61	50
71-4-2	53	74	81	86	89	85	78	67
71-4-3	55	76	83	88	91	87	80	69
71-4-4	56	77	84	89	92	88	81	70
71-6-1	42	63	70	75	78	74	67	56
71-6-1.5	43	64	71	76	79	75	68	57
71-8-2	38	59	66	71	74	70	63	52
71-8-3	40	61	68	73	76	72	65	54
71-8-4	41	62	69	74	77	73	66	55
80-4-4	57	78	85	90	93	89	82	71
80-4-5.5	58	79	86	91	94	90	83	72
80-6-1.5	46	67	74	79	82	78	71	60
80-6-2	47	68	75	80	83	79	72	61
80-6-3	48	69	76	81	84	80	73	62
80-8-4	42	63	70	75	78	74	67	56
80-8-5.5	43	64	71	76	79	75	68	57
90-4-5.5	63	84	91	96	99	95	88	77
90-4-7.5	65	86	93	98	101	97	90	79
90-4-9	66	87	94	99	102	98	91	80
90-4-10	66	87	94	99	102	98	91	80
90-6-3	52	73	80	85	88	84	77	66
90-6-4	53	74	81	86	89	85	78	67
90-8-1	45	66	73	78	81	77	70	59
90-8-2	47	68	75	80	83	79	72	61
90-8-5.5	48	69	76	81	84	80	73	62
90-8-7.5	50	71	78	83	86	82	75	64
90-8-9	51	72	79	84	87	83	76	65
90-12-3	37	58	65	70	73	69	62	51
90-12-4	38	59	66	71	74	70	63	52
100-4-7.5	68	89	96	101	104	100	93	82
100-4-9	68	89	96	101	104	100	93	82
100-4-10	69	90	97	102	105	101	94	83
100-4-15	70	91	98	103	106	102	95	84
100-6-3	58	79	86	91	94	90	83	72
100-6-4	59	80	87	92	95	91	84	73
100-6-5.5	60	81	88	93	96	92	85	74
100-8-7.5	53	74	81	86	89	85	78	67
100-8-9	53	74	81	86	89	85	78	67
100-12-3	43	64	71	76	79	75	68	57
100-12-5.5	45	66	73	78	81	77	70	59
125-4T/6-15	63	72	87	94	97	91	85	81
125-4T/6-20	63	72	87	94	97	91	85	81
125-4T/9-20	62	71	87	93	95	89	84	80
125-6T/6-5.5	56	66	78	81	83	79	68	64
125-6T/6-7.5	56	66	78	81	83	79	68	64
125-6T/6-10	58	68	80	83	85	81	70	66
125-6T/6-15	60	70	82	85	87	83	72	68
125-6T/9-7.5	54	65	79	83	83	81	70	66
125-6T/9-10	54	65	79	83	83	81	70	66
125-6T/9-15	57	68	82	86	86	84	73	69
125-6T/9-20	60	71	85	89	89	87	76	72
125-8T/6-4	50	59	70	75	75	69	58	54
125-8T/6-5.5	52	61	72	77	77	71	60	56
125-8T/6-7.5	54	63	74	79	79	73	62	58
125-8T/6-10	55	64	75	80	80	74	63	59
125-8T/9-5.5	49	61	70	76	78	72	61	57
125-8T/9-7.5	52	64	73	79	81	75	64	60
125-8T/9-10	54	66	75	81	83	77	66	62
125-8T/9-15	55	67	76	82	84	78	67	63

Values measured at exhaust with maximum flow rate

Model	63	125	250	500	1000	2000	4000	8000
56-4-1	43	64	71	76	79	75	68	57
56-4-1.5	44	65	72	77	80	76	69	58
56-6-0.75	33	54	61	66	69	65	58	47
63-4-1.5	46	67	74	79	82	78	71	60
63-4-2	47	68	75	80	83	79	72	61
63-4-3	48	69	76	81	84	80	73	62
63-6-0.75	38	59	66	71	74	70	63	52
63-6-1	39	60	67	72	75	71	64	53
63-8-1.5	31	52	59	64	67	63	56	45
63-8-2	32	53	60	65	68	64	57	46
63-8-3	33	54	61	66	69	65	58	47
71-4-2	50	71	78	83	86	82	75	64
71-4-3	52	73	80	85	88	84	77	66
71-4-4	53	74	81	86	89	85	78	67
71-6-1	40	61	68	73	76	72	65	54
71-6-1.5	41	62	69	74	77	73	66	55
71-8-2	35	56	63	68	71	67	60	49
71-8-3	37	58	65	70	73	69	62	51
71-8-4	38	59	66	71	74	70	63	52
80-4-4	54	75	82	87	90	86	79	68
80-4-5.5	55	76	83	88	91	87	80	69
80-6-1.5	44	65	72	77	80	76	69	58
80-6-2	45	66	73	78	81	77	70	59
80-6-3	46	67	74	79	82	78	71	60
80-8-4	39	60	67	72	75	71	64	53
80-8-5.5	40	61	68	73	76	72	65	54
90-4-5.5	60	81	88	93	96	92	85	74
90-4-7.5	62	83	90	95	98	94	87	76
90-4-9	63	84	91	96	99	95	88	77
90-4-10	63	84	91	96	99	95	88	77
90-6-3	50	71	78	83	86	82	75	64
90-6-4	51	72	79	84	87	83	76	65
90-8-1	44	65	72	77	80	76	69	58
90-8-2	46	67	74	79	82	78	71	60
90-8-5.5	45	66	73	78	81	77	70	59
90-8-7.5	47	68	75	80	83	79	72	61
90-8-9	48	69	76	81	84	80	73	62
90-12-3	35	56	63	68	71	67	60	49
90-12-4	36	57	64	69	72	68	61	50
100-4-7.5	65	86	93	98	101	97	90	79
100-4-9	65	86	93	98	101	97	90	79
100-4-10	66	87	94	99	102	98	91	80
100-4-15	67	88	95	100	103	99	92	81
100-6-3	56	77	84	89	92	88	81	70
100-6-4	57	78	85	90	93	89	82	71
100-6-5.5	58	79	86	91	94	90	83	72
100-8-7.5	50	71	78	83	86	82	75	64
100-8-9	50	71	78	83	86	82	75	64
100-12-3	41	62	69	74	77	73	66	55
100-12-5.5	43	64	71	76	79	75	68	57
125-4T/6-15	60	69	84	91	94	88	82	78
125-4T/6-20	60	69	84	91	94	88	82	78
125-4T/9-20	59	68	84	90	92	86	81	77
125-6T/6-5.5	54	64	76	79	81	77	66	62
125-6T/6-7.5	54	64	76	79	81	77	66	62
125-6T/6-10	56	66	78	81	83	79	68	64
125-6T/6-15	58	68	80	83	85	81	70	66
125-6T/9-7.5	52	63	77	81	81	79	68	64
125-6T/9-10	52	63	77	81	81	79	68	64
125-6T/9-15	55	66	80	84	84	82	71	67
125-6T/9-20	58	69	83	87	87	85	74	70
125-8T/6-4	49	58	69	74	74	68	57	53
125-8T/6-5.5	51	60	71	76	76	70	59	55
125-8T/6-7.5	53	62	73	78	78	72	61	57
125-8T/6-10	54	63	74	79	79	73	62	58
125-8T/9-5.5	48	60	69	75	77	71	60	56
125-8T/9-7.5	51	63	72	78	80	74	63	59
125-8T/9-10	53	65	74	80	82	76	65	61
125-8T/9-15	54	66	75	81	83	77	66	62



Erp. (Energy Related Products)

Information on Directive 2009/125/EC can be downloaded from the SODECA website or the QuickFan selector programme.

Dimensions mm

Model	A	B	C	D	F	G	H	I
HTMH-56	650	185	425	40	960	900	750	14
HTMH-63	680	215	425	40	1092	1000	850	14
HTMH-71	760	195	525	40	1120	1000	850	14
HTMH-80	790	215	525	50	1252	1150	1000	14
HTMH-90	910	232	638	40	1380	1150	1000	14
HTMH-100	1055	252	753	50	1527	1250	1100	14
HTMH-125	1170	312	808	50	1802	1425	1275	17

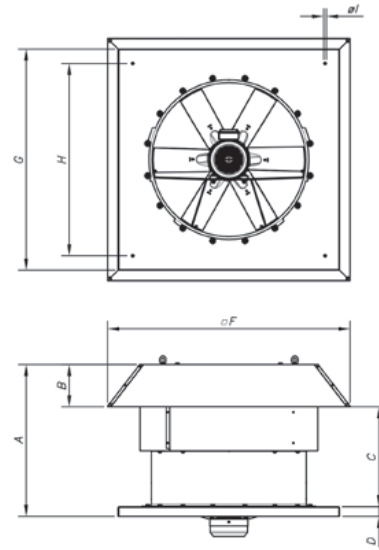

Characteristic curves

Q= Flow rate in m³/h, m³/s and cfm.

Pe= Static pressure in mmH₂O, Pa and inwg.

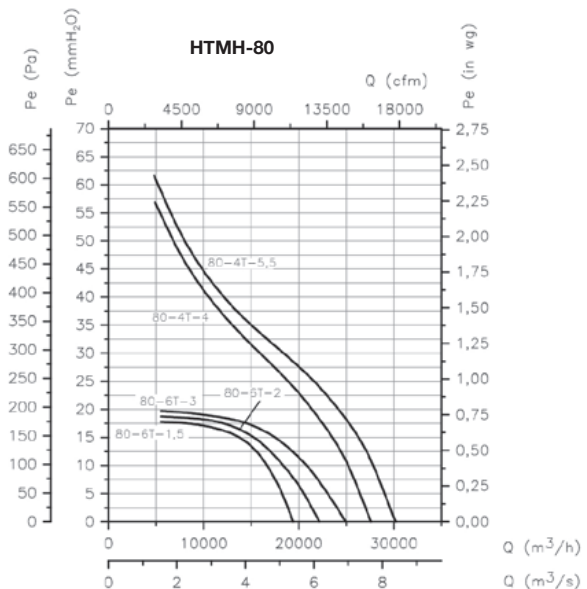
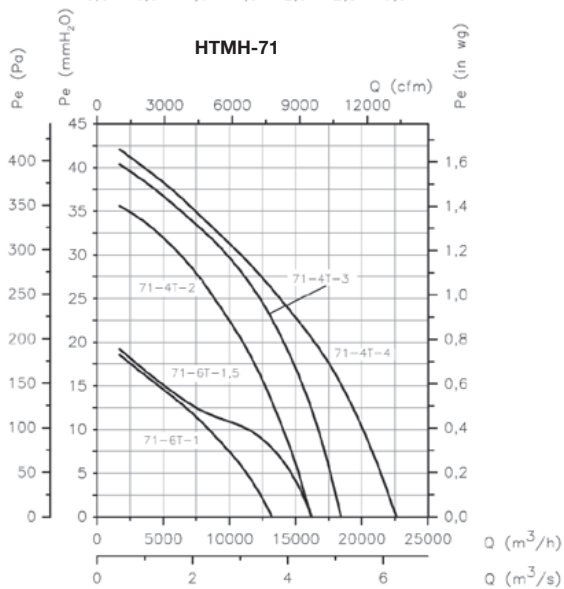
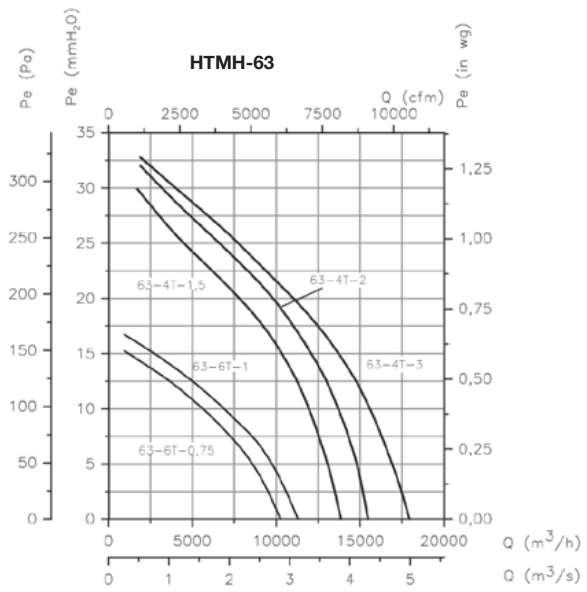
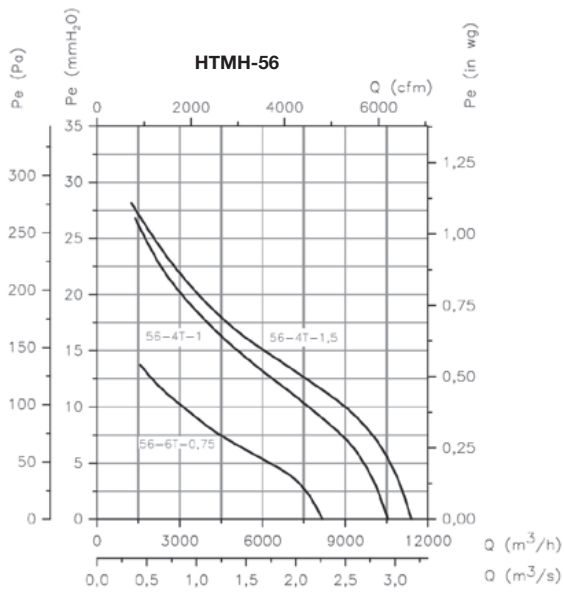

Characteristic curves

Q= Flow rate in m³/h, m³/s and cfm.

Pe= Static pressure in mmH₂O, Pa and inwg.

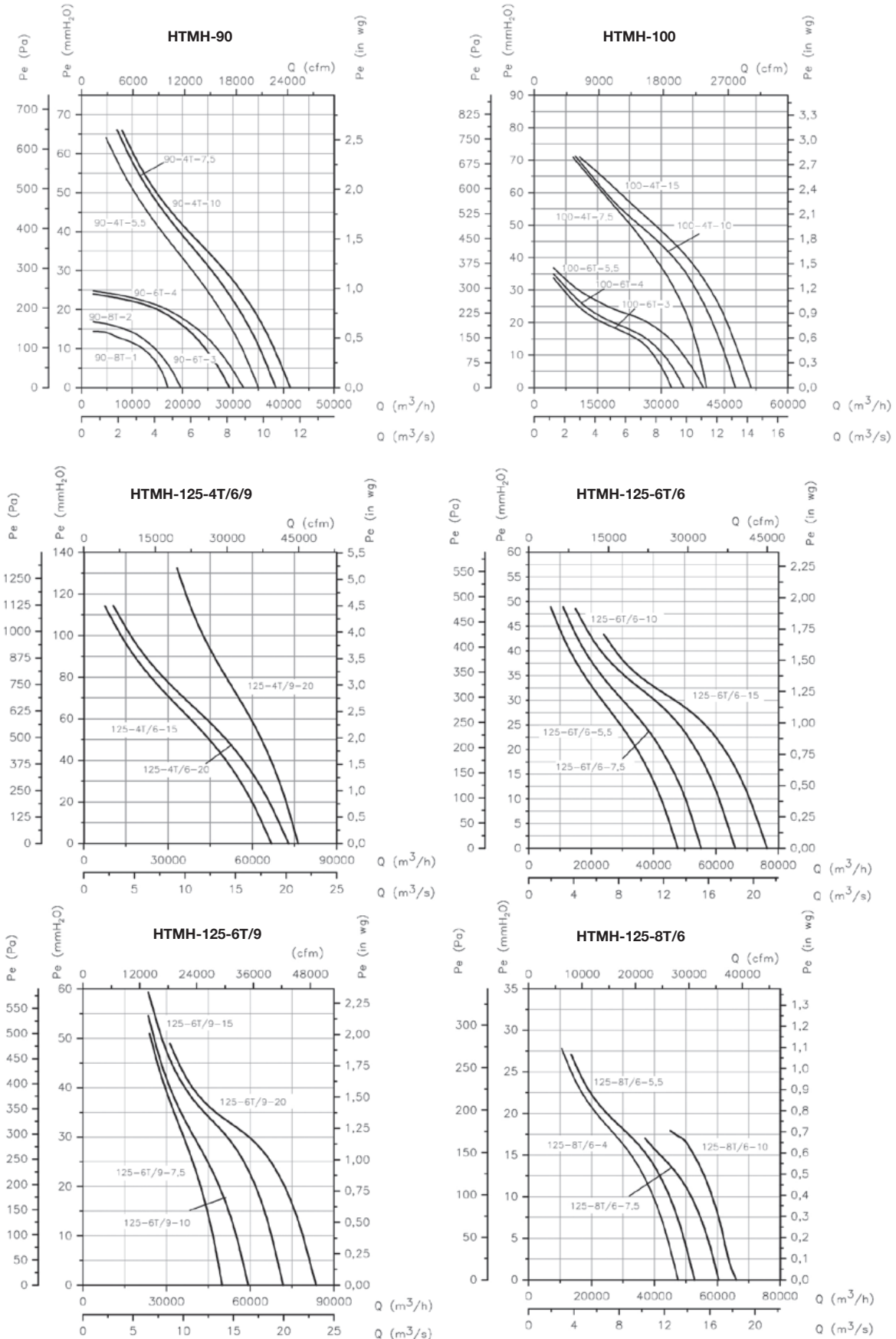

Characteristic curves

Q= Flow rate in m³/h, m³/s and cfm.

Pe= Static pressure in mmH₂O, Pa and inwg.

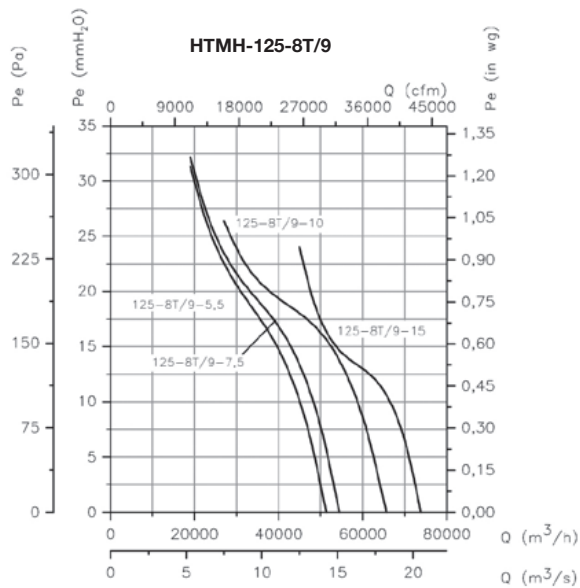

Sound pressure validation depending on distance

The noise level may vary depending on the roof or tile structure.

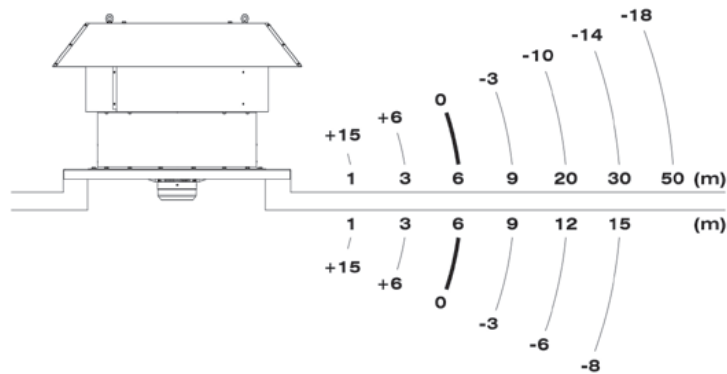

Accessories



HTMF



400°C/2h (F-400) and 300°C/2h (F-300) roof-mounted multifunctional extract fans

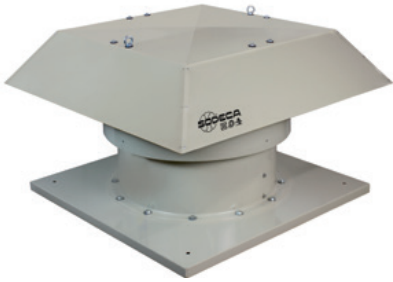

400°C/2h and 300°C/2h rated roof-mounted multifunctional extract fans for work in fire risk zones, designed for smoke extraction in industrial or similar buildings.

Fan:

- Painted, galvanised sheet steel support base.
- Cast aluminium orientable impellers.
- Anti-contact protective grille pursuant to standard UNE-EN ISO 12499.
- Painted, galvanised sheet steel rain cover, with natural air outlet. Approved in accordance with standard EN 12101-3, with certificates No. 0370-CPR 0544 (F-400) and 0370-CPR-3073 (F-300).

Motor:

- Class H motors, S1 continuous operation and S2 emergency use, with ball bearings, IP55 protection and with 1 or 2 speeds, depending on model.

- IE3 efficiency motors for powers equal to or higher than 0.75kW except single-phase, 2-speed and 8-pole.
- Three-phase 230/400V-50Hz (up to 3kW) and 400/690V-50Hz (powers higher than 3kW).
- Maximum temperature of air to be carried: S1 -20°C +40°C continuous service, also suitable for warm climates with temperatures up to 50°C. S2 operation, 300°C/2h, 400°C/2h.

Finish:

- Anti-corrosive finish of polyester resin polymerised at 190°C, previously degreased with phosphate-free nanotechnological treatment.

Order code

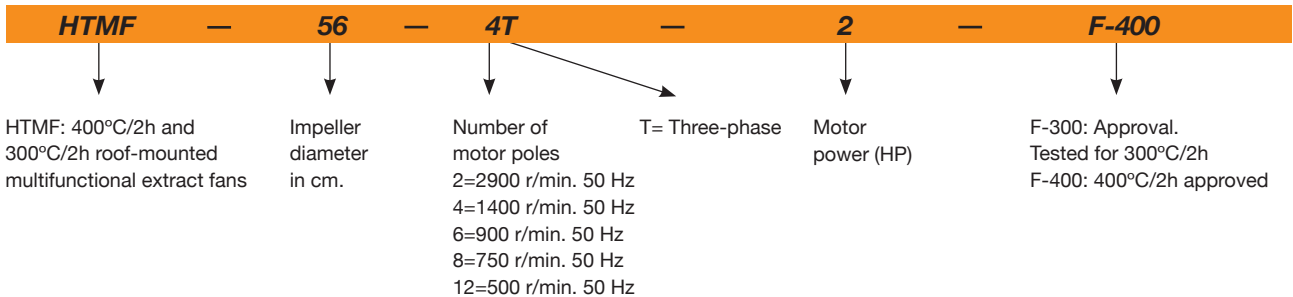

Technical characteristics

Model	Speed (r/min)	Maximum admissible current (A)			Installed power (kW)	Maximum flow rate (m³/h)	Sound pressure level ⁽¹⁾ dB(A)		Approx. weight (kg)	According to ErP
		230 V	400 V	690 V			Inlet	Exhaust		
HTMF-56-4T-1	1430	3.80	2.20		0.75	10545	62	59	79	2015
HTMF-56-4T-1.5	1420	4.70	2.70		1.10	11400	63	60	79	*
HTMF-56-4/8T-1.5	1440 / 710		2.90 / 1.40		1.10 / 0.25	11400 / 5700	63 / 48	60 / 45	79	*
HTMF-56-6T-0.75	930	3.30	1.90		0.55	8170	51	49	80	*
HTMF-63-4T-1.5	1420	4.70	2.70		1.10	13870	65	62	94	2015
HTMF-63-4/8T-1.5	1440 / 710		2.90 / 1.40		1.10 / 0.25	13870 / 6935	65 / 50	62 / 47	94	2015
HTMF-63-4T-2	1425	6.60	3.80		1.50	15485	66	63	96	2015
HTMF-63-4/8T-2	1415 / 715		3.60 / 1.50		1.50 / 0.30	15485 / 7742	66 / 51	63 / 48	106	2015
HTMF-63-4T-3	1435	9.20	5.30		2.20	17955	67	64	108	2015
HTMF-63-4/8T-3	1415 / 715		5.20 / 1.90		2.20 / 0.45	17955 / 8977	67 / 52	64 / 49	112	2015
HTMF-63-6T-0.75	930	3.30	1.90		0.55	10260	56	54	95	2015
HTMF-63-6T-1	940	4.40	2.60		0.75	11305	57	55	95	2015
HTMF-71-4T-2	1425	6.60	3.80		1.50	16150	69	66	109	2015
HTMF-71-4/8T-2	1415 / 715		3.60 / 1.50		1.50 / 0.30	16150 / 8075	69 / 54	66 / 51	119	2015
HTMF-71-4T-3	1435	9.20	5.30		2.20	18430	71	68	122	2015
HTMF-71-4/8T-3	1415 / 715		5.20 / 1.90		2.20 / 0.45	18430 / 9215	71 / 56	68 / 53	125	2015
HTMF-71-4T-4	1430	11.40	6.60		3.00	22610	72	69	133	2015

Technical characteristics

Model	Speed (r/min)	Maximum admissible current (A)			Installed power (kW)	Maximum flow rate (m ³ /h)	Sound pressure level ⁽¹⁾ dB(A)		Approx. weight (kg)	According to ErP
		230 V	400 V	690 V			Inlet	Exhaust		
HTMF-71-4/8T-4	1420 / 705		6.90 / 2.30		3.00 / 0.60	22610 / 11305	72 / 57	69 / 54	135	2015
HTMF-71-6T-1	940	4.40	2.60		0.75	13205	58	56	109	2015
HTMF-71-6T-1.5	945	6.40	3.70		1.10	16245	59	57	116	2015
HTMF-80-4T-4	1430	11.40	6.60		3.00	27600	73	70	163	2015
HTMF-80-4/8T-4	1420 / 705		6.90 / 2.30		3.00 / 0.60	27600 / 13800	73 / 58	70 / 55	165	2015
HTMF-80-4T-5.5	1440		8.40	4.85	4.00	30176	74	71	163	2015
HTMF-80-4/8T-5.5	1450 / 720		9.40 / 3.50		4.00 / 0.80	30176 / 15088	74 / 59	71 / 56	195	2015
HTMF-80-6T-1.5	945	6.40	3.70		1.10	19412	62	60	145	2015
HTMF-80-6T-2	945	7.40	4.30		1.50	22172	63	61	148	2015
HTMF-80-6T-3	950	10.30	5.90		2.20	24932	64	62	160	2015
HTMF-80-8T-1	710	4.80	2.80		0.75	16376	61	60	151	2015
HTMF-90-4T-5.5	1440		8.40	4.85	4.00	35052	79	76	208	2015
HTMF-90-4/8T-5.5	1450 / 720		9.40 / 3.50		4.00 / 0.80	35052 / 17526	79 / 64	76 / 61	238	2015
HTMF-90-4T-7.5	1430		11.50	6.64	5.50	38456	81	78	240	2015
HTMF-90-4/8T-7.5	1455 / 725		12.80 / 4.60		5.50 / 1.10	38456 / 19228	81 / 66	78 / 63	243	2015
HTMF-90-4T-10	1460		17.70	10.22	7.50	41308	82	79	244	2015
HTMF-90-4/8T-9	1455 / 725		15.50 / 5.50		6.70 / 1.50	41308 / 20654	82 / 67	79 / 64	243	2015
HTMF-90-6T-3	950	10.30	5.90		2.20	29256	68	66	205	2015
HTMF-90-6/12T-3	940 / 470		5.60 / 2.20		2.20 / 0.37	29256 / 14628	68 / 53	66 / 51	245	2015
HTMF-90-6T-4	945	15.00	8.70		3.00	32016	69	67	235	2015
HTMF-90-6/12T-4	970 / 475		8.90 / 3.50		3.00 / 0.55	32016 / 16008	69 / 54	67 / 52	245	2015
HTMF-90-8T-1	710	4.80	2.80		0.75	17020	61	60	196	2015
HTMF-90-8T-2	700	9.00	5.20		1.50	19596	63	62	208	2015
HTMF-100-4T-7.5	1430		11.50	6.64	5.50	40756	84	81	265	2015
HTMF-100-4/8T-7.5	1455 / 725		12.80 / 4.60		5.50 / 1.10	40756 / 20378	84 / 69	81 / 66	269	2015
HTMF-100-4T-10	1460		17.70	10.22	7.50	47564	85	82	269	2015
HTMF-100-4/8T-9	1455 / 725		15.50 / 5.50		6.70 / 1.50	44528 / 22264	84 / 69	81 / 66	269	2015
HTMF-100-4T-15	1455		23.00	13.28	11.00	51336	86	83	332	2015
HTMF-100-4/8T-14	1470 / 725		23.20 / 8.70		11.00 / 2.80	48300 / 24150	85 / 70	82 / 67	301	2015
HTMF-100-6T-3	950	10.30	5.90		2.20	32476	74	72	231	2015
HTMF-100-6/12T-3	940 / 470		5.60 / 2.20		2.20 / 0.37	32476 / 16238	74 / 59	72 / 57	271	2015
HTMF-100-6T-4	945	15.00	8.70		3.00	35420	75	73	260	2015
HTMF-100-6/12T-4	970 / 475		8.90 / 3.50		3.00 / 0.55	35420 / 17710	75 / 60	73 / 58	271	2015
HTMF-100-6T-5.5	970		11.00	6.35	4.00	40020	76	74	277	2015
HTMF-100-6/12T-5.5	970 / 480		11.30 / 4.20		4.00 / 0.65	40020 / 20010	76 / 61	74 / 59	289	2015
HTMF-100-8T-3	705	13.20	7.60		2.20	26404	69	68	260	2015
HTMF-100-8T-4	710	15.60	9.00		3.00	28704	70	69	270	2015
HTMF-THT-125-4T/6-15	1470		20.90	12.10	11.00	66800	76	73	388	2015
HTMF-THT-125-4T/6-20	1465		27.90	16.20	15.00	72900	76	73	410	2015
HTMF-THT-125-4T/9-20	1465		27.90	16.20	15.00	76310	75	72	425	2015
HTMF-THT-125-6T/6-5.5	970		11.00	6.35	4.00	47760	63	61	347	2015
HTMF-THT-125-6T/6-7.5	970		14.00	8.08	5.50	55600	63	61	384	2015
HTMF-THT-125-6T/6-10	975		14.80	8.58	7.50	66170	65	63	393	2015
HTMF-THT-125-6T/6-15	975		21.90	12.70	11.00	76380	67	65	415	2015
HTMF-THT-125-6T/9-7.5	970		14.00	8.08	5.50	50000	64	62	399	2015
HTMF-THT-125-6T/9-10	975		14.80	8.58	7.50	59340	64	62	408	2015
HTMF-THT-125-6T/9-15	975		21.90	12.70	11.00	71890	67	65	430	2015
HTMF-THT-125-6T/9-20	975		28.20	16.30	15.00	83660	70	68	475	2015
HTMF-THT-125-8T/6-4	710	15.60	9.00		3.00	47510	56	55	384	2015
HTMF-THT-125-8T/6-5.5	710		13.00	7.51	4.00	52770	58	57	404	2015
HTMF-THT-125-8T/6-7.5	710		15.10	8.72	5.50	60410	60	59	416	2015
HTMF-THT-125-8T/6-10	715		20.60	11.89	7.50	66030	61	60	424	2015
HTMF-THT-125-8T/9-5.5	710		13.00	7.51	4.00	51330	58	57	419	2015
HTMF-THT-125-8T/9-7.5	710		15.10	8.72	5.50	54480	61	60	431	2015
HTMF-THT-125-8T/9-10	715		20.60	11.89	7.50	65660	63	62	439	2015
HTMF-THT-125-8T/9-15	725		21.70	12.53	11.00	73870	64	63	472	2015

⁽¹⁾ The noise level values are pressures in dB(A) measured at a distance of 6 metres in a free field.
* Equipment not covered by Directive 2009/125/EC



Erp. (Energy Related Products)

Information on Directive 2009/125/EC can be downloaded from the SODECA website or the QuickFan selector programme.

Acoustic characteristics

Noise power spectrum Lw(A) in dB(A) frequency band in [Hz]

Values measured at inlet with maximum flow rate

Model	63	125	250	500	1000	2000	4000	8000
56-4-1	46	67	74	79	82	78	71	60
56-4-1.5	47	68	75	80	83	79	72	61
56-6-0.75	35	56	63	68	71	67	60	49
56-8-1.5	32	53	60	65	68	64	57	46
63-4-1.5	49	70	77	82	85	81	74	63
63-4-2	50	71	78	83	86	82	75	64
63-4-3	51	72	79	84	87	83	76	65
63-6-0.75	40	61	68	73	76	72	65	54
63-6-1	41	62	69	74	77	73	66	55
63-8-1.5	34	55	62	67	70	66	59	48
63-8-2	35	56	63	68	71	67	60	49
63-8-3	36	57	64	69	72	68	61	50
71-4-2	53	74	81	86	89	85	78	67
71-4-3	55	76	83	88	91	87	80	69
71-4-4	56	77	84	89	92	88	81	70
71-6-1	42	63	70	75	78	74	67	56
71-6-1.5	43	64	71	76	79	75	68	57
71-8-2	38	59	66	71	74	70	63	52
71-8-3	40	61	68	73	76	72	65	54
71-8-4	41	62	69	74	77	73	66	55
80-4-4	57	78	85	90	93	89	82	71
80-4-5.5	58	79	86	91	94	90	83	72
80-6-1.5	46	67	74	79	82	78	71	60
80-6-2	47	68	75	80	83	79	72	61
80-6-3	48	69	76	81	84	80	73	62
80-8-1	45	66	73	78	81	77	70	59
80-8-4	42	63	70	75	78	74	67	56
80-8-5.5	43	64	71	76	79	75	68	57
90-4-5.5	63	84	91	96	99	95	88	77
90-4-7.5	65	86	93	98	101	97	90	79
90-4-9	66	87	94	99	102	98	91	80
90-4-10	66	87	94	99	102	98	91	80
90-6-3	52	73	80	85	88	84	77	66
90-6-4	53	74	81	86	89	85	78	67
90-8-1	45	66	73	78	81	77	70	59
90-8-2	47	68	75	80	83	79	72	61
90-8-5.5	48	69	76	81	84	80	73	62
90-8-7.5	50	71	78	83	86	82	75	64
90-8-9	51	72	79	84	87	83	76	65
90-12-3	37	58	65	70	73	69	62	51
90-12-4	38	59	66	71	74	70	63	52
100-4-7.5	68	89	96	101	104	100	93	82
100-4-9	68	89	96	101	104	100	93	82
100-4-10	69	90	97	102	105	101	94	83
100-4-14	69	90	97	102	105	101	94	83
100-4-15	70	91	98	103	106	102	95	84
100-6-3	58	79	86	91	94	90	83	72
100-6-4	59	80	87	92	95	91	84	73
100-6-5.5	60	81	88	93	96	92	85	74
100-8-3	53	74	81	86	89	85	78	67
100-8-4	54	75	82	87	90	86	79	68
100-8-7.5	53	74	81	86	89	85	78	67
100-8-9	53	74	81	86	89	85	78	67
100-8-14	54	75	82	87	90	86	79	68
100-12-3	43	64	71	76	79	75	68	57
100-12-4	44	65	72	77	80	76	69	58
100-12-5.5	45	66	73	78	81	77	70	59
125-4T/6-15	63	72	87	94	97	91	85	81
125-4T/6-20	63	72	87	94	97	91	85	81
125-4T/9-20	62	71	87	93	95	89	84	80
125-6T/6-5.5	56	66	78	81	83	79	68	64
125-6T/6-7.5	56	66	78	81	83	79	68	64
125-6T/6-10	58	68	80	83	85	81	70	66
125-6T/6-15	60	70	82	85	87	83	72	68
125-6T/9-7.5	54	65	79	83	83	81	70	66
125-6T/9-10	54	65	79	83	83	81	70	66
125-6T/9-15	57	68	82	86	86	84	73	69
125-6T/9-20	60	71	85	89	89	87	76	72
125-8T/6-4	50	59	70	75	75	69	58	54
125-8T/6-5.5	52	61	72	77	77	71	60	56
125-8T/6-7.5	54	63	74	79	79	73	62	58
125-8T/6-10	55	64	75	80	80	74	63	59
125-8T/9-5.5	49	61	70	76	78	72	61	57
125-8T/9-7.5	52	64	73	79	81	75	64	60
125-8T/9-10	54	66	75	81	83	77	66	62
125-8T/9-15	55	67	76	82	84	78	67	63

Values measured at exhaust with maximum flow rate

Model	63	125	250	500	1000	2000	4000	8000
56-4-1	43	64	71	76	79	75	68	57
56-4-1.5	44	65	72	77	80	76	69	58
56-6-0.75	33	54	61	66	69	65	58	47
56-8-1.5	29	50	57	62	65	61	54	43
63-4-1.5	46	67	74	79	82	78	71	60
63-4-2	47	68	75	80	83	79	72	61
63-4-3	48	69	76	81	84	80	73	62
63-6-0.75	38	59	66	71	74	70	63	52
63-6-1	39	60	67	72	75	71	64	53
63-8-1.5	31	52	59	64	67	63	56	45
63-8-2	32	53	60	65	68	64	57	46
63-8-3	33	54	61	66	69	65	58	47
71-4-2	50	71	78	83	86	82	75	64
71-4-3	52	73	80	85	88	84	77	66
71-4-4	53	74	81	86	89	85	78	67
71-6-1	40	61	68	73	76	72	65	54
71-6-1.5	41	62	69	74	77	73	66	55
71-8-2	35	56	63	68	71	67	60	49
71-8-3	37	58	65	70	73	69	62	51
71-8-4	38	59	66	71	74	70	63	52
80-4-4	54	75	82	87	90	86	79	68
80-4-5.5	55	76	83	88	91	87	80	69
80-6-1.5	44	65	72	77	80	76	69	58
80-6-2	45	66	73	78	81	77	70	59
80-6-3	46	67	74	79	82	78	71	60
80-8-1	44	65	72	77	80	76	69	58
80-8-4	39	60	67	72	75	71	64	53
80-8-5.5	40	61	68	73	76	72	65	54
90-4-5.5	60	81	88	93	96	92	85	74
90-4-7.5	62	83	90	95	98	94	87	76
90-4-9	63	84	91	96	99	95	88	77
90-4-10	63	84	91	96	99	95	88	77
90-6-3	50	71	78	83	86	82	75	64
90-6-4	51	72	79	84	87	83	76	65
90-8-1	44	65	72	77	80	76	69	58
90-8-2	46	67	74	79	82	78	71	60
90-8-5.5	45	66	73	78	81	77	70	59
90-8-7.5	47	68	75	80	83	79	72	61
90-8-9	48	69	76	81	84	80	73	62
90-12-3	35	56	63	68	71	67	60	49
90-12-4	36	57	64	69	72	68	61	50
100-4-7.5	65	86	93	98	101	97	90	79
100-4-9	65	86	93	98	101	97	90	79
100-4-10	66	87	94	99	102	98	91	80
100-4-14	66	87	94	99	102	98	91	80
100-4-15	67	88	95	100	103	99	92	81
100-6-3	56	77	84	89	92	88	81	70
100-6-4	57	78	85	90	93	89	82	71
100-6-5.5	58	79	86	91	94	90	83	72
100-8-3	52	73	80	85	88	84	77	66
100-8-4	53	74	81	86	89	85	78	67
100-8-7.5	50	71	78	83	86	82	75	64
100-8-9	50	71	78	83	86	82	75	64
100-8-14	51	72	79	84	87	83	76	65
100-12-3	41	62	69	74	77	73	66	55
100-12-4	42	63	70	75	78	74	67	56
100-12-5.5	43	64	71	76	79	75	68	57
125-4T/6-15	60	69	84	91	94	88	82	78
125-4T/6-20	60	69	84	91	94	88	82	78
125-4T/9-20	59	68	84	90	92	86	81	77
125-6T/6-5.5	54	64	76	79	81	77	66	62
125-6T/6-7.5	54	64	76	79	81	77	66	62
125-6T/6-10	56	66	78	81	83	79	68	64
125-6T/6-15	58	68	80	83	85	81	70	66
125-6T/9-7.5	52	63	77	81	81	79	68	64
125-6T/9-10	52	63	77	81	81	79	68	64
125-6T/9-15	55	66	80	84	84	82	71	67
125-6T/9-20	58	69	83	87	87	85	74	70
125-8T/6-4	49	58	69	74	74	68	57	53
125-8T/6-5.5	51	60	71	76	76	70	59	55
125-8T/6-7.5	53	62	73	78	78	72	61	57
125-8T/6-10	54	63	74	79	79	73	62	58
125-8T/9-5.5	48	60	69	75	77	71	60	56
125-8T/9-7.5	51	63	72	78	80	74	63	59
125-8T/9-10	53	65	74	80	82	76	65	61
125-8T/9-15	54	66	75	81	83	77	66	62

Dimensions mm

Model	A	B	C	D	F	G	H	I
HTMF-56	650	185	425	40	960	900	750	14
HTMF-63	680	215	425	40	1092	1000	850	14
HTMF-71	760	195	525	40	1120	1000	850	14
HTMF-80	790	215	525	50	1252	1150	1000	14
HTMF-90	910	232	638	40	1380	1150	1000	14
HTMF-100	1055	252	753	50	1527	1250	1100	14
HTMF-125	1170	312	808	50	1802	1425	1275	17

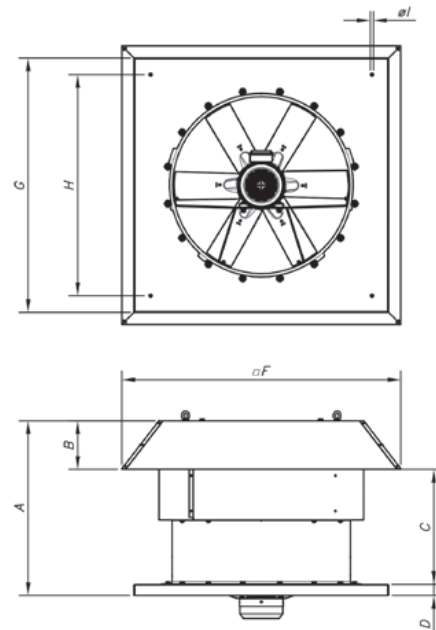

Characteristic curves

Q= Flow rate in m³/h, m³/s and cfm.

Pe= Static pressure in mmH₂O, Pa and inwg.

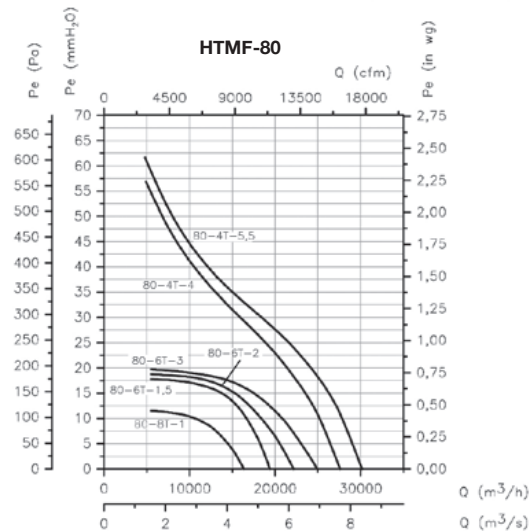
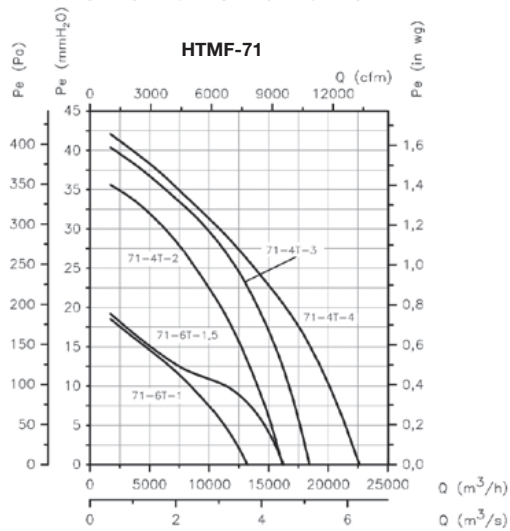
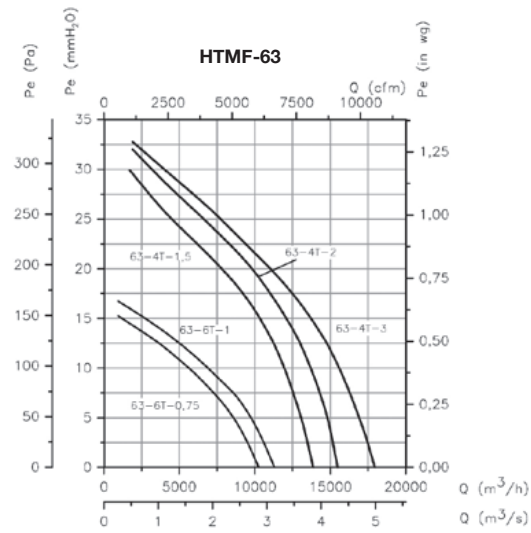
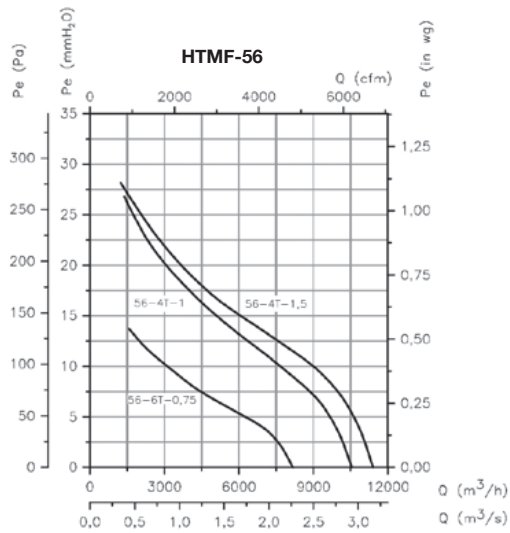

Characteristic curves

Q= Flow rate in m³/h, m³/s and cfm.

Pe= Static pressure in mmH₂O, Pa and inwg.

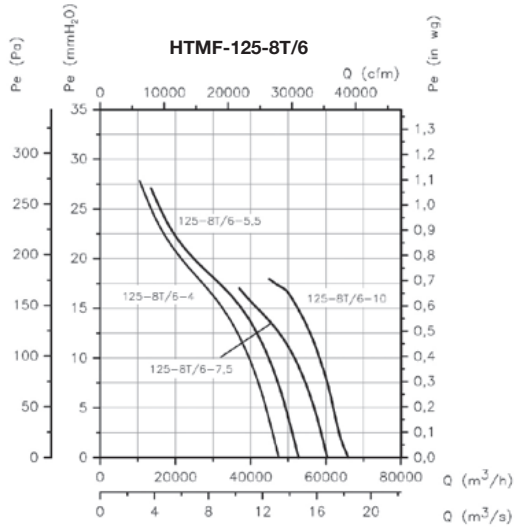
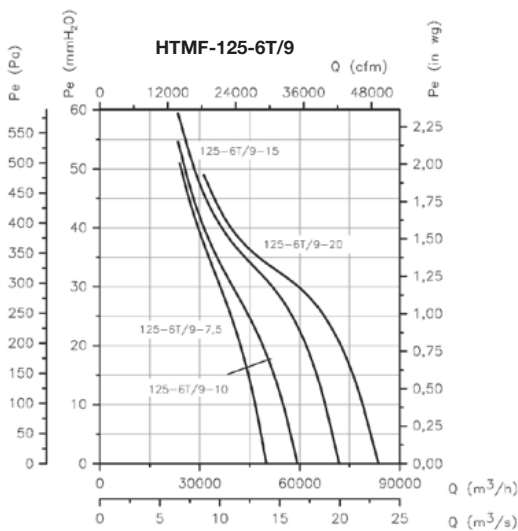
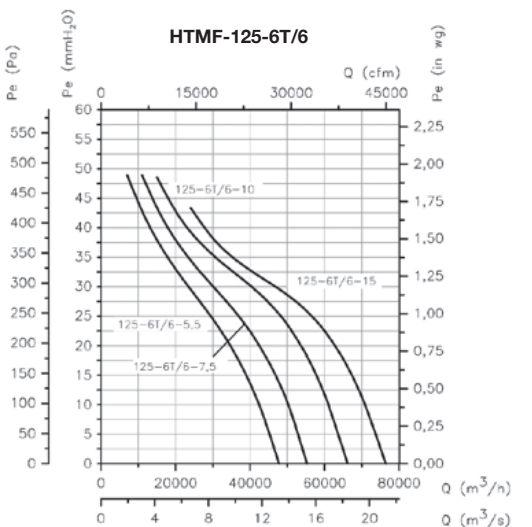
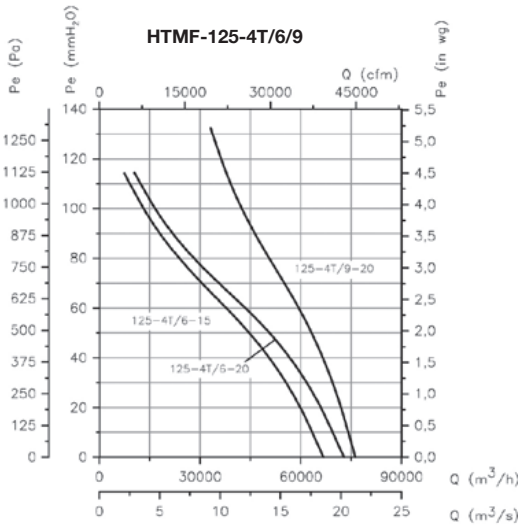
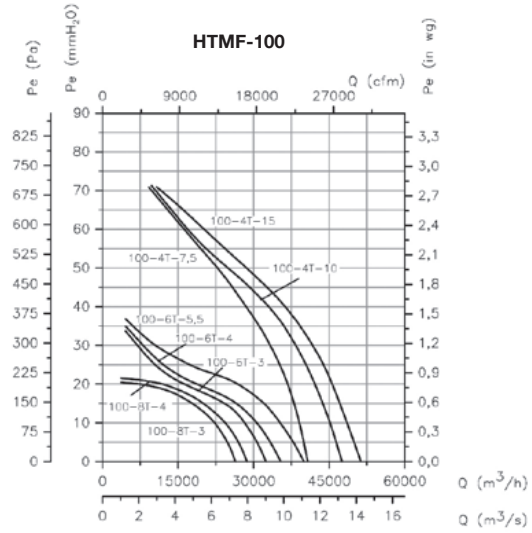
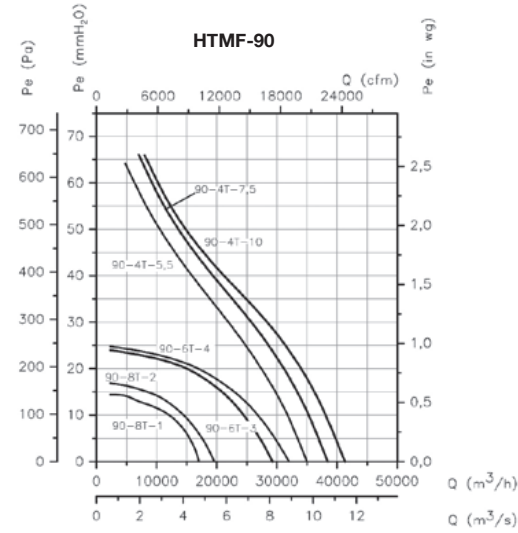

Characteristic curves

Q= Flow rate in m³/h, m³/s and cfm.

Pe= Static pressure in mmH₂O, Pa and inwg.

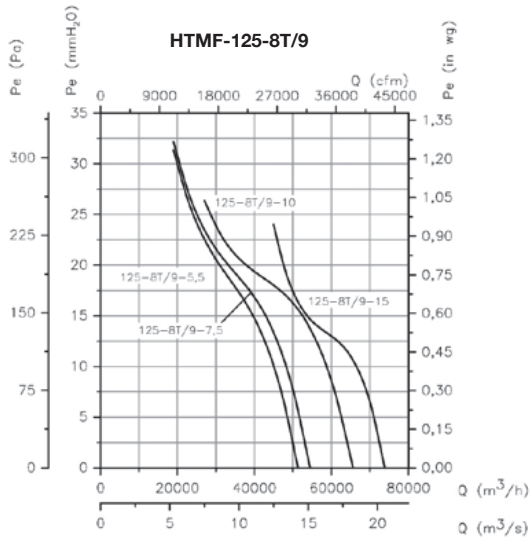

Sound pressure validation depending on distance

The noise level may vary depending on the roof or tile structure.

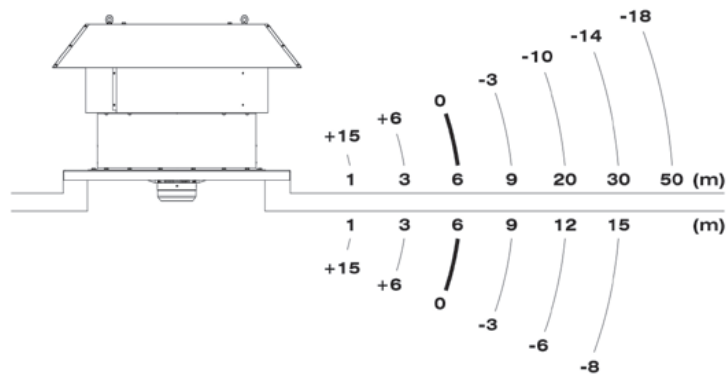

Accessories

See accessories section.



HTMV



Roof-mounted axial extract fans with vertical air outlets



Roof-mounted axial extract fans with vertical air outlet, designed for extracting large air volumes in industrial or similar premises.

Fan:

- Galvanised sheet steel support base with anti-corrosive treatment.
- Cast aluminium orientable impellers.
- Anti-contact protective grille pursuant to standard UNE-EN ISO 12499.
- Anti-return hatch in aluminium sheet metal to prevent the entry of water when the fan is not operating.
- Airflow direction from motor to impeller.

Motor:

- Class F motors with ball bearings and IP55 protection.
- IE3 efficiency motors for powers equal to or greater than 0.75 kW except single-phase, 2-speed and 8-pole.

- Three-phase 230/400 V-50 Hz (up to 4 kW) and 400/690 V-50 Hz (powers higher than 4 kW).
- Maximum temperature of air to be carried: -20°C+ 40°C.

Finish:

- Anti-corrosive finish of polyester resin polymerised at 190°C, previously degreased with phosphate-free nanotechnological treatment.

On request:

- Extract fans with 2-speed motors
- 2 and 8-pole fans depending on diameter.
- Special windings for different voltages and frequencies.
- Made entirely of stainless steel.
- Made of hot dip galvanised steel.

Order code

From sizes 56 to 100

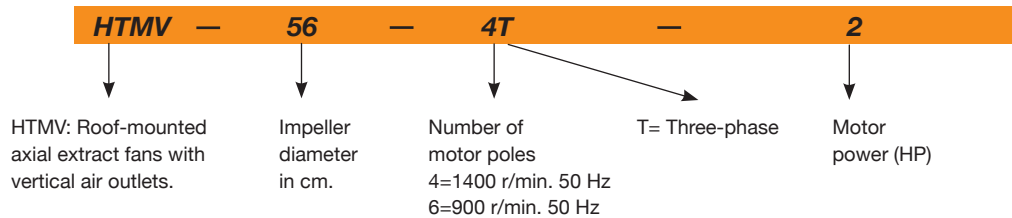

Size 125

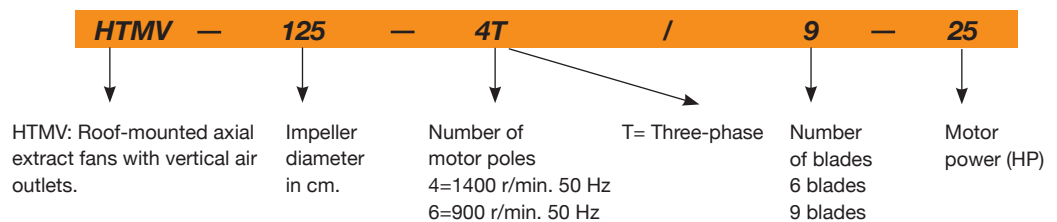

Technical characteristics

Model	Speed (r/min)	Maximum admissible current (A)			Installed power (kW)	Maximum flow rate (m³/h)	Sound pressure level ⁽¹⁾ dB(A)		Approx. weight (kg)	According to ErP
		230V	400V	690V			Inlet	Exhaust		
HTMV-56-4T-1 IE3	1420	2.82	1.62		0.75	11250	63	58	61	2015
HTMV-56-4T-1.5 IE3	1455	4.07	2.34		1.10	13600	64	59	60	2015
HTMV-56-4T-2 IE3	1440	5.41	3.11		1.50	15050	65	60	71	2015
HTMV-56-6T-0.75	900	2.99	1.73		0.55	10150	52	48	60	2015
HTMV-63-4T-1.5 IE3	1455	4.07	2.34		1.10	17800	63	59	69	2015
HTMV-63-4T-2 IE3	1440	5.41	3.11		1.50	19300	63	59	81	2015
HTMV-63-4T-3 IE3	1435	7.93	4.56		2.20	22150	65	61	83	2015
HTMV-63-4T-4 IE3	1440	10.7	6.15		3.00	24250	66	62	93	2015
HTMV-63-6T-0.75	900	2.99	1.73		0.55	13600	55	51	70	2015
HTMV-63-6T-1 IE3	940	3.36	1.93		0.75	15900	57	53	72	2015
HTMV-71-4T-2 IE3	1440	5.41	3.11		1.50	20900	68	64	88	2015
HTMV-71-4T-3 IE3	1435	7.93	4.56		2.20	25100	67	63	90	2015

Technical characteristics

Model	Speed (r/min)	Maximum admissible current (A)			Installed power (kW)	Maximum flow rate (m³/h)	Sound pressure level ⁽¹⁾ dB(A)		Approx. weight (kg)	According to ErP
		230V	400V	690V			Inlet	Exhaust		
HTMV-71-4T-4 IE3	1440	10.7	6.15		3.00	27500	68	64	100	2015
HTMV-71-6T-0.75	900	2.99	1.73		0.55	16100	56	53	77	2015
HTMV-71-6T-1 IE3	940	3.36	1.93		0.75	17300	57	53	79	2015
HTMV-71-6T-1.5 IE3	945	4.68	2.69		1.10	19950	58	54	90	2015
HTMV-80-4T-4 IE3	1440	10.7	6.15		3.00	30250	71	67	122	2015
HTMV-80-4T-5.5 IE3	1450	13.9	8		4.00	32750	71	67	125	2015
HTMV-80-6T-1.5 IE3	945	4.68	2.69		1.10	21450	61	57	112	2015
HTMV-80-6T-2 IE3	950	6.43	3.7		1.50	25950	62	58	120	2015
HTMV-80-6T-3 IE3	950	9.08	5.22		2.20	29950	63	59	122	2015
HTMV-90-4T-5.5 IE3	1450	13.9	8		4.00	38900	75	71	138	2015
HTMV-90-4T-7.5 IE3	1465		10.3	5.97	5.50	46150	74	70	185	2015
HTMV-90-4T-10 IE3	1465		13.9	8.06	7.50	50150	73	69	141	2015
HTMV-90-6T-2 IE3	950	6.43	3.7		1.50	28800	64	60	133	2015
HTMV-90-6T-3 IE3	950	9.08	5.22		2.20	34000	65	60	136	2015
HTMV-90-6T-4 IE3	970	12	6.91		3.00	38900	66	62	172	2015
HTMV-100-4T-7.5 IE3	1465		10.3	5.97	5.50	46850	79	75	196	2015
HTMV-100-4T-10 IE3	1465		13.9	8.06	7.50	57400	77	73	152	2015
HTMV-100-4T-15 IE3	1470		21.4	12.4	11.00	66300	76	72	231	2015
HTMV-100-4T-20 IE3	1465		28.7	16.6	15.00	76150	78	74	222	2015
HTMV-100-6T-3 IE3	950	9.08	5.22		2.20	37600	67	64	148	2015
HTMV-100-6T-4 IE3	970	12	6.91		3.00	41150	67	62	184	2015
HTMV-100-6T-5.5 IE3	960	15.6	8.99		4.00	47800	68	64	177	2015
HTMV-125-4T/6-25 IE3	1470		33.6	19.5	18.50	92550	80	75	437	2015
HTMV-125-4T/6-30 IE3	1475		40.6	23.5	22.00	98850	80	75	452	2015
HTMV-125-4T/6-40 IE3	1480		55.9	32.4	30.00	117450	82	77	497	2015
HTMV-125-4T/6-50 IE3	1480		69.2	40.1	37.00	131050	83	78	537	2015
HTMV-125-4T/9-25 IE3	1470		33.6	19.5	18.50	79650	78	73	446	2015
HTMV-125-4T/9-30 IE3	1475		40.6	23.5	22.00	88300	79	74	461	2015
HTMV-125-4T/9-40 IE3	1480		55.9	32.4	30.00	104050	81	76	506	2015
HTMV-125-4T/9-50 IE3	1480		69.2	40.1	37.00	118400	83	78	546	2015
HTMV-125-6T/6-5.5 IE3	960	15.6	8.99		4.00	51500	66	62	282	2015
HTMV-125-6T/6-7.5 IE3	970		11.2	6.49	5.50	60650	66	62	260	2015
HTMV-125-6T/6-10 IE3	970		14.8	8.58	7.50	72650	68	64	279	2015
HTMV-125-6T/6-15 IE3	970		22	12.8	11.00	85850	70	66	332	2015
HTMV-125-6T/6-20 IE3	975		28	16.2	15.00	92850	71	67	438	2015
HTMV-125-6T/9-10 IE3	970		14.8	8.58	7.50	63500	68	64	288	2015
HTMV-125-6T/9-15 IE3	970		22	12.8	11.00	77550	71	67	341	2015
HTMV-125-6T/9-20 IE3	975		28	16.2	15.00	92950	74	70	447	2015

(1) The noise level values are pressures in dB(A) measured at a distance of 6 metres in a free field.



Erp. (Energy Related Products)

Information on Directive 2009/125/EC can be downloaded from the SODECA website or the QuickFan selector programme.

Acoustic characteristics

The indicated values are determined by measuring the pressure and sound power levels in dB(A) obtained in a free field at a distance of 6 m.

Noise power spectrum Lw(A) in dB(A) frequency band in [Hz]

Values measured at inlet with maximum flow rate									Values measured at exhaust with maximum flow rate								
Model	63	125	250	500	1000	2000	4000	8000	Model	63	125	250	500	1000	2000	4000	8000
56-4-1	48	68	76	81	83	80	73	62	56-4-1	43	63	71	76	78	75	68	57
56-4-1.5	49	69	77	82	84	81	74	63	56-4-1.5	44	64	72	77	79	76	69	58
56-4-2	50	70	78	83	85	82	75	64	56-4-2	45	65	73	78	80	77	70	59
56-6-0.75	37	57	65	70	72	69	62	51	56-6-0.75	33	53	61	66	68	65	58	47
63-4-1.5	48	68	76	81	83	80	73	65	63-4-1.5	44	64	72	77	79	76	69	60
63-4-2	52	68	76	81	83	80	73	66	63-4-2	47	64	72	77	79	76	69	61
63-4-3	53	70	78	83	85	82	77	67	63-4-3	48	66	74	79	81	78	73	62
63-4-4	54	71	79	84	86	83	78	68	63-4-4	49	67	75	80	82	79	74	63
63-6-0.75	42	60	68	73	75	72	65	56	63-6-0.75	38	56	64	69	71	68	61	52
63-6-1	43	62	70	75	77	74	67	57	63-6-1	39	58	66	71	73	70	63	53
71-4-2	53	73	81	86	88	85	78	70	71-4-2	49	69	77	82	84	81	74	65
71-4-3	58	72	80	85	87	84	77	71	71-4-3	53	68	76	81	83	80	73	67
71-4-4	59	73	81	86	88	85	78	72	71-4-4	54	69	77	82	84	81	74	68
71-6-0.75	44	63	72	74	76	73	66	55	71-6-0.75	40	60	68	71	73	70	63	52
71-6-1	45	65	73	75	77	74	67	56	71-6-1	41	61	69	71	73	70	63	52
71-6-1.5	46	66	71	76	78	75	68	57	71-6-1.5	42	62	67	72	74	71	64	53
80-4-4	56	76	84	89	91	88	81	74	80-4-4	52	72	80	85	87	84	77	69

Acoustic characteristics

The indicated values are determined by measuring the pressure and sound power levels in dB(A) obtained in a free field at a distance of 6 m.

Noise power spectrum Lw(A) in dB(A) frequency band in [Hz]

Values measured at inlet with maximum flow rate

Model	63	125	250	500	1000	2000	4000	8000
80-4-5.5	56	76	84	89	91	88	81	74
80-6-1.5	49	66	74	79	81	78	71	60
80-6-2	50	67	75	80	82	79	72	61
80-6-3	51	68	76	81	83	80	73	62
90-4-5.5	60	81	88	93	96	92	85	74
90-4-7.5	59	80	87	92	95	91	84	73
90-4-10	58	79	86	91	94	90	83	72
90-6-2	49	70	77	82	85	81	74	63
90-6-3	56	70	77	82	85	81	74	63
90-6-4	57	72	79	84	87	83	76	65
100-4-7.5	64	84	92	97	99	96	89	78
100-4-10	62	82	90	95	97	94	87	76
100-4-15	61	81	89	94	96	93	86	75
100-4-20	63	83	91	96	98	95	88	77
100-6-3	61	72	80	85	87	84	77	66
100-6-4	64	72	80	85	87	84	77	66
100-6-5.5	64	73	81	86	88	85	78	67
125-4/6-25	68	76	92	99	101	96	90	86
125-4/6-30	68	76	92	99	101	96	90	86
125-4/6-40	70	78	94	101	103	98	92	88
125-4/6-50	71	79	95	102	104	99	93	89
125-4/9-25	66	74	91	97	98	93	88	84
125-4/9-30	67	75	92	98	99	94	89	85
125-4/9-40	69	77	94	100	101	96	91	87
125-4/9-50	71	79	96	102	103	98	93	89
125-6/6-5.5	60	69	82	85	86	83	72	68
125-6/6-7.5	60	69	82	85	86	83	72	68
125-6/6-10	62	71	84	87	88	85	74	70
125-6/6-15	64	73	86	89	90	87	76	72
125-6/6-20	65	74	87	90	91	88	77	73
125-6/9-10	58	68	83	87	86	85	74	70
125-6/9-15	61	71	86	90	89	88	77	73
125-6/9-20	64	74	89	93	92	91	80	76

Values measured at exhaust with maximum flow rate

Model	63	125	250	500	1000	2000	4000	8000
80-4-5.5	52	72	80	85	87	84	77	70
80-6-1.5	45	62	70	75	77	74	67	56
80-6-2	46	63	71	76	78	75	68	57
80-6-3	47	64	72	77	79	76	69	58
90-4-5.5	56	77	84	89	92	88	81	70
90-4-7.5	55	76	83	88	91	87	80	69
90-4-10	54	75	82	87	90	86	79	68
90-6-2	45	66	73	78	81	77	70	59
90-6-3	52	66	73	78	81	77	70	59
90-6-4	53	68	75	80	83	79	72	61
100-4-7.5	60	80	88	93	95	92	85	74
100-4-10	58	78	86	91	93	90	83	72
100-4-15	57	77	85	90	92	89	82	71
100-4-20	59	79	87	92	94	91	84	73
100-6-3	58	69	77	82	84	81	74	63
100-6-4	59	67	75	80	82	79	72	61
100-6-5.5	60	69	77	82	84	81	74	63
125-4/6-25	63	71	87	94	96	91	85	81
125-4/6-30	63	71	87	94	96	91	85	81
125-4/6-40	65	73	89	96	98	93	87	83
125-4/6-50	66	74	90	97	99	94	88	84
125-4/9-25	61	69	86	92	93	88	83	79
125-4/9-30	62	70	87	93	94	89	84	80
125-4/9-40	64	72	89	95	96	91	86	82
125-4/9-50	66	74	91	97	98	93	88	84
125-6/6-5.5	56	65	78	81	82	79	68	64
125-6/6-7.5	56	65	78	81	82	79	68	64
125-6/6-10	58	67	80	83	84	81	70	66
125-6/6-15	60	69	82	85	86	83	72	68
125-6/6-20	61	70	83	86	87	84	73	69
125-6/9-10	54	64	79	83	82	81	70	66
125-6/9-15	57	67	82	86	85	84	73	69
125-6/9-20	60	70	85	89	88	87	76	72

Dimensions mm

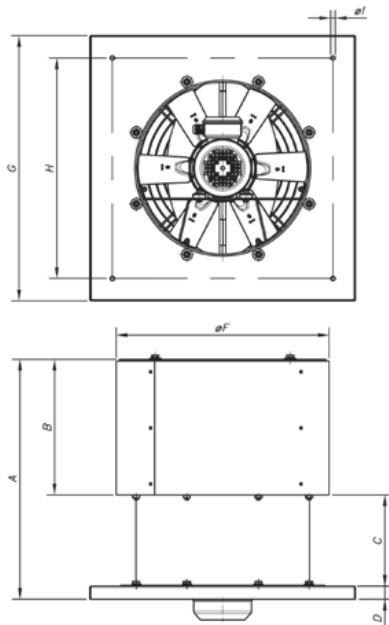

Model	A	B	C	D	ØF	G	H	ØI
HTMV-40	628	349	244	35	519	630	530	12
HTMV-45	642	363	244	35	569	710	590	12
HTMV-50	679	400	244	35	626	900	750	12
HTMV-56	710	426	244	40	686	900	750	14
HTMV-63	747	463	244	40	753	1000	850	14
HTMV-71	830	498	292	40	833	1000	850	14
HTMV-80	887	545	292	50	923	1150	1000	14
HTMV-90	989	601	338	50	1031	1150	1000	14
HTMV-100	1136	648	438	50	1128	1250	1100	14
HTMV-125	1313	775	488	50	1376	1425	1275	17

Characteristic curves

See THT/ROOF series

Accessories

See accessories section.



THT/ROOF

400°C/2h and 300°C/2h roof-mounted axial extract fans with vertical air outlets



Roof-mounted axial extract fans with vertical air outlets, for immersed operation in fire risk zones, designed for smoke extraction in industrial or similar buildings.

Fan:

- Galvanised sheet steel support base with anti-corrosive treatment.
- Cast aluminium orientable impellers.
- Anti-contact protective grille pursuant to standard UNE-EN ISO 12499.
- Anti-return hatch in aluminium sheet metal to prevent the entry of water when the fan is not operating.
- Approved in accordance with standard EN 12101-3. With 0370-CPR-3080 (F400) and 0370-CPR-3056 (F300) certifications.
- Airflow direction from motor to impeller.

Motor:

- IE3 efficiency motors for powers equal to or higher than 0.75kW except single-phase, 2-speed and 8-pole.

- Class H motors for S1 continuous operation and S2 emergency use. With ball bearings and class IP55 protection.
- Three-phase 230/400 V-50 Hz (up to 3 kW) and 400/690 V-50 Hz (powers higher than 3 kW).
- Maximum temperature of air to be carried: S1 -20°C +40°C continuous service, also suitable for warm climates with temperatures up to 50°C. S2 operation, 300°C/2h, 400°C/2h.

Finish:

- Anti-corrosive finish of polyester resin polymerised at 190°C, previously degreased with phosphate-free nanotechnological treatment.

On request:

- Extract fans with 2-speed motors
- 2 and 8-pole fans depending on diameter.

Order code

From size 40 to size 100

THT/ROOF	—	56	—	4T	—	2	—	F400
↓		↓		↓		↓		↓
THT/ROOF: 400°C/2h and 300°C/2h roof-mounted axial extract fans with vertical air outlets		Impeller diameter in cm		Number of motor poles T: Three-phase		Motor power (HP)		F-300: Approval. Tested for 300°C/2h. F-400: 400°C/2h approved

Size 120

THT/ROOF	—	125	—	4T/9	—	24	—	F400	
↓		↓		↓		↓		↓	
THT/ROOF: 400°C/2h and 300°C/2h roof-mounted axial extract fans with vertical air outlets		Impeller diameter in cm		Number of motor poles T: Three-phase		Number of blades 6 blades 9 blades		Motor power (HP)	F-300: Approval. Tested for 300°C/2h. F-400: 400°C/2h approved

Technical characteristics

Model	Speed (r/min)	Maximum admissible current (A)			Installed power (kW)	Blade inclination angle (°)	Maximum flow rate (m³/h)	Sound pressure level ⁽¹⁾ dB(A)		Approx. weight (kg)	According to ErP
		230V	400V	690V				Inlet	Exhaust		
THT/ROOF-40-4T-0.75	1420	2.90	1.70		0.55	32	4800	51	46	39	*
THT/ROOF-40-6T-0.75	930	3.30	1.90		0.55	32	3150	40	36	44	2015
THT/ROOF-45-4T-0.75	1420	2.90	1.70		0.55	36	7450	55	50	42	*
THT/ROOF-45-6T-0.75	930	3.30	1.90		0.55	30	4450	42	38	47	*
THT/ROOF-50-4T-1	1430	3.80	2.20		0.75	28	9750	59	54	51	*
THT/ROOF-50-6T-0.75	930	3.30	1.90		0.55	32	7000	47	43	54	*
THT/ROOF-56-4T-1	1430	3.80	2.20		0.75	22	11250	63	58	58	2015
THT/ROOF-56-4T-1.5	1420	4.70	2.70		1.10	30	13600	64	59	58	*

AXIAL FANS AND ROOF-MOUNTED EXTRACT FANS

Technical characteristics

Model	Speed (r/min)	Maximum admissible current (A)			Installed power (kW)	Blade inclination angle (°)	Maximum flow rate (m³/h)	Sound pressure level ⁽¹⁾ dB(A)		Approx. weight (kg)	According to ErP
		230V	400V	690V				Inlet	Exhaust		
THT/ROOF-56-4T-2	1425	6.60	3.80		1.50	36	15050	65	60	61	*
THT/ROOF-56-6T-0.75	930	3.30	1.90		0.55	38	10150	52	48	57	*
THT/ROOF-63-4T-1.5	1420	4.70	2.70		1.10	20	17800	63	59	67	2015
THT/ROOF-63-4T-2	1425	6.60	3.80		1.50	24	19300	63	59	71	2015
THT/ROOF-63-4T-3	1435	9.20	5.30		2.20	32	22150	65	61	76	2015
THT/ROOF-63-4T-4	1430	11.40	6.60		3.00	38	24250	66	62	85	2015
THT/ROOF-63-6T-0.75	930	3.30	1.90		0.55	28	13600	55	51	67	2015
THT/ROOF-63-6T-1	940	4.40	2.60		0.75	38	15900	57	53	70	2015
THT/ROOF-71-4T-2	1425	6.60	3.80		1.50	14	20900	68	64	78	2015
THT/ROOF-71-4T-3	1435	9.20	5.30		2.20	22	25100	67	63	83	2015
THT/ROOF-71-4T-4	1430	11.40	6.60		3.00	28	27500	68	64	92	2015
THT/ROOF-71-6T-0.75	930	3.30	1.90		0.55	20	16100	56	53	74	2015
THT/ROOF-71-6T-1	940	4.40	2.60		0.75	26	17300	57	53	77	2015
THT/ROOF-71-6T-1.5	945	6.40	3.70		1.10	34	19950	58	54	83	2015
THT/ROOF-80-4T-4	1430	11.40	6.60		3.00	16	30250	71	67	114	2015
THT/ROOF-80-4T-5.5	1440		8.40	4.85	4.00	18	32750	71	67	121	2015
THT/ROOF-80-6T-1.5	945	6.40	3.70		1.10	18	21450	61	57	105	2015
THT/ROOF-80-6T-2	945	7.40	4.30		1.50	26	25950	62	58	114	2015
THT/ROOF-80-6T-3	950	10.30	5.90		2.20	32	29950	63	59	120	2015
THT/ROOF-90-4T-5.5	1440		8.40	4.85	4.00	12	38900	75	71	134	2015
THT/ROOF-90-4T-7.5	1430		11.50	6.64	5.50	18	46150	74	70	161	2015
THT/ROOF-90-4T-10	1460		17.70	10.22	7.50	22	50150	73	69	172	2015
THT/ROOF-90-6T-2	945	7.40	4.30		1.50	16	28800	64	60	127	2015
THT/ROOF-90-6T-3	950	10.30	5.90		2.20	24	34000	65	60	134	2015
THT/ROOF-90-6T-4	945	15.00	8.70		3.00	30	38900	66	62	159	2015
THT/ROOF-100-4T-7.5	1430		11.50	6.64	5.50	10	46850	79	75	172	2015
THT/ROOF-100-4T-10	1460		17.70	10.22	7.50	16	57400	77	73	183	2015
THT/ROOF-100-4T-15	1455		23.00	13.28	11.00	22	66300	76	72	236	2015
THT/ROOF-100-4T-20	1460		29.00	16.74	15.00	28	76150	78	74	251	2015
THT/ROOF-100-6T-3	950	10.30	5.90		2.20	16	37600	67	64	146	2015
THT/ROOF-100-6T-4	945	15.00	8.70		3.00	20	41150	67	62	171	2015
THT/ROOF-100-6T-5.5	970		11.00	6.35	4.00	26	47800	68	64	183	2015
THT/ROOF-125-4T/6-25	1465		37.00	21.36	18.50	14	92550	80	75	413	2015
THT/ROOF-125-4T/6-30	1470		42.00	24.25	22.00	16	98850	80	75	427	2015
THT/ROOF-125-4T/6-40	1475		58.00	33.49	30.00	22	117450	82	77	507	2015
THT/ROOF-125-4T/6-50	1480		73.00	42.15	37.00	26	131050	83	78	543	2015
THT/ROOF-125-4T/9-25	1465		37.00	21.36	18.50	10	79650	78	73	422	2015
THT/ROOF-125-4T/9-30	1470		42.00	24.25	22.00	12	88300	79	74	436	2015
THT/ROOF-125-4T/9-40	1475		58.00	33.49	30.00	16	104050	81	76	516	2015
THT/ROOF-125-4T/9-50	1480		73.00	42.15	37.00	20	118400	83	78	552	2015
THT/ROOF-125-6T/6-5.5	970		11.00	6.35	4.00	10	51500	66	62	288	2015
THT/ROOF-125-6T/6-7.5	970		14.00	8.08	5.50	14	60650	66	62	295	2015
THT/ROOF-125-6T/6-10	960		18.60	10.74	7.50	20	72650	68	64	325	2015
THT/ROOF-125-6T/6-15	955		26.00	15.01	11.00	26	85850	70	66	355	2015
THT/ROOF-125-6T/6-20	950		35.50	20.50	15.00	30	92850	71	67	413	2015
THT/ROOF-125-6T/9-10	960		18.60	10.74	7.50	14	63500	68	64	334	2015
THT/ROOF-125-6T/9-15	955		26.00	15.01	11.00	20	77550	71	67	364	2015
THT/ROOF-125-6T/9-20	950		35.50	20.50	15.00	26	92950	74	70	422	2015

(1) The noise level values are pressures in dB(A) measured at a distance of 6 metres in a free field.
* Equipment not covered by Directive 2009/125/EC

Accessories

See accessories section.



Acoustic characteristics

Sound power spectrum Lw(A) in dB(A) per Hz frequency band.

Values measured at inlet with maximum flow rate.

Model	63	125	250	500	1000	2000	4000	8000
40-4-0.75	36	57	64	69	72	68	61	50
40-6-0.75	25	46	53	58	61	57	50	39
45-4-0.75	40	61	68	73	76	72	65	54
45-6-0.75	27	48	55	60	63	59	52	41
50-4-1	44	64	72	77	79	76	69	58
50-6-0.75	32	52	60	65	67	64	57	46
56-4-1	48	68	76	81	83	80	73	62
56-4-1.5	49	69	77	82	84	81	74	63
56-4-2	50	70	78	83	85	82	75	64
56-6-0.75	37	57	65	70	72	69	62	51
63-4-1.5	48	68	76	81	83	80	73	65
63-4-2	52	68	76	81	83	80	73	66
63-4-3	53	70	78	83	85	82	77	67
63-4-4	54	71	79	84	86	83	78	68
63-6-0.75	42	60	68	73	75	72	65	56
63-6-1	43	62	70	75	77	74	67	57
71-4-2	53	73	81	86	88	85	78	70
71-4-3	58	72	80	85	87	84	77	71
71-4-4	59	73	81	86	88	85	78	72
71-6-0.75	44	63	72	74	76	73	66	55
71-6-1	45	65	73	75	77	74	67	56
71-6-1.5	46	66	71	76	78	75	68	57
80-4-4	56	76	84	89	91	88	81	74
80-4-5.5	56	76	84	89	91	88	81	74
80-6-1.5	49	66	74	79	81	78	71	60
80-6-2	50	67	75	80	82	79	72	61
80-6-3	51	68	76	81	83	80	73	62
90-4-5.5	60	81	88	93	96	92	85	74
90-4-7.5	59	80	87	92	95	91	84	73
90-4-10	58	79	86	91	94	90	83	72
90-6-2	49	70	77	82	85	81	74	63
90-6-3	56	70	77	82	85	81	74	63
90-6-4	57	72	79	84	87	83	76	65
100-4-7.5	64	84	92	97	99	96	89	78
100-4-10	62	82	90	95	97	94	87	76
100-4-15	61	81	89	94	96	93	86	75
100-4-20	63	83	91	96	98	95	88	77
100-6-3	61	72	80	85	87	84	77	66
100-6-4	64	72	80	85	87	84	77	66
100-6-5.5	64	73	81	86	88	85	78	67
125-4/6-25	68	76	92	99	101	96	90	86
125-4/6-30	68	76	92	99	101	96	90	86
125-4/6-40	70	78	94	101	103	98	92	88
125-4/6-50	71	79	95	102	104	99	93	89
125-4/9-25	66	74	91	97	98	93	88	84
125-4/9-30	67	75	92	98	99	94	89	85
125-4/9-40	69	77	94	100	101	96	91	87
125-4/9-50	71	79	96	102	103	98	93	89
125-6/6-5.5	60	69	82	85	86	83	72	68
125-6/6-7.5	60	69	82	85	86	83	72	68
125-6/6-10	62	71	84	87	88	85	74	70
125-6/6-15	64	73	86	89	90	87	76	72
125-6/6-20	65	74	87	90	91	88	77	73
125-6/9-10	58	68	83	87	86	85	74	70
125-6/9-15	61	71	86	90	89	88	77	73
125-6/9-20	64	74	89	93	92	91	80	76

Values measured at exhaust with maximum flow rate.

Model	63	125	250	500	1000	2000	4000	8000
40-4-0.75	31	52	59	64	67	63	56	45
40-6-0.75	21	42	49	54	57	53	46	35
45-4-0.75	35	56	63	68	71	67	60	49
45-6-0.75	23	44	51	56	59	55	48	37
50-4-1	39	59	67	72	74	71	64	53
50-6-0.75	28	48	56	61	63	60	53	42
56-4-1	43	63	71	76	78	75	68	57
56-4-1.5	44	64	72	77	79	76	69	58
56-4-2	45	65	73	78	80	77	70	59
56-6-0.75	33	53	61	66	68	65	58	47
63-4-1.5	44	64	72	77	79	76	69	60
63-4-2	47	64	72	77	79	76	69	61
63-4-3	48	66	74	79	81	78	73	62
63-4-4	49	67	75	80	82	79	74	63
63-6-0.75	38	56	64	69	71	68	61	52
63-6-1	39	58	66	71	73	70	63	53
71-4-2	49	69	77	82	84	81	74	65
71-4-3	53	68	76	81	83	80	73	67
71-4-4	54	69	77	82	84	81	74	68
71-6-0.75	40	60	68	71	73	70	63	52
71-6-1	41	61	69	71	73	70	63	52
71-6-1.5	42	62	67	72	74	71	64	53
80-4-4	52	72	80	85	87	84	77	69
80-4-5.5	52	72	80	85	87	84	77	70
80-6-1.5	45	62	70	75	77	74	67	56
80-6-2	46	63	71	76	78	75	68	57
80-6-3	47	64	72	77	79	76	69	58
90-4-5.5	56	77	84	89	92	88	81	70
90-4-7.5	55	76	83	88	91	87	80	69
90-4-10	54	75	82	87	90	86	79	68
90-6-2	45	66	73	78	81	77	70	59
90-6-3	52	66	73	78	81	77	70	59
90-6-4	53	68	75	80	83	79	72	61
100-4-7.5	60	80	88	93	95	92	85	74
100-4-10	58	78	86	91	93	90	83	72
100-4-15	57	77	85	90	92	89	82	71
100-4-20	59	79	87	92	94	91	84	73
100-6-3	58	69	77	82	84	81	74	63
100-6-4	59	67	75	80	82	79	72	61
100-6-5.5	60	69	77	82	84	81	74	63
125-4/6-25	63	71	87	94	96	91	85	81
125-4/6-30	63	71	87	94	96	91	85	81
125-4/6-40	65	73	89	96	98	93	87	83
125-4/6-50	66	74	90	97	99	94	88	84
125-4/9-25	61	69	86	92	93	88	83	79
125-4/9-30	62	70	87	93	94	89	84	80
125-4/9-40	64	72	89	95	96	91	86	82
125-4/9-50	66	74	91	97	98	93	88	84
125-6/6-5.5	56	65	78	81	82	79	68	64
125-6/6-7.5	56	65	78	81	82	79	68	64
125-6/6-10	58	67	80	83	84	81	70	66
125-6/6-15	60	69	82	85	86	83	72	68
125-6/6-20	61	70	83	86	87	84	73	69
125-6/9-10	54	64	79	83	82	81	70	66
125-6/9-15	57	67	82	86	85	84	73	69
125-6/9-20	60	70	85	89	88	87	76	72

Dimensions mm

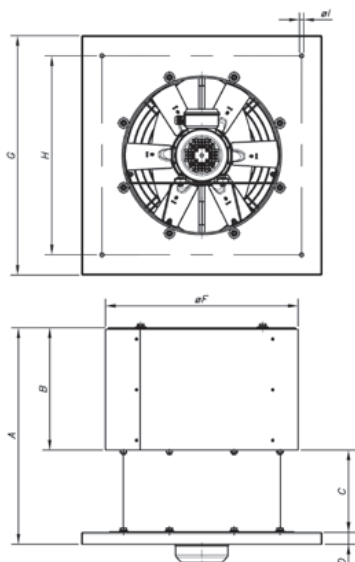

Model	A	B	C	D	ØF	G	H	ØI
THT/ROOF-40	628	349	244	35	519	630	530	12
THT/ROOF-45	642	363	244	35	569	710	590	12
THT/ROOF-50	679	400	244	35	626	900	750	12
THT/ROOF-56	710	426	244	40	686	900	750	14
THT/ROOF-63	747	463	244	40	753	1000	850	14
THT/ROOF-71	830	498	292	40	833	1000	850	14
THT/ROOF-80	887	545	292	50	923	1150	1000	14
THT/ROOF-90	989	601	338	50	1031	1150	1000	14
THT/ROOF-100	1136	648	438	50	1128	1250	1100	14
THT/ROOF-125	1313	775	488	50	1376	1425	1275	17

Characteristic curves

Q= Flow rate in m³/h, m³/s and cfm.

Pe= Static pressure in mm H₂O, Pa and inwg.

40-4T

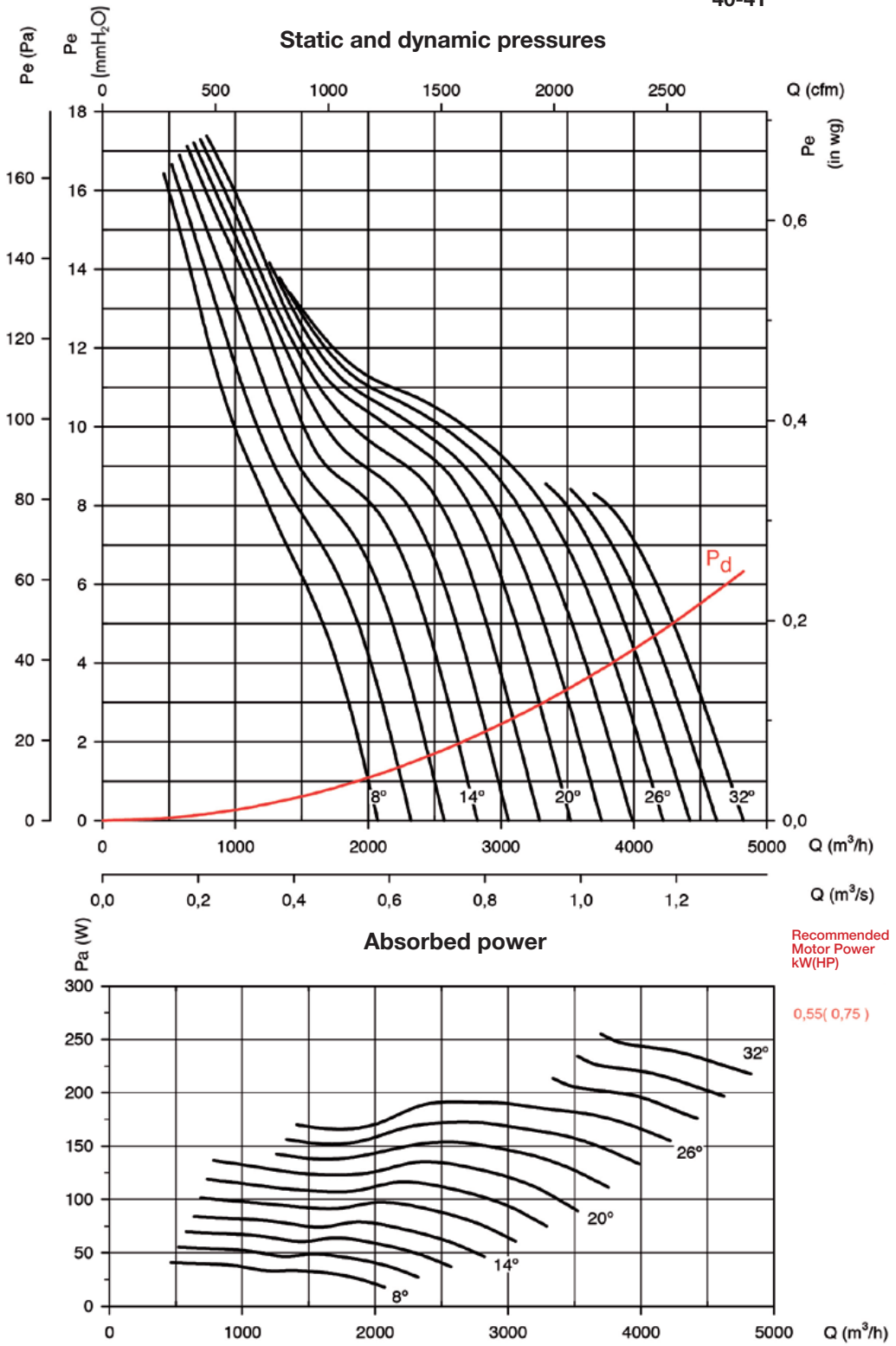

Characteristic curves

Q= Flow rate in m³/h, m³/s and cfm.

Pe= Static pressure in mm H₂O, Pa and inwg.

40-6T

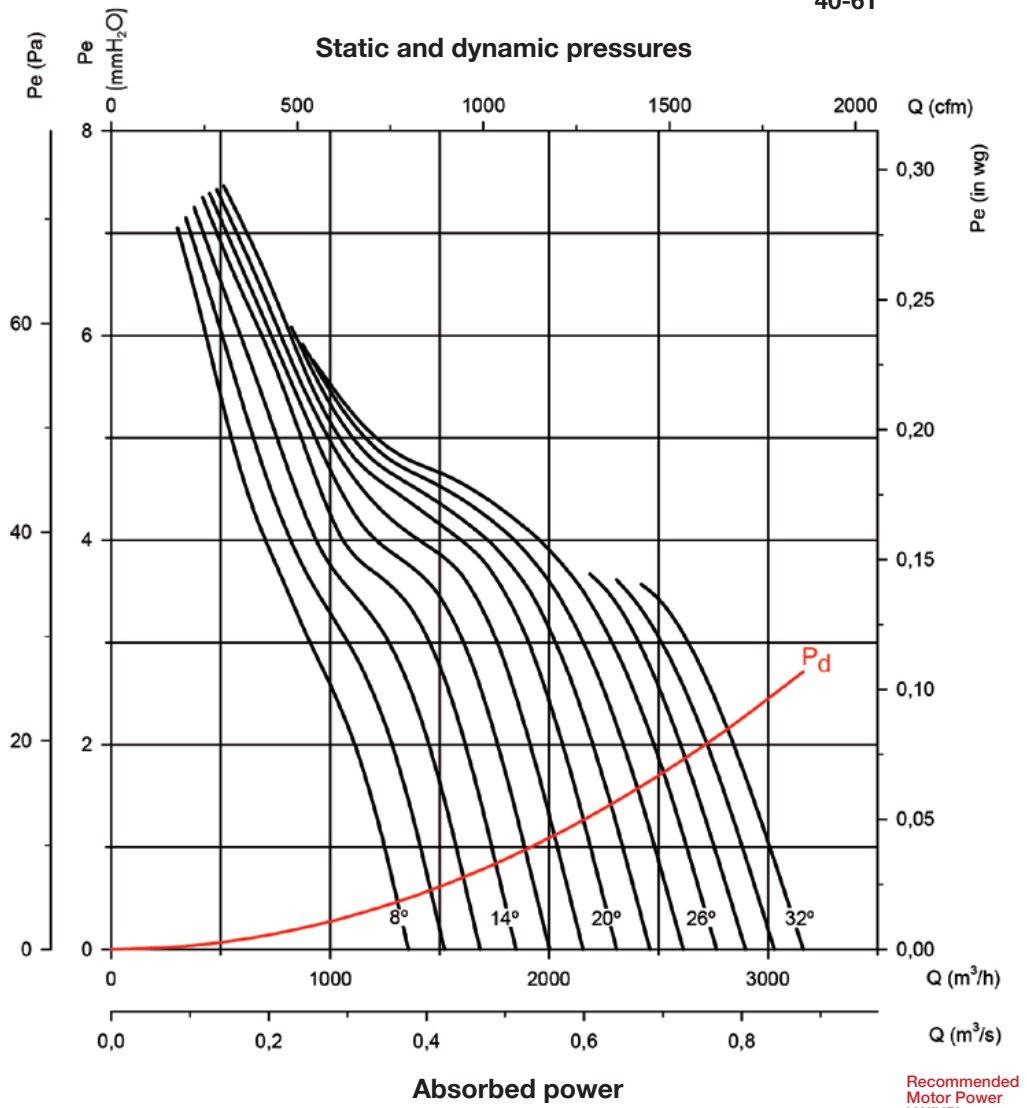

Recommended
Motor Power
kW(HP)

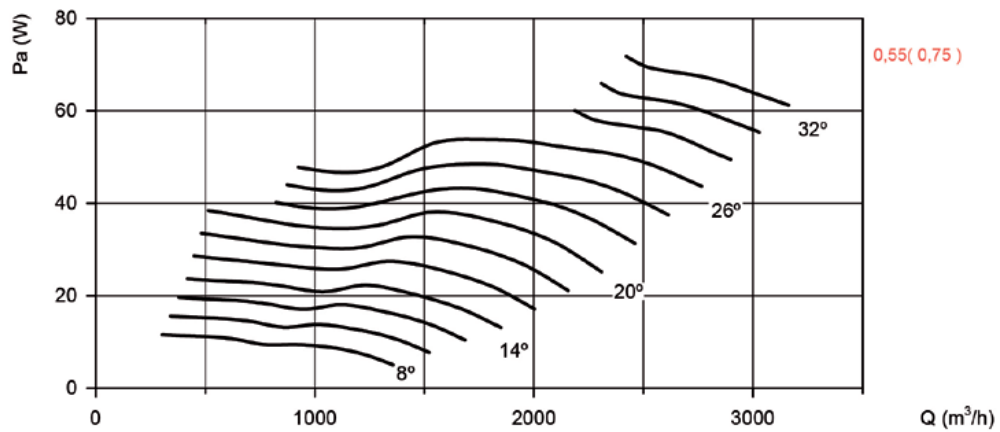

Characteristic curves

Q= Flow rate in m³/h, m³/s and cfm.

Pe= Static pressure in mm H₂O, Pa and inwg.

45-4T

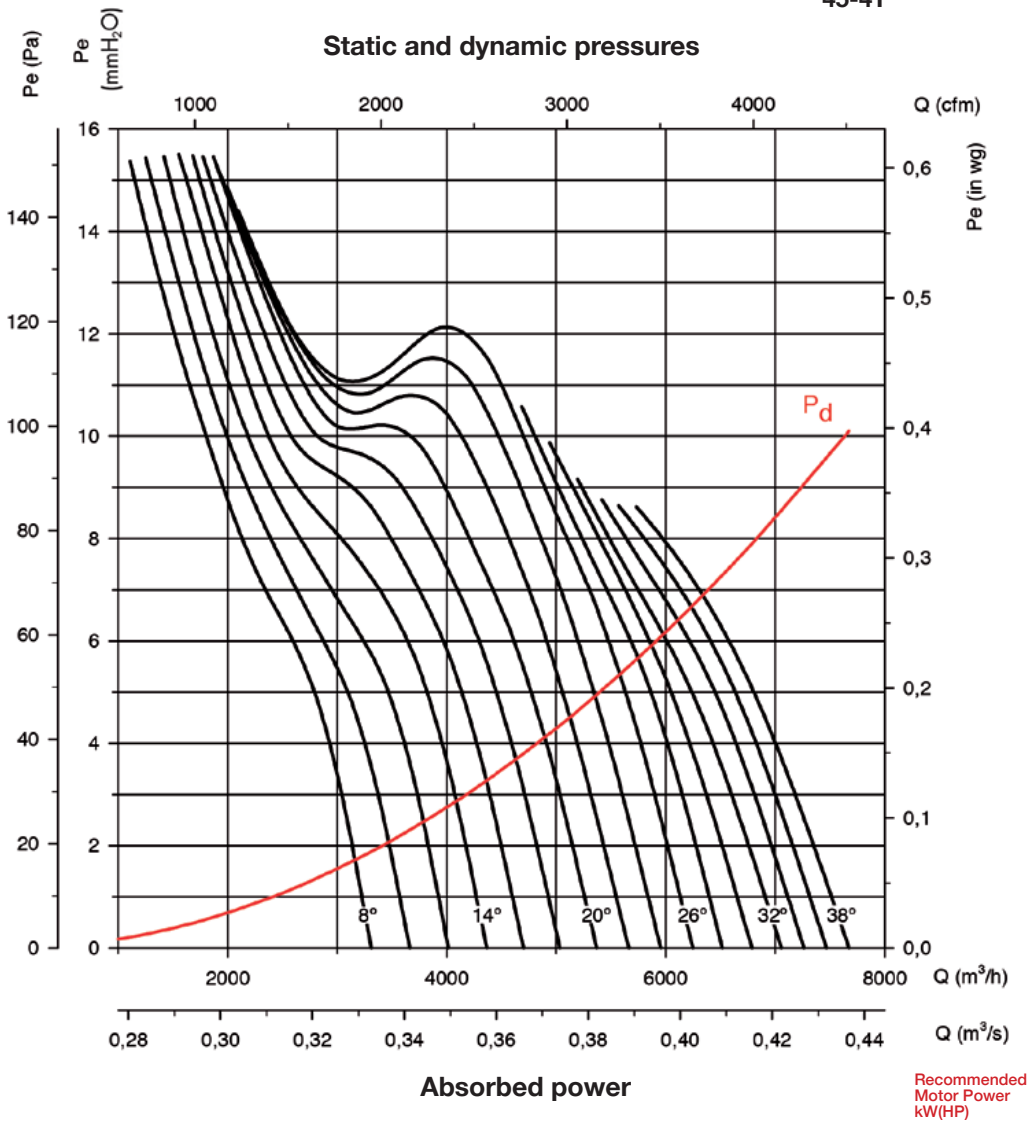

Recommended
Motor Power
kW(HP)

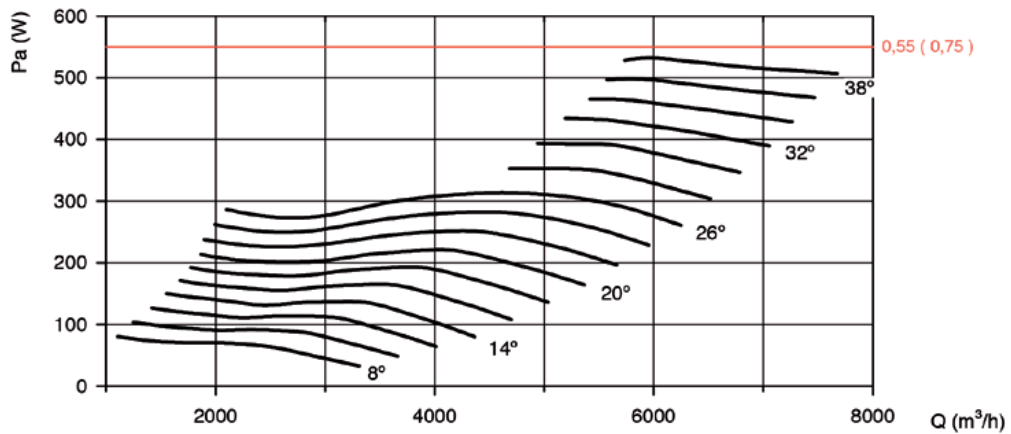

Characteristic curves

Q= Flow rate in m³/h, m³/s and cfm.

Pe= Static pressure in mm H₂O, Pa and inwg.

45-6T

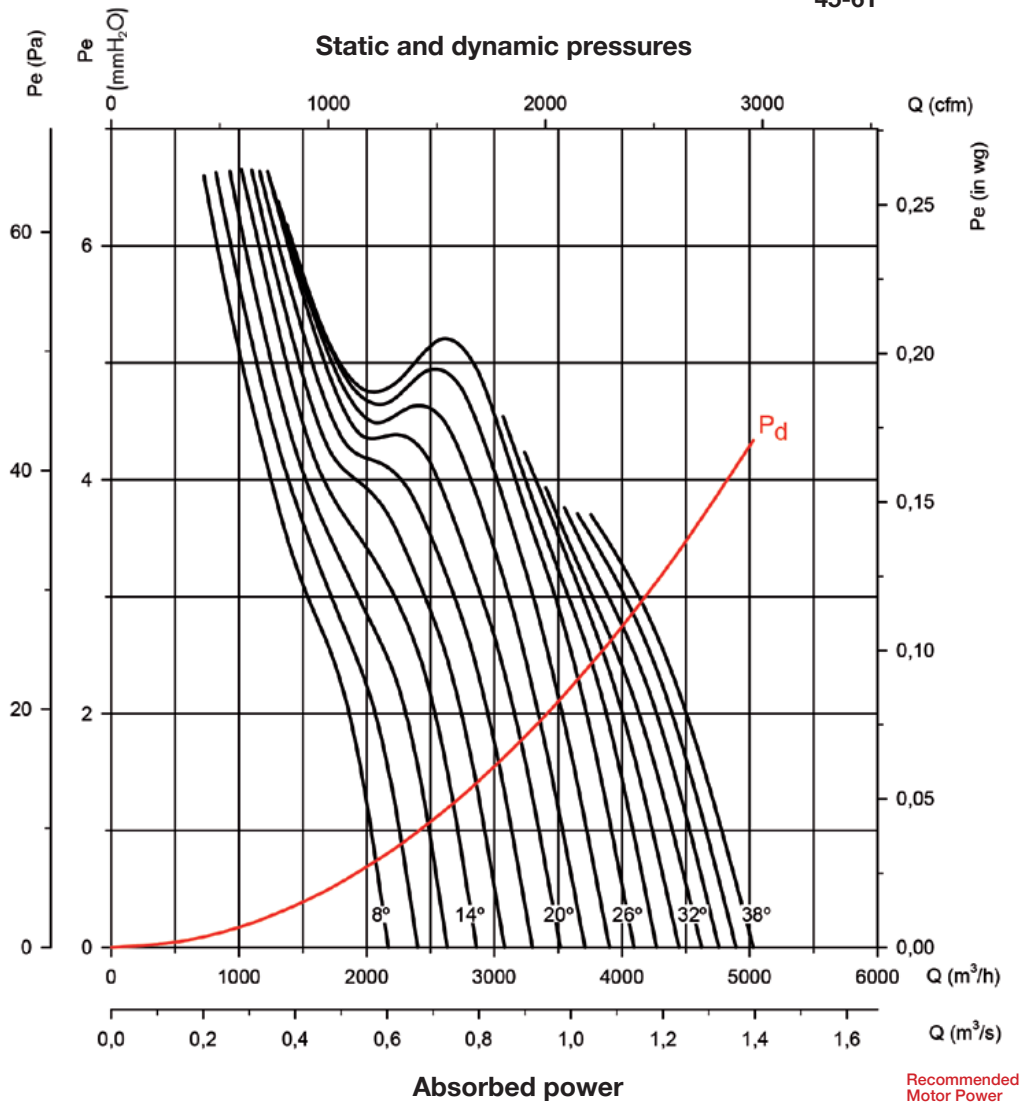

Recommended
Motor Power
kW(HP)

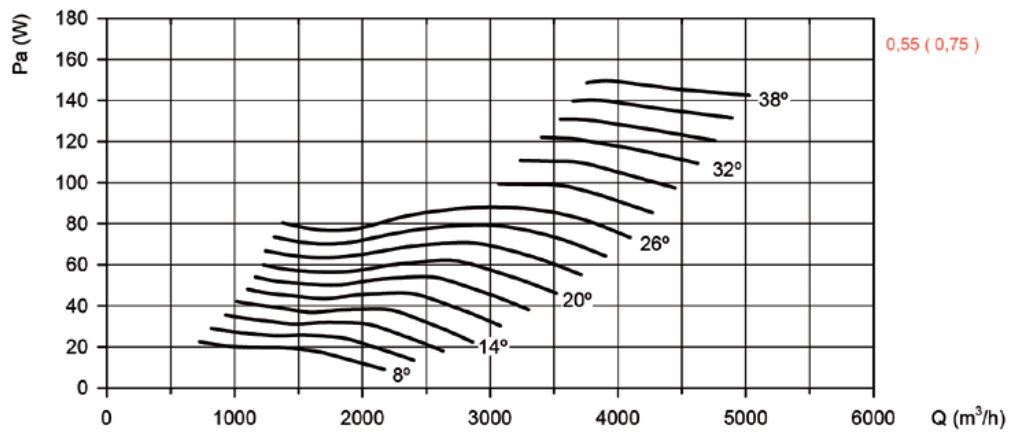

Characteristic curves

Q= Flow rate in m³/h, m³/s and cfm.

Pe= Static pressure in mm H₂O, Pa and inwg.

50-4T

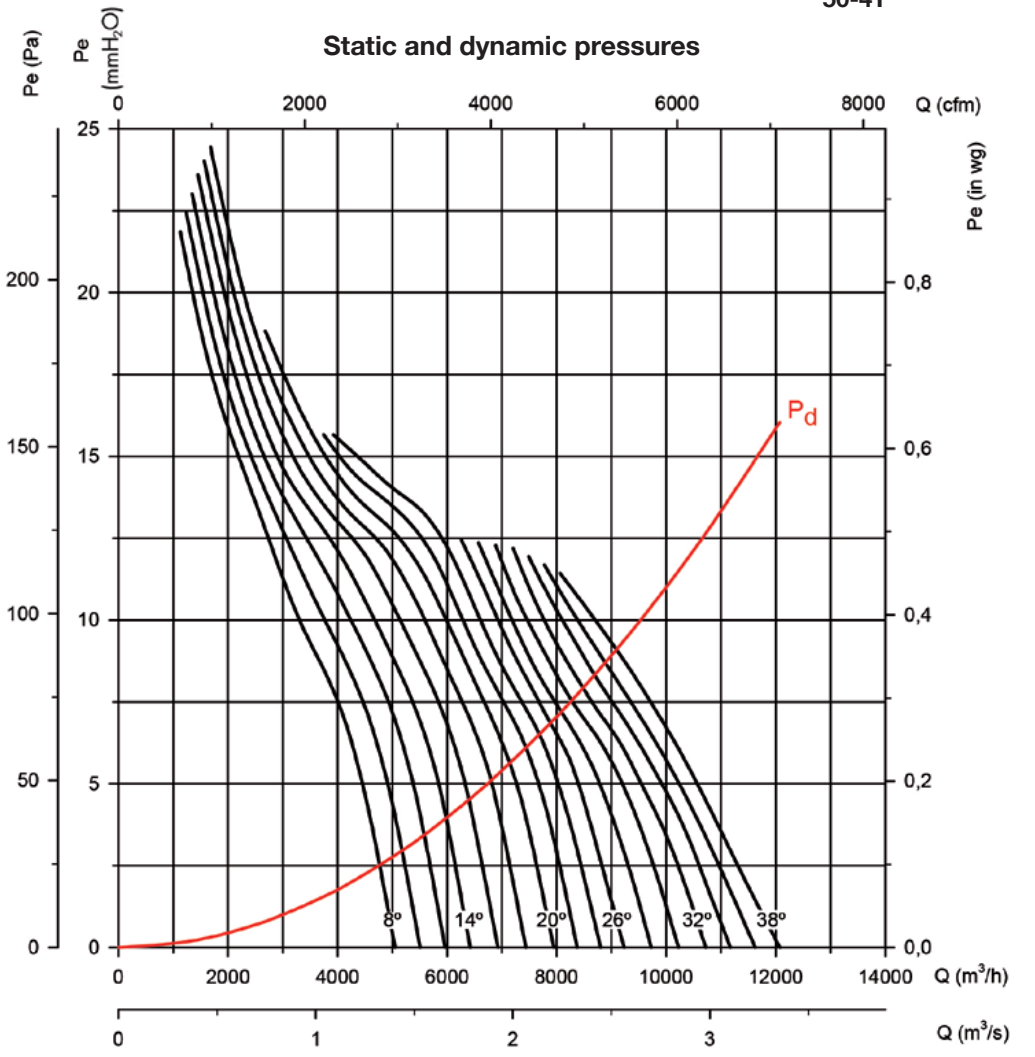

Absorbed power

Recommended Motor Power kW(HP)

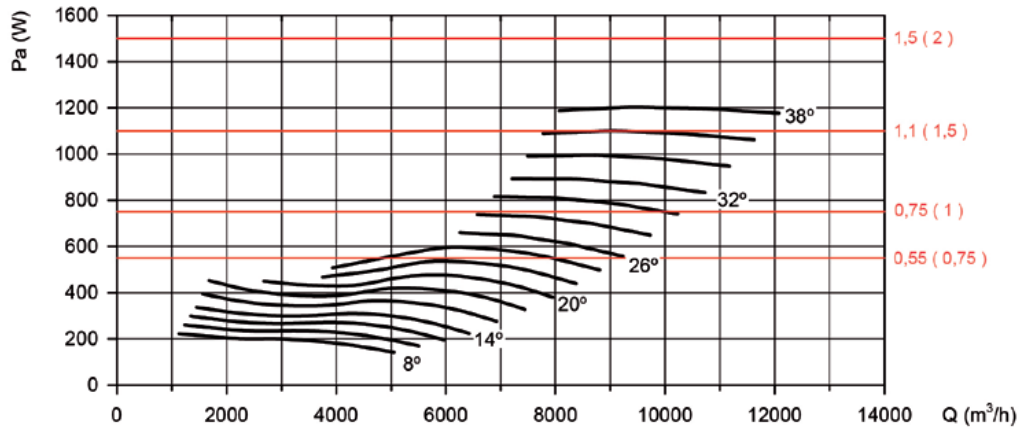

Characteristic curves

Q= Flow rate in m³/h, m³/s and cfm.

Pe= Static pressure in mm H₂O, Pa and inwg.

50-6T

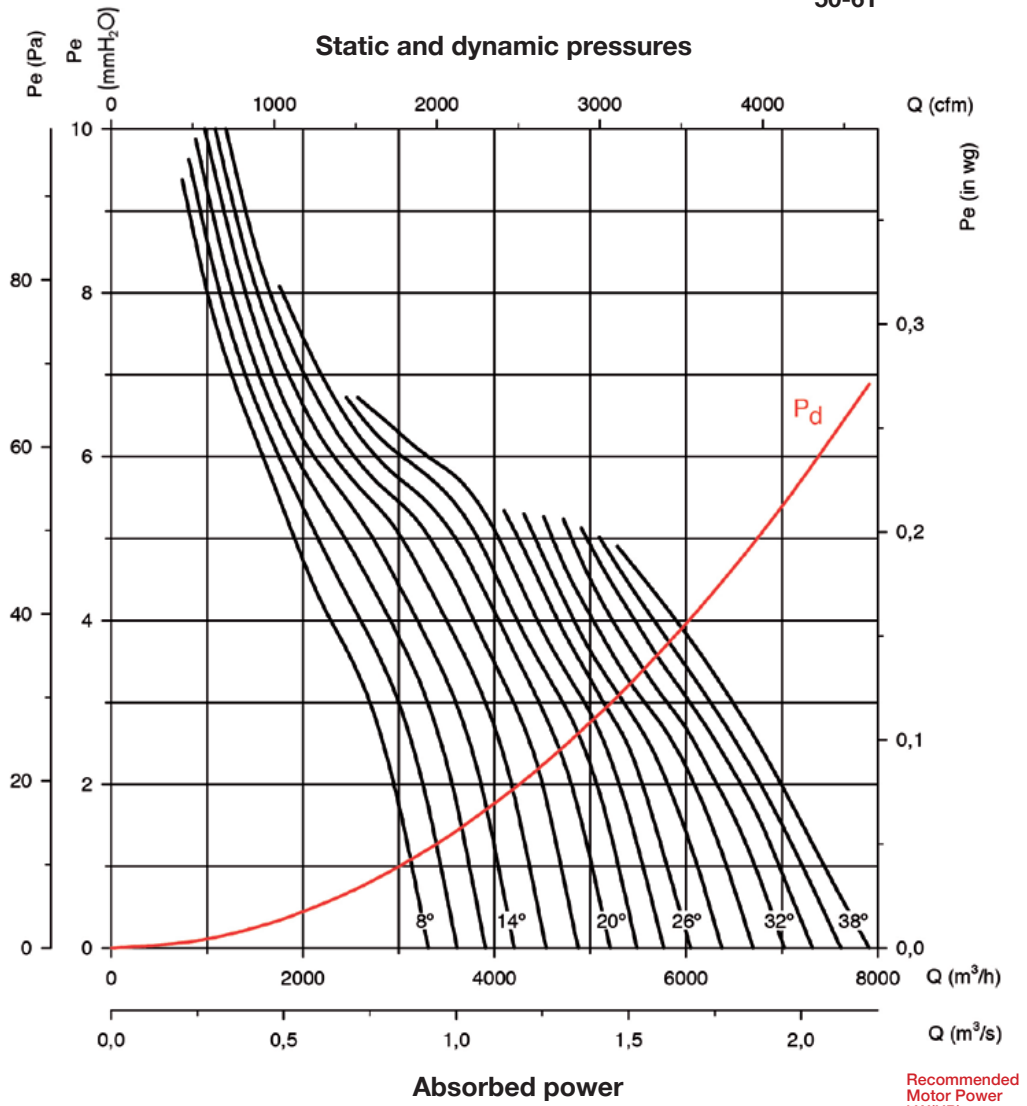

Recommended
Motor Power
kW(HP)

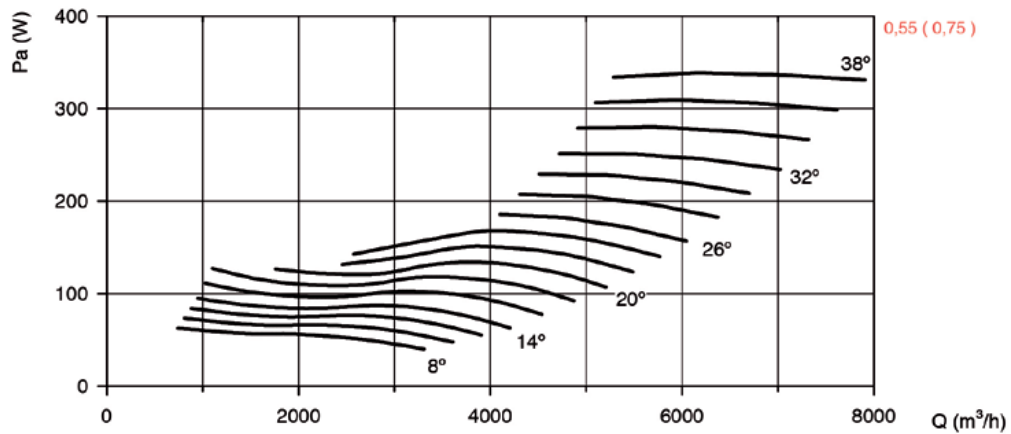

Characteristic curves

Q= Flow rate in m³/h, m³/s and cfm.

Pe= Static pressure in mm H₂O, Pa and inwg.

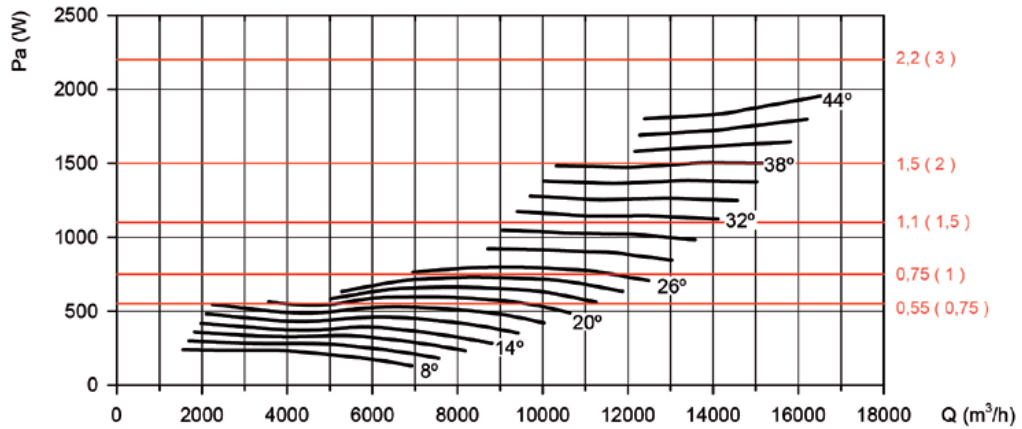
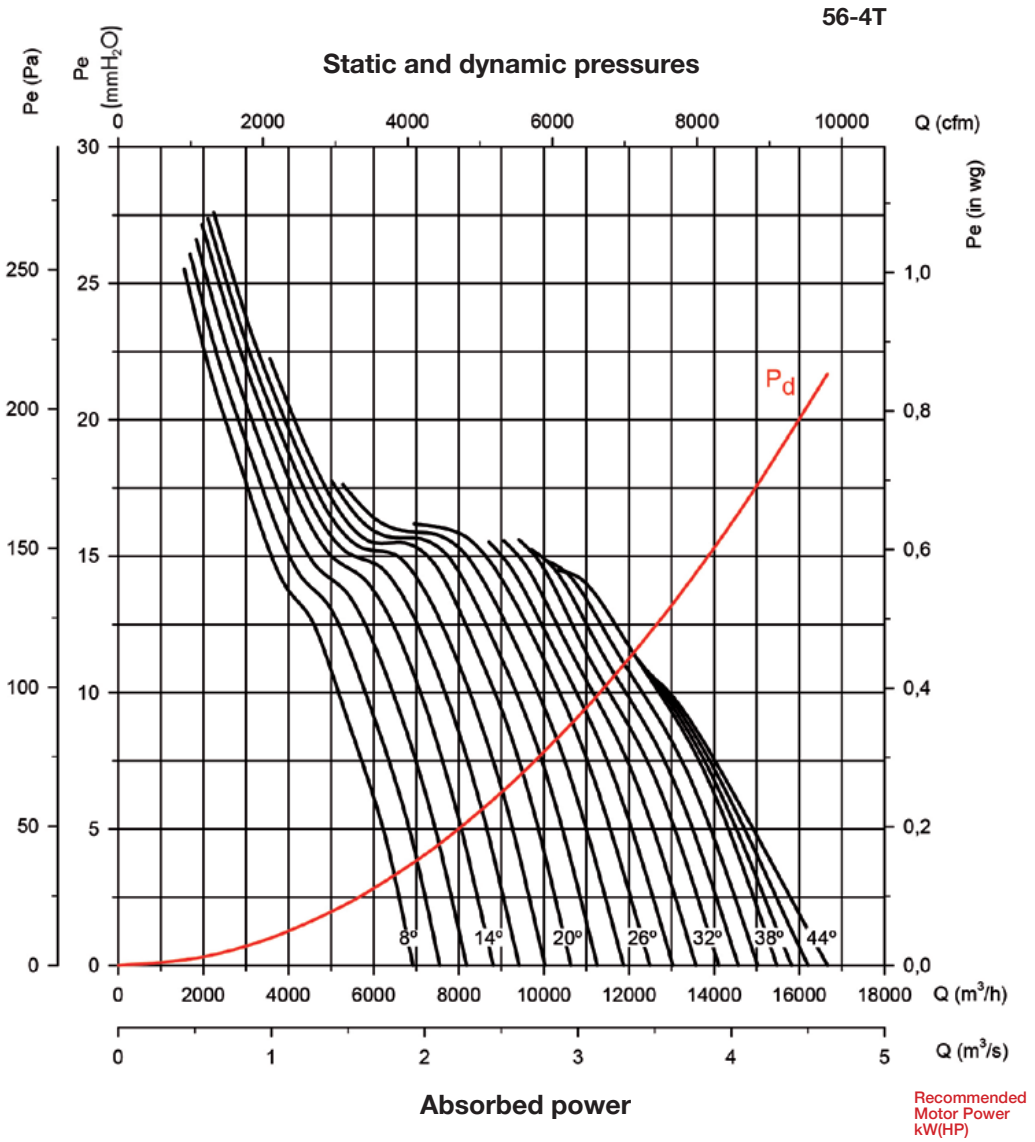

Characteristic curves

Q= Flow rate in m³/h, m³/s and cfm.

Pe= Static pressure in mm H₂O, Pa and inwg.

56-6T

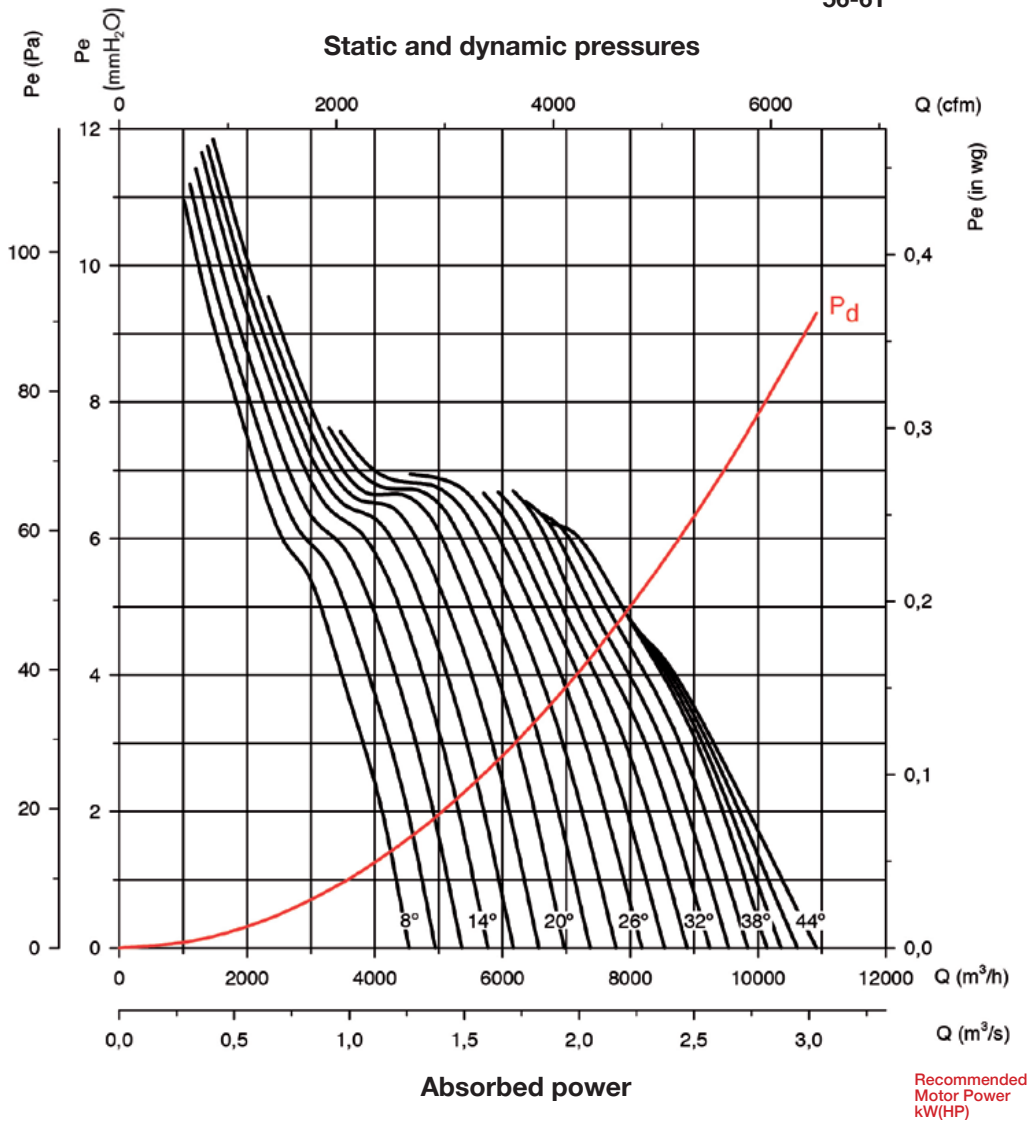

Absorbed power

Recommended
Motor Power
kW(HP)

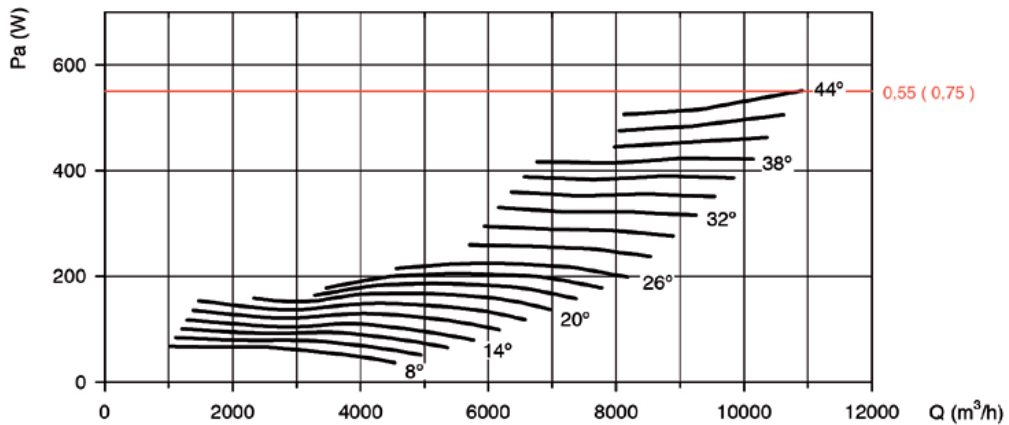

Characteristic curves

Q= Flow rate in m³/h, m³/s and cfm.

Pe= Static pressure in mm H₂O, Pa and inwg.

63-4T

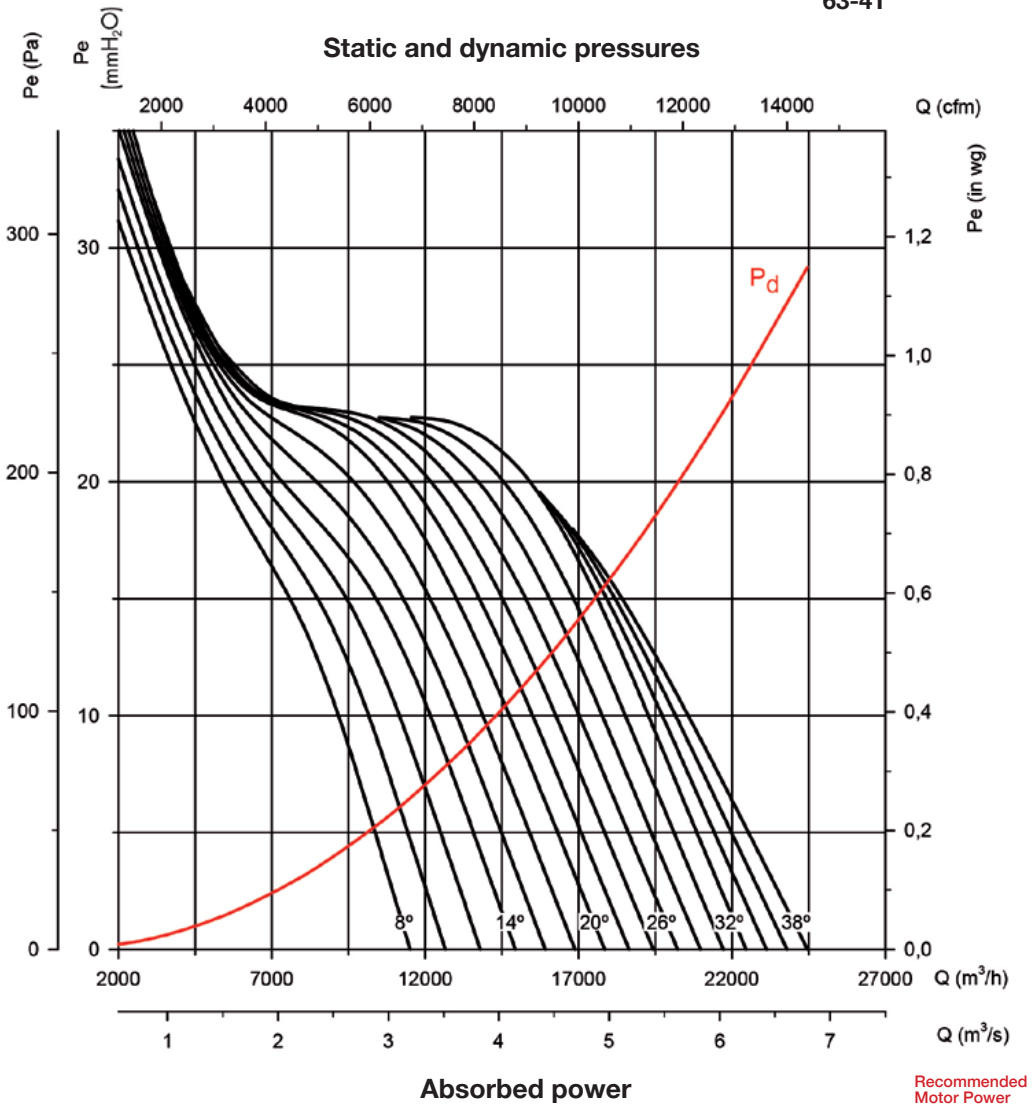

Recommended Motor Power kW(HP)

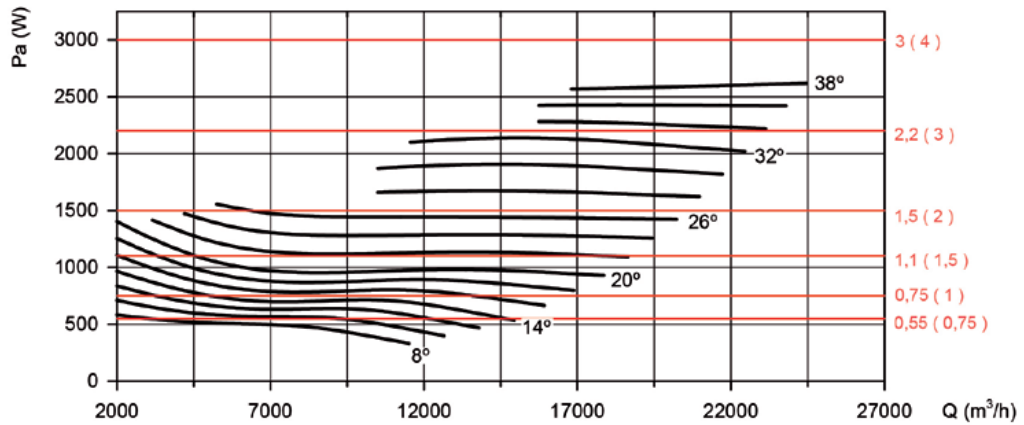

Characteristic curves

Q= Flow rate in m³/h, m³/s and cfm.

Pe= Static pressure in mm H₂O, Pa and inwg.

63-6T

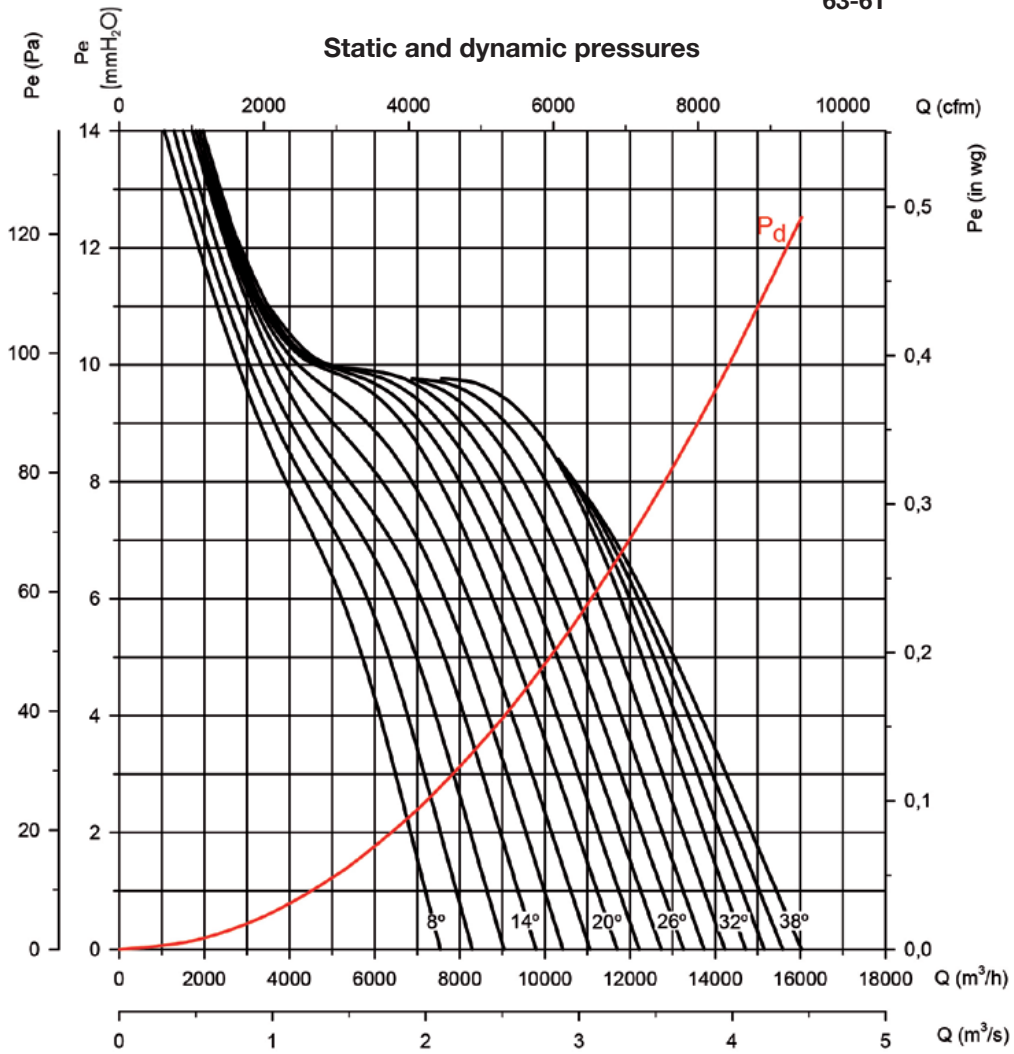

Absorbed power

Recommended
Motor Power
kW(HP)

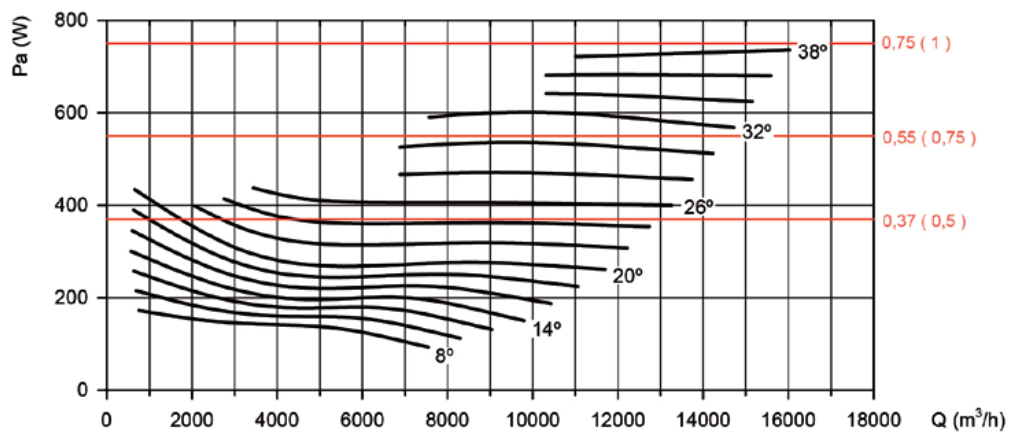

Characteristic curves

Q= Flow rate in m³/h, m³/s and cfm.

Pe= Static pressure in mm H₂O, Pa and inwg.

71-4T

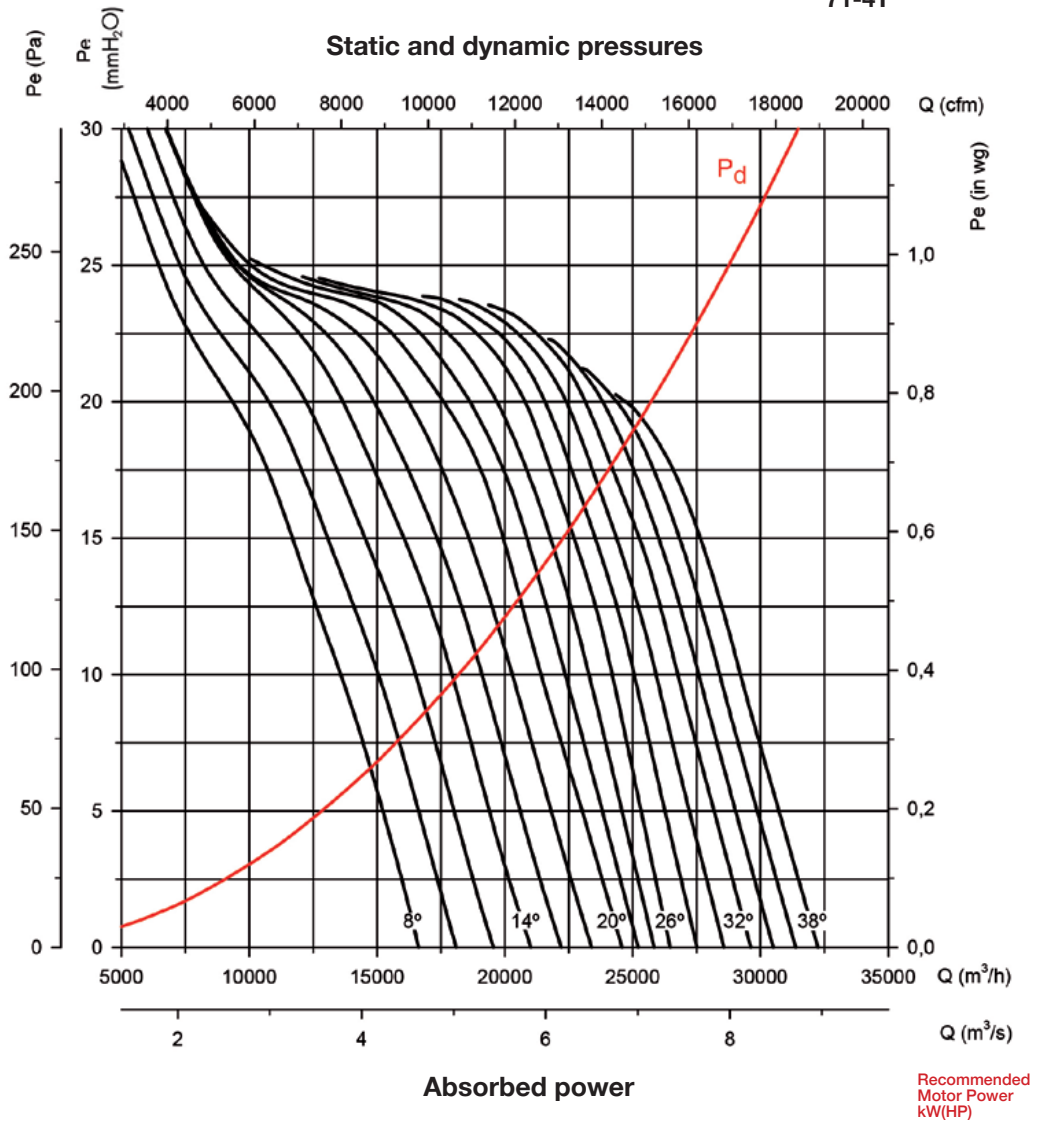

Recommended Motor Power kW(HP)

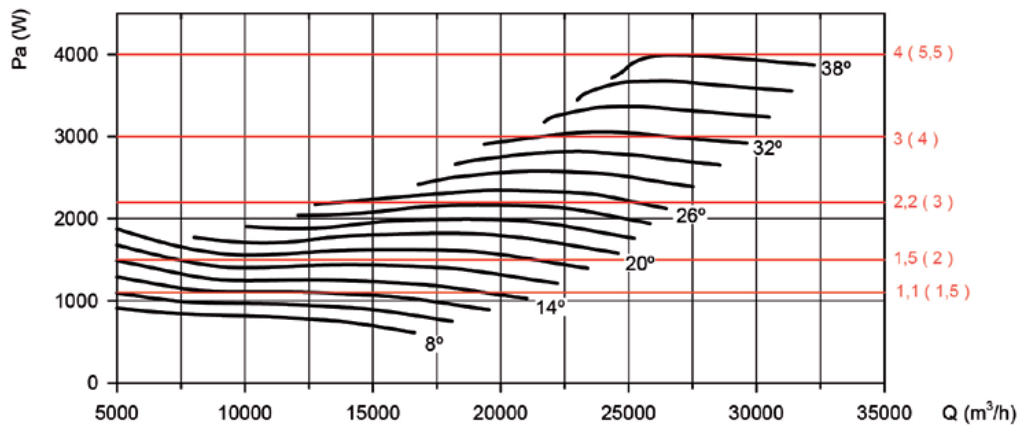

Characteristic curves

Q= Flow rate in m³/h, m³/s and cfm.

Pe= Static pressure in mm H₂O, Pa and inwg.

71-6T

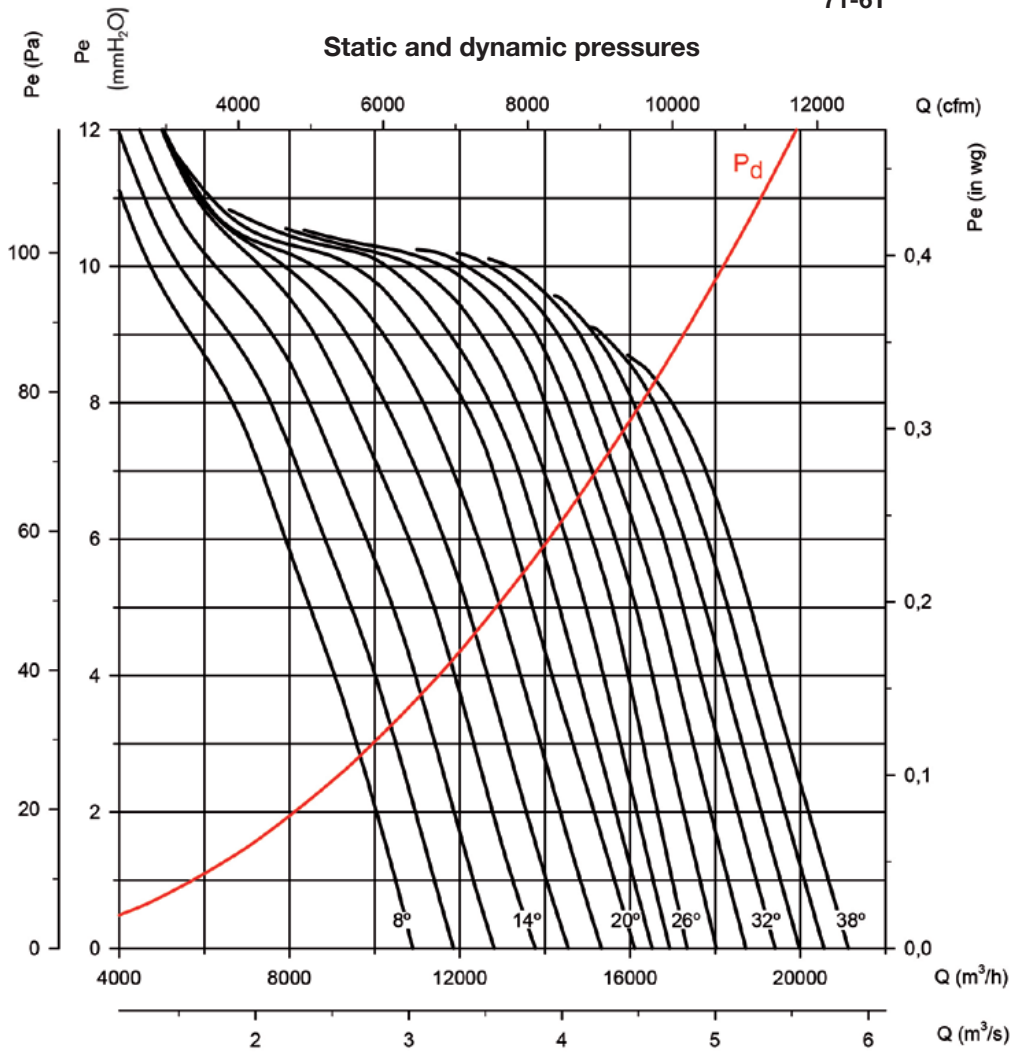

Absorbed power

Recommended
Motor Power
kW(HP)

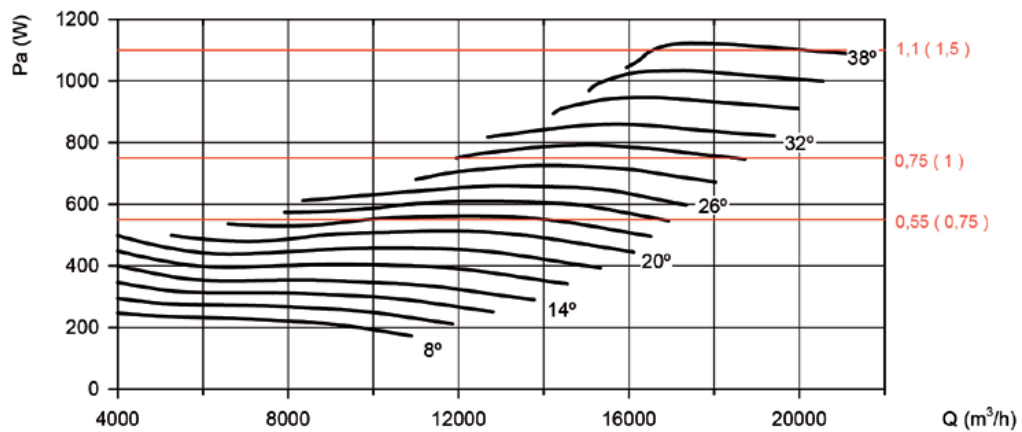

Characteristic curves

Q= Flow rate in m³/h, m³/s and cfm.

Pe= Static pressure in mm H₂O, Pa and inwg.

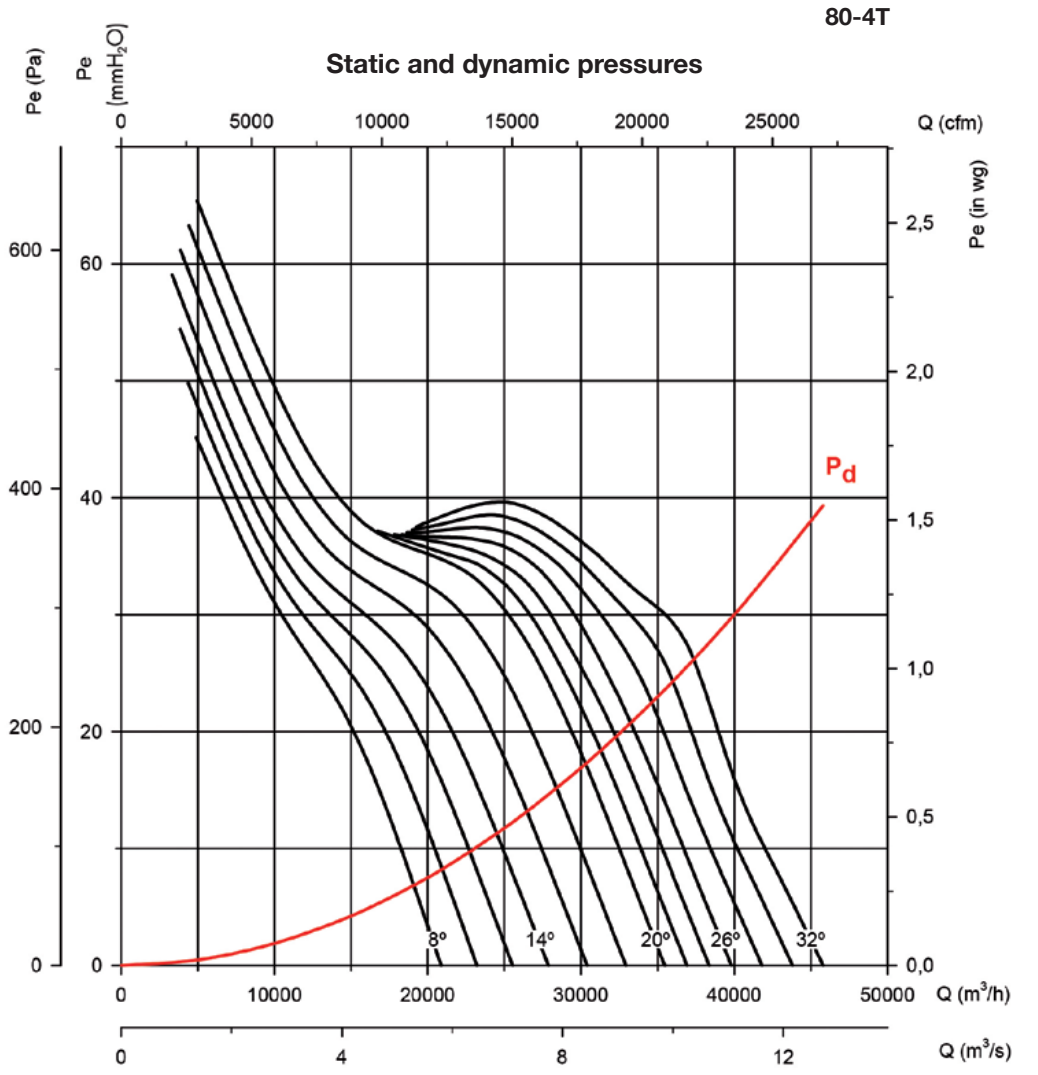

Absorbed power

Recommended
Motor Power
kW(HP)

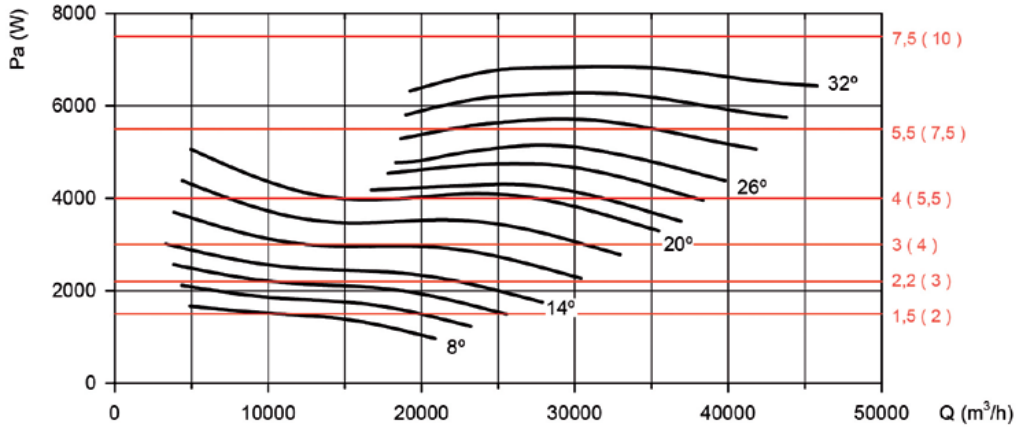

Characteristic curves

Q= Flow rate in m³/h, m³/s and cfm.

Pe= Static pressure in mm H₂O, Pa and inwg.

80-6T

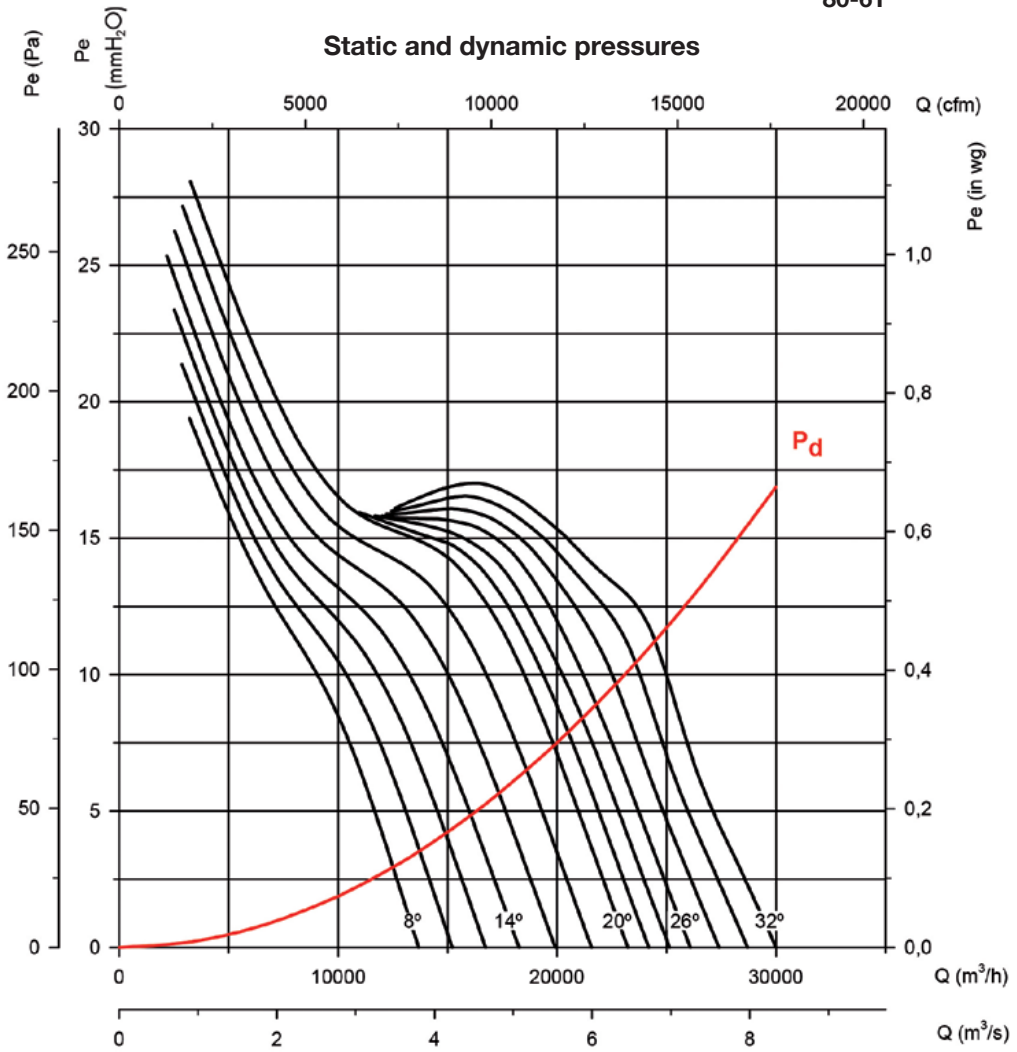

Absorbed power

Recommended
Motor Power
kW(HP)

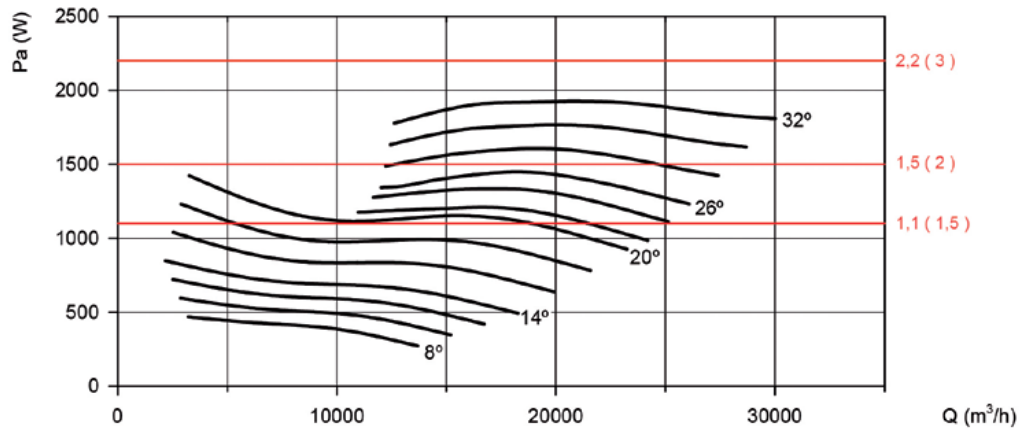

Characteristic curves

Q= Flow rate in m³/h, m³/s and cfm.

Pe= Static pressure in mm H₂O, Pa and inwg.

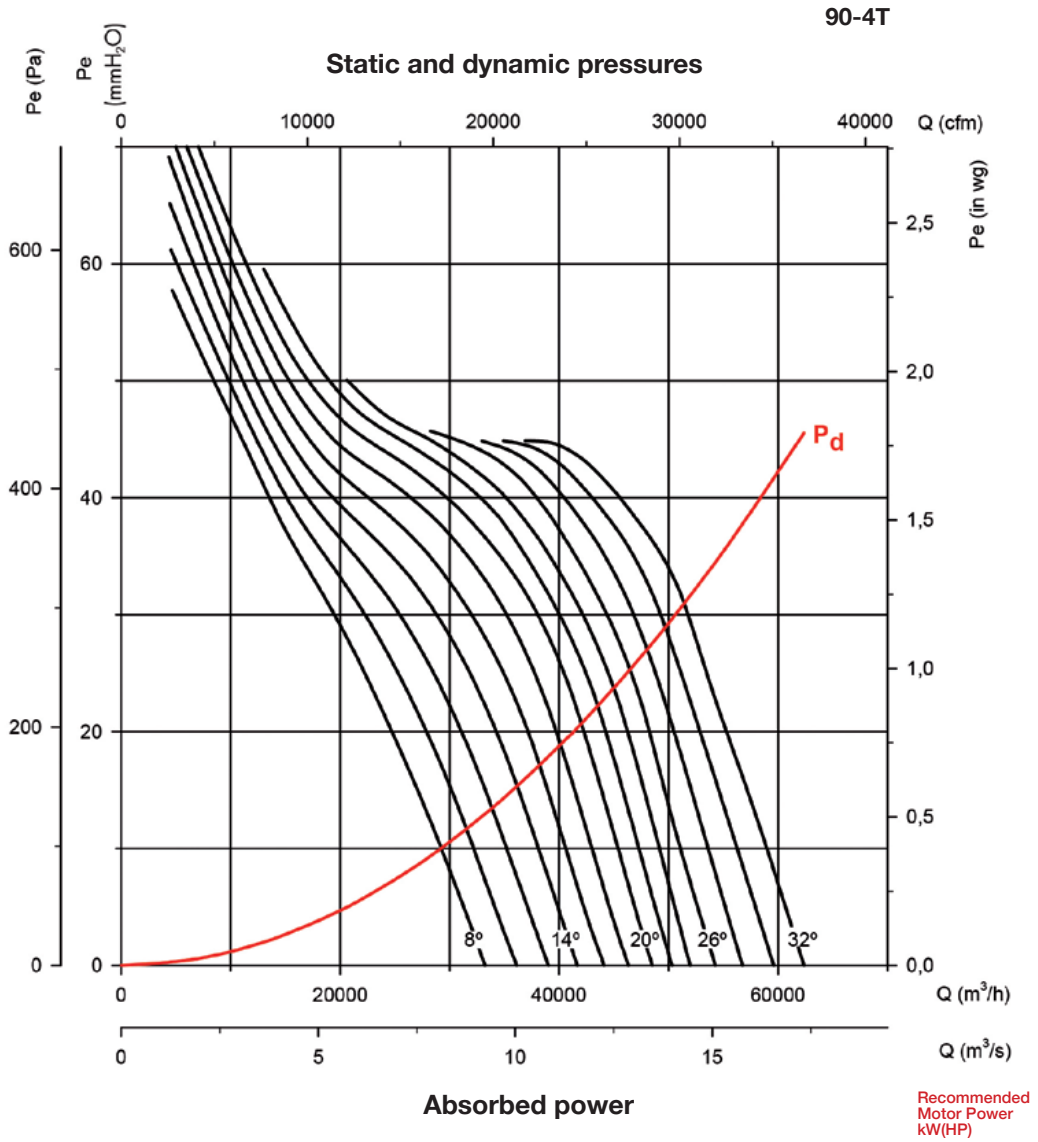

Absorbed power

Recommended Motor Power kW(HP)

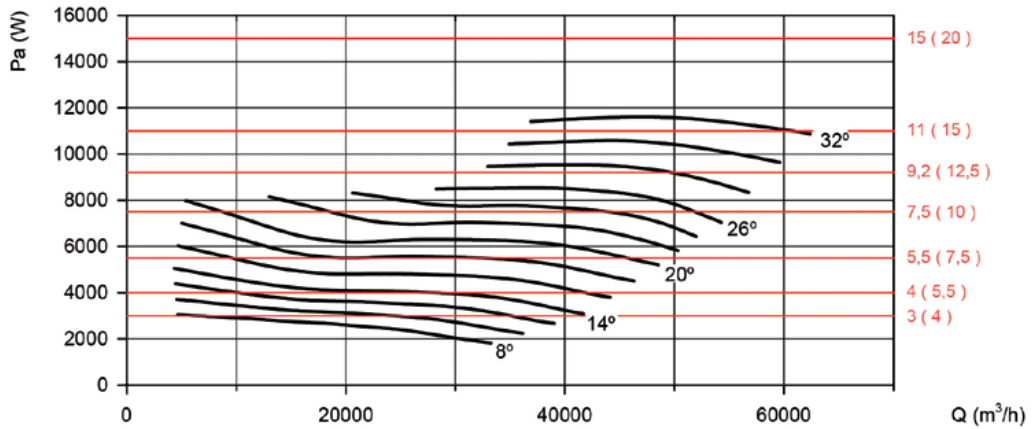

Characteristic curves

Q= Flow rate in m³/h, m³/s and cfm.

Pe= Static pressure in mm H₂O, Pa and inwg.

90-6T

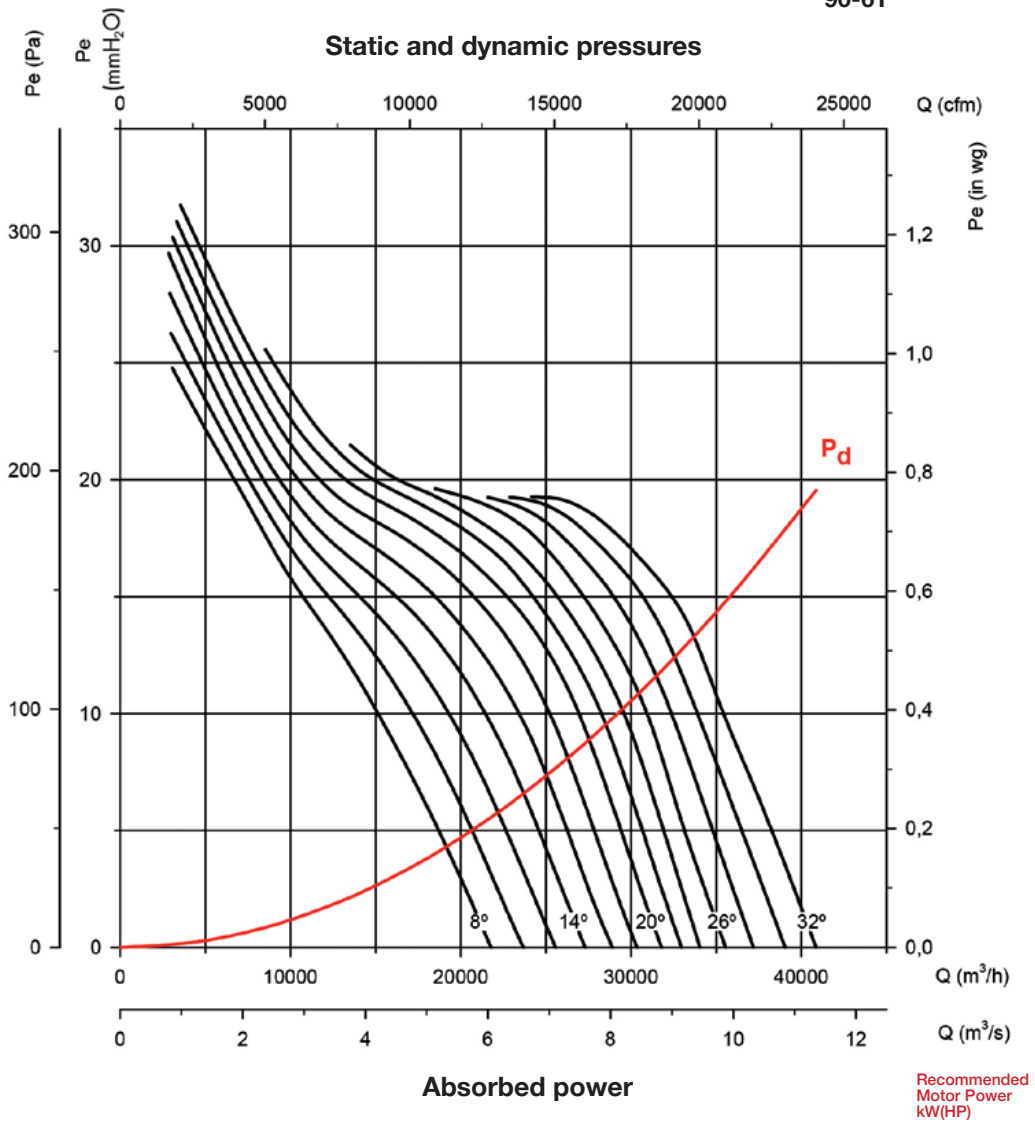

Absorbed power

Recommended
Motor Power
kW(HP)

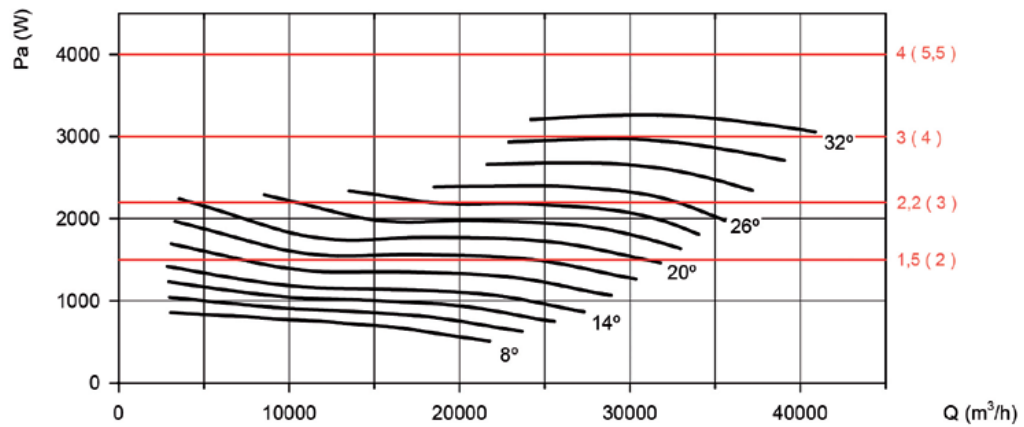

Characteristic curves

Q= Flow rate in m³/h, m³/s and cfm.

Pe= Static pressure in mm H₂O, Pa and inwg.

100-4T/6

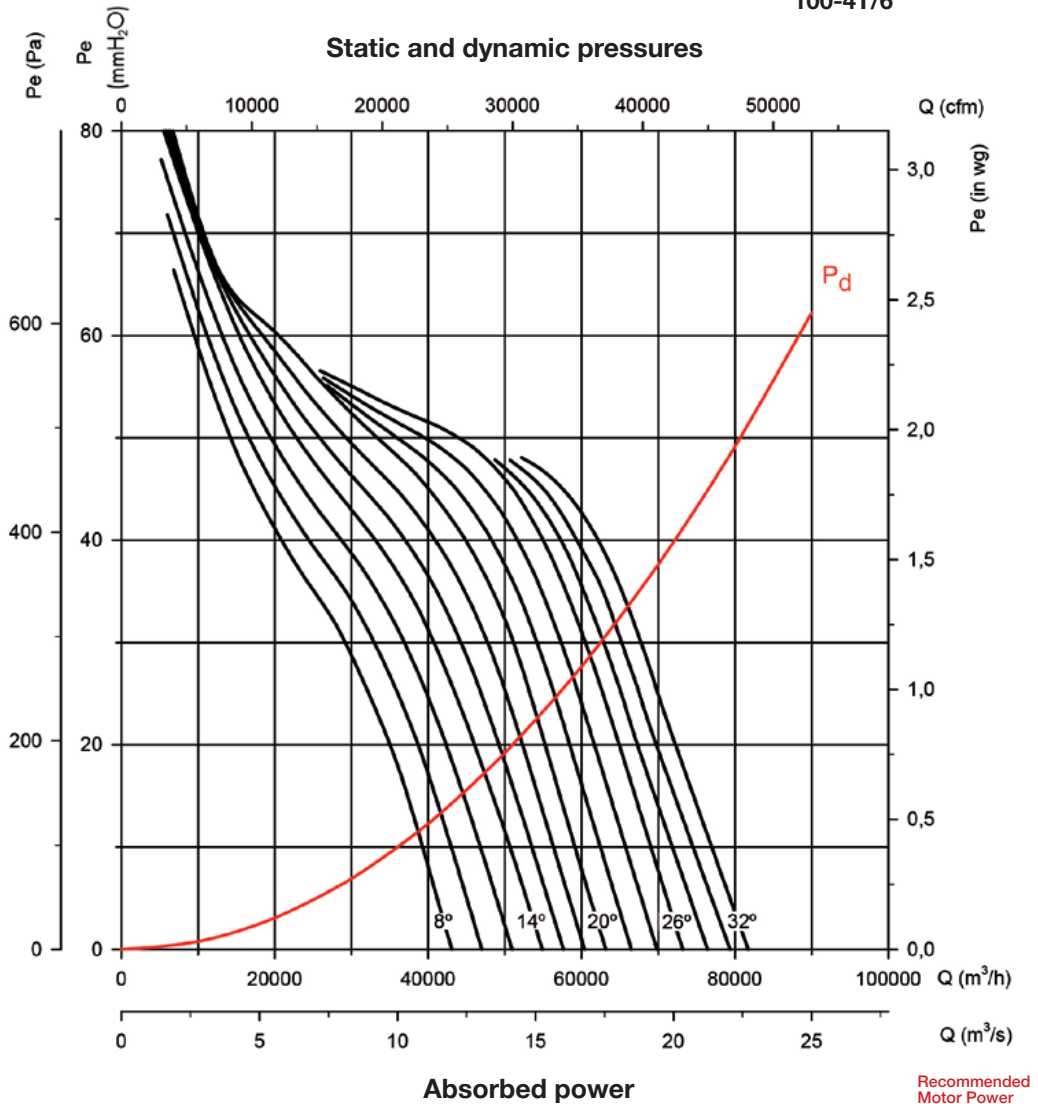

Absorbed power

Recommended Motor Power kW(HP)

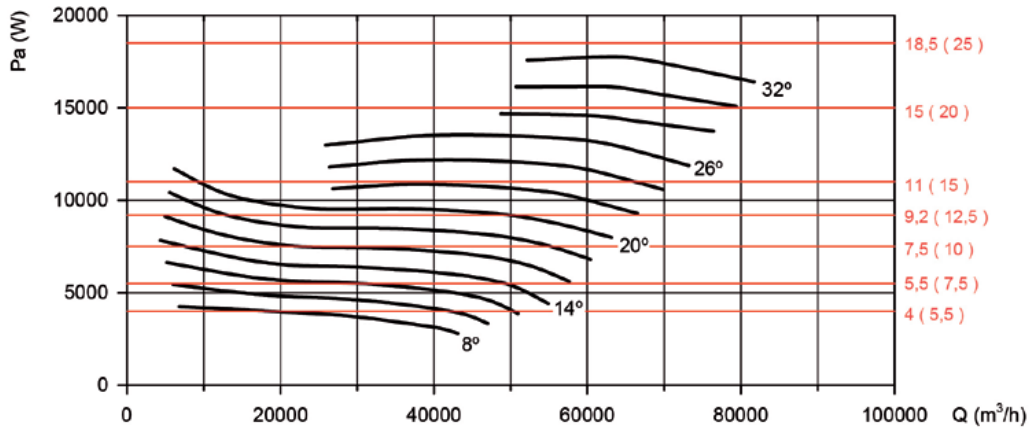

Characteristic curves

Q= Flow rate in m³/h, m³/s and cfm.

Pe= Static pressure in mm H₂O, Pa and inwg.

100-6T/6

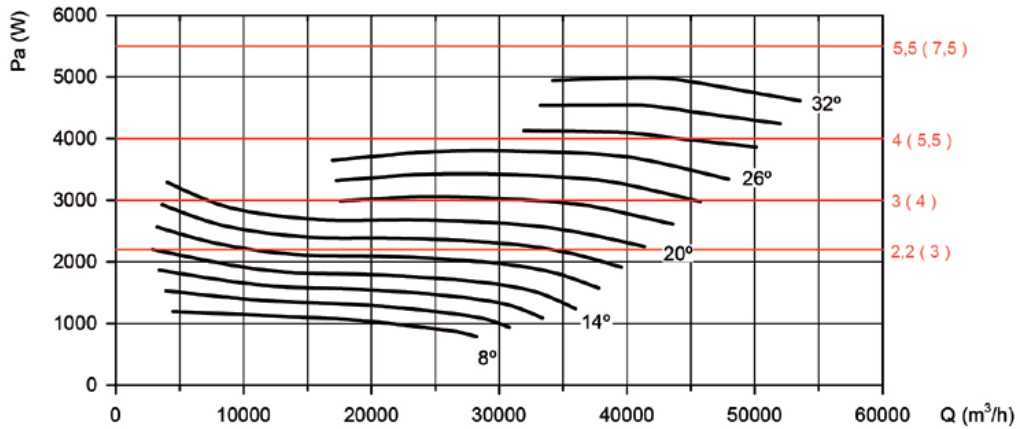
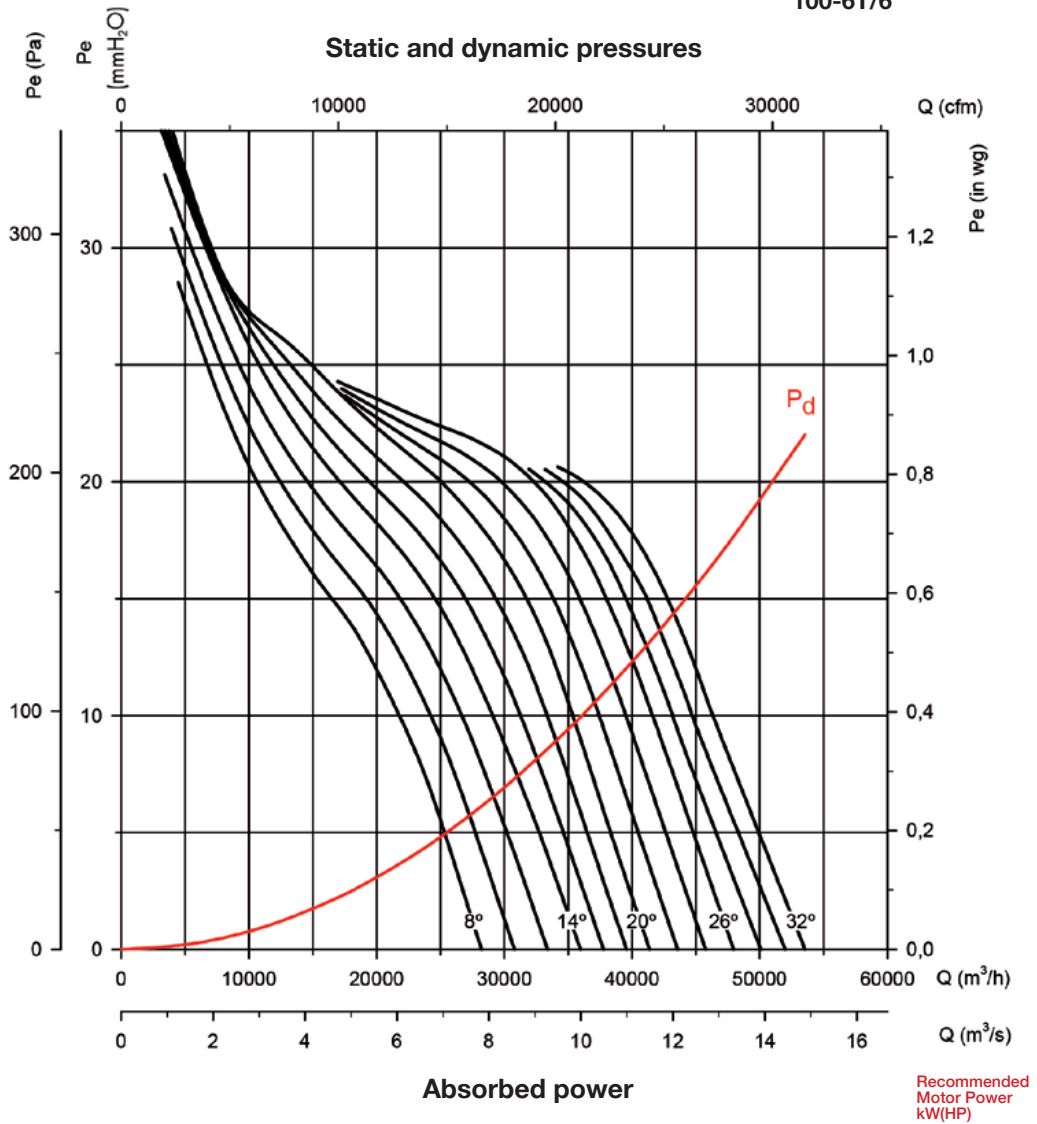

Characteristic curves

Q= Flow rate in m³/h, m³/s and cfm.

Pe= Static pressure in mm H₂O, Pa and inwg.

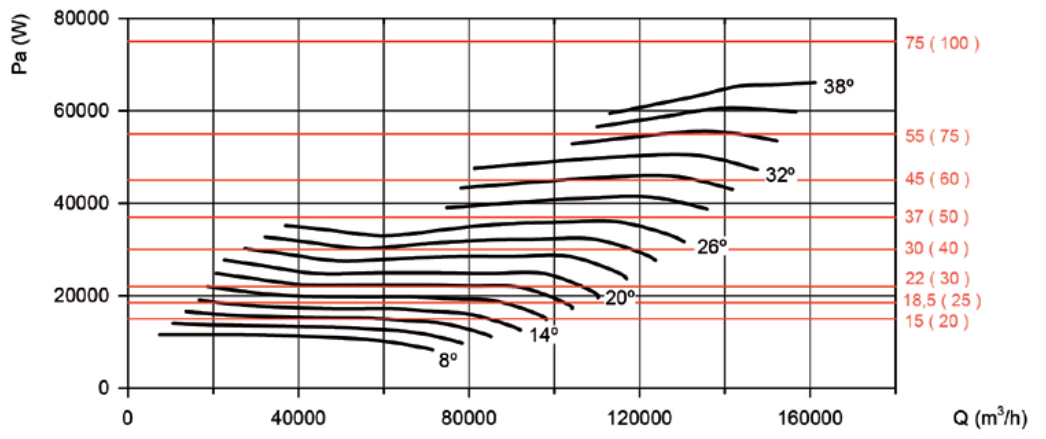
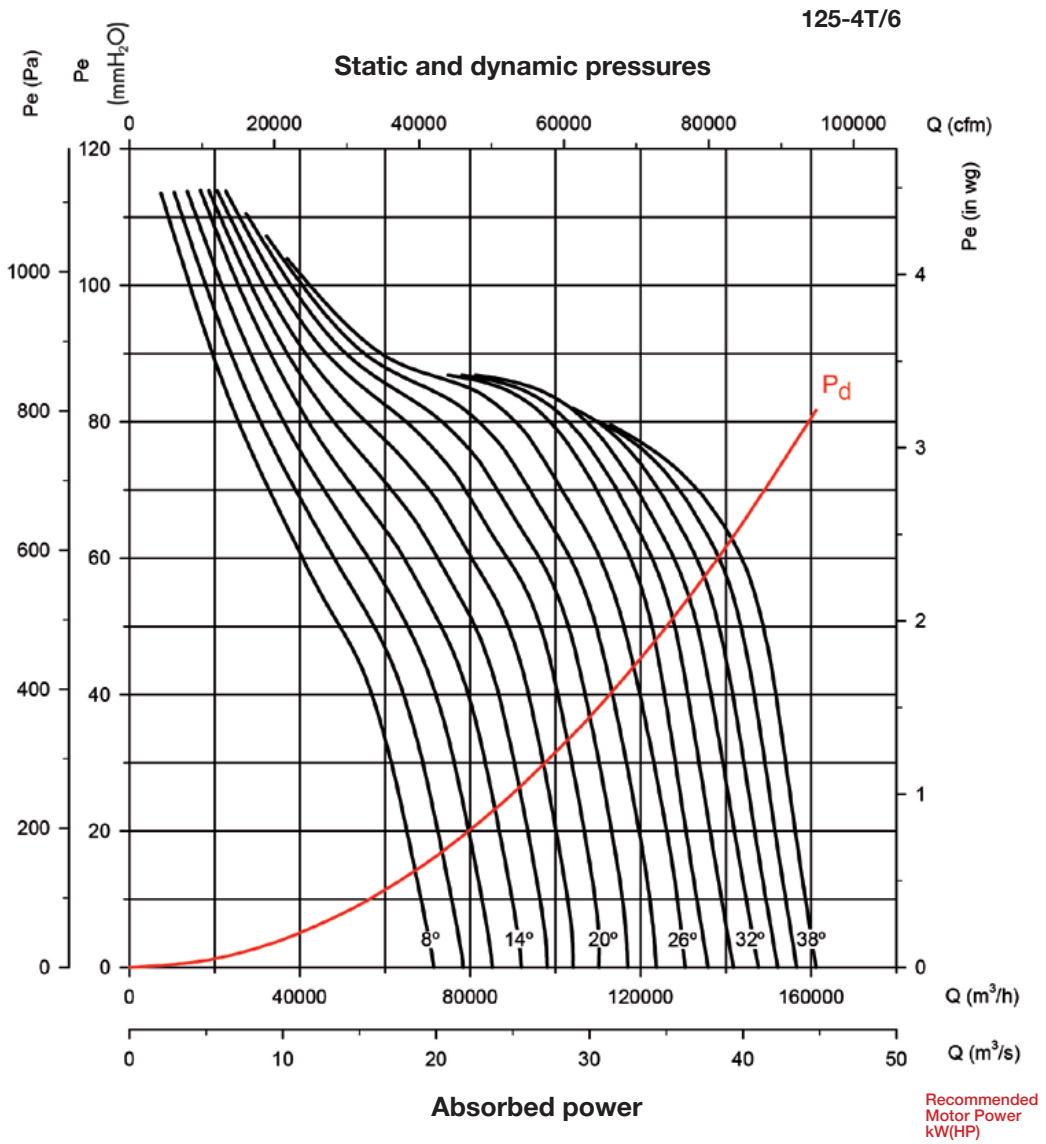

Characteristic curves

Q= Flow rate in m³/h, m³/s and cfm.

Pe= Static pressure in mm H₂O, Pa and inwg.

125-4T/9

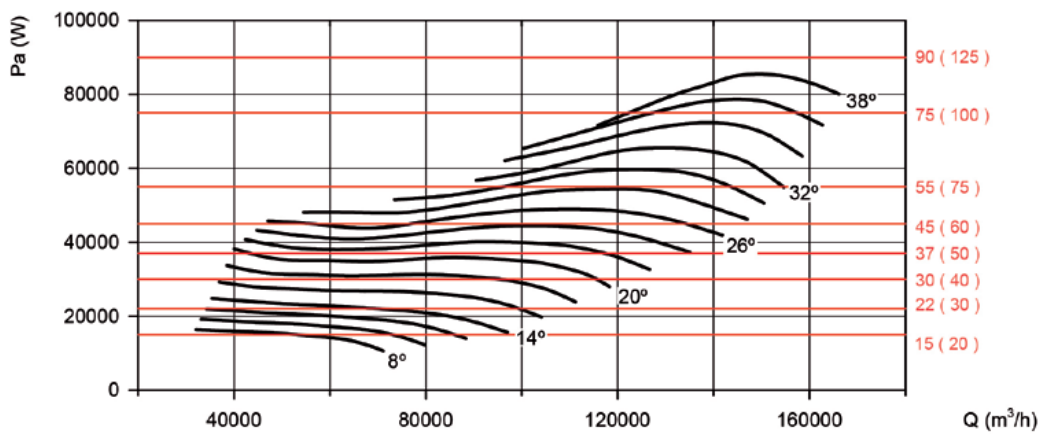
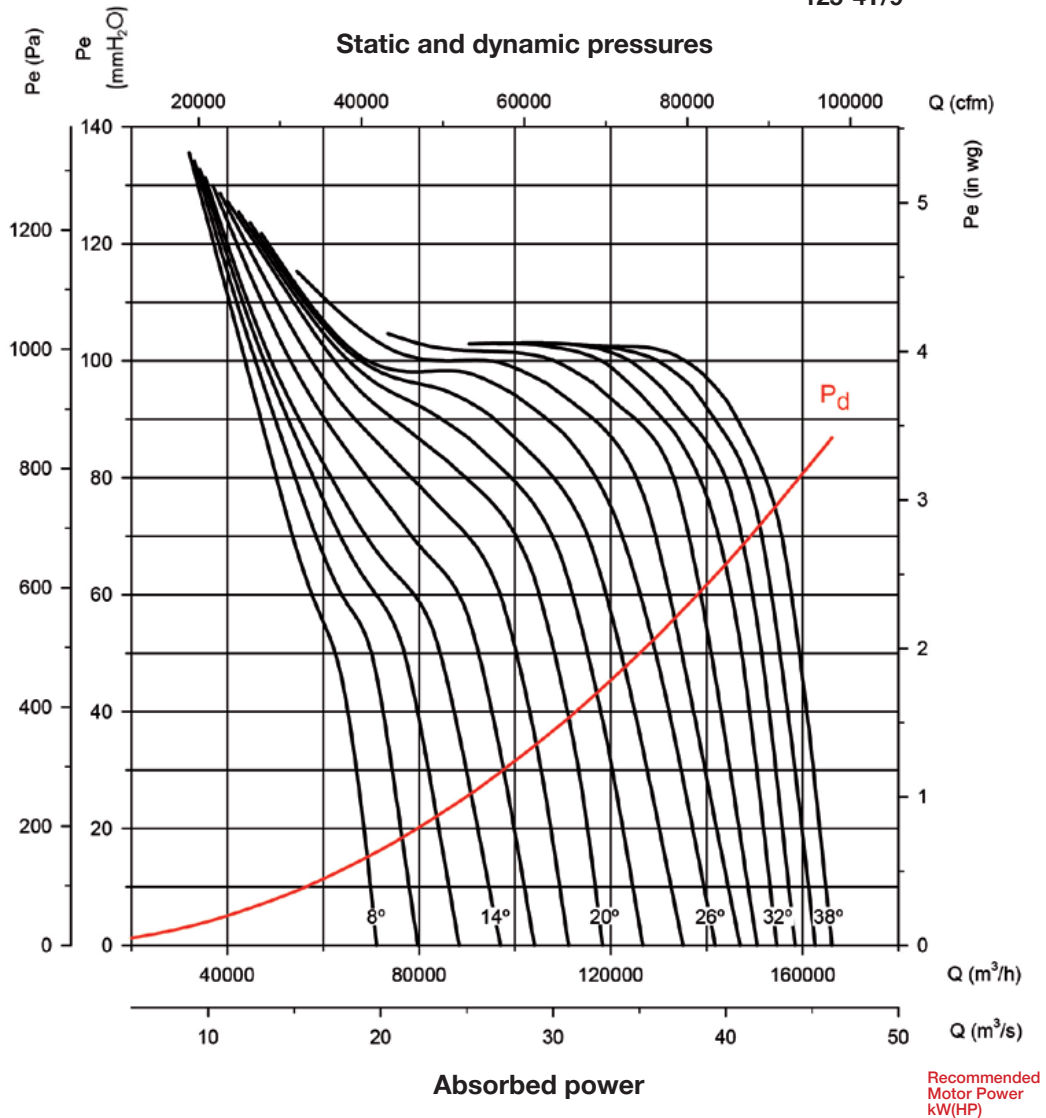

Characteristic curves

Q= Flow rate in m³/h, m³/s and cfm.

Pe= Static pressure in mm H₂O, Pa and inwg.

125-6T/6

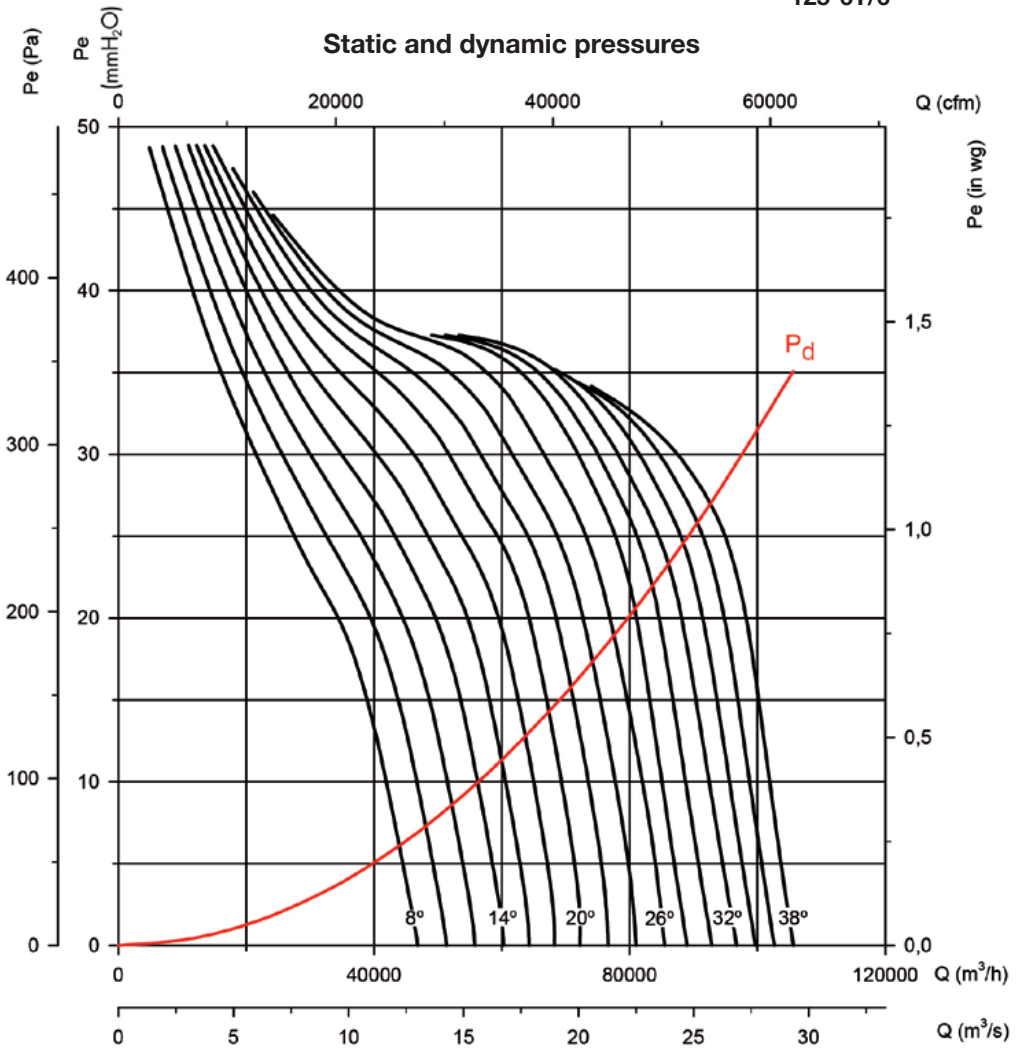

Absorbed power

Recommended Motor Power kW(HP)

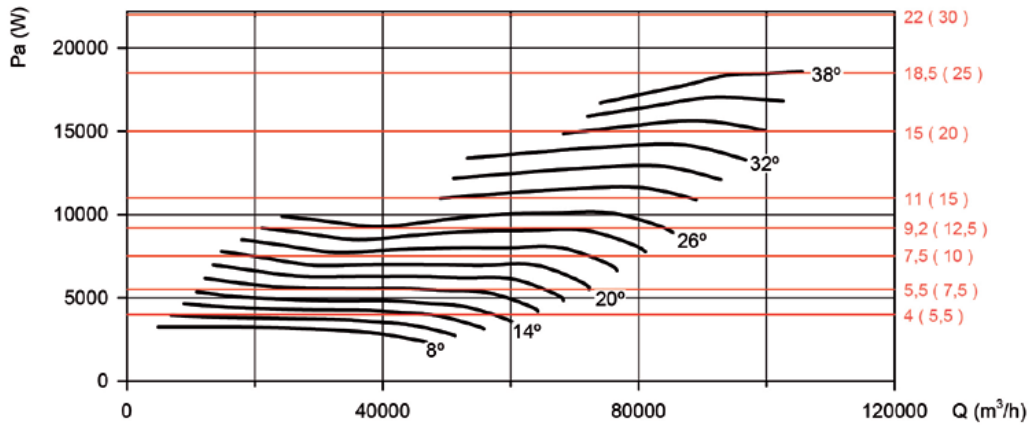

Characteristic curves

Q= Flow rate in m³/h, m³/s and cfm.

Pe= Static pressure in mm H₂O, Pa and inwg.

125-6T/9

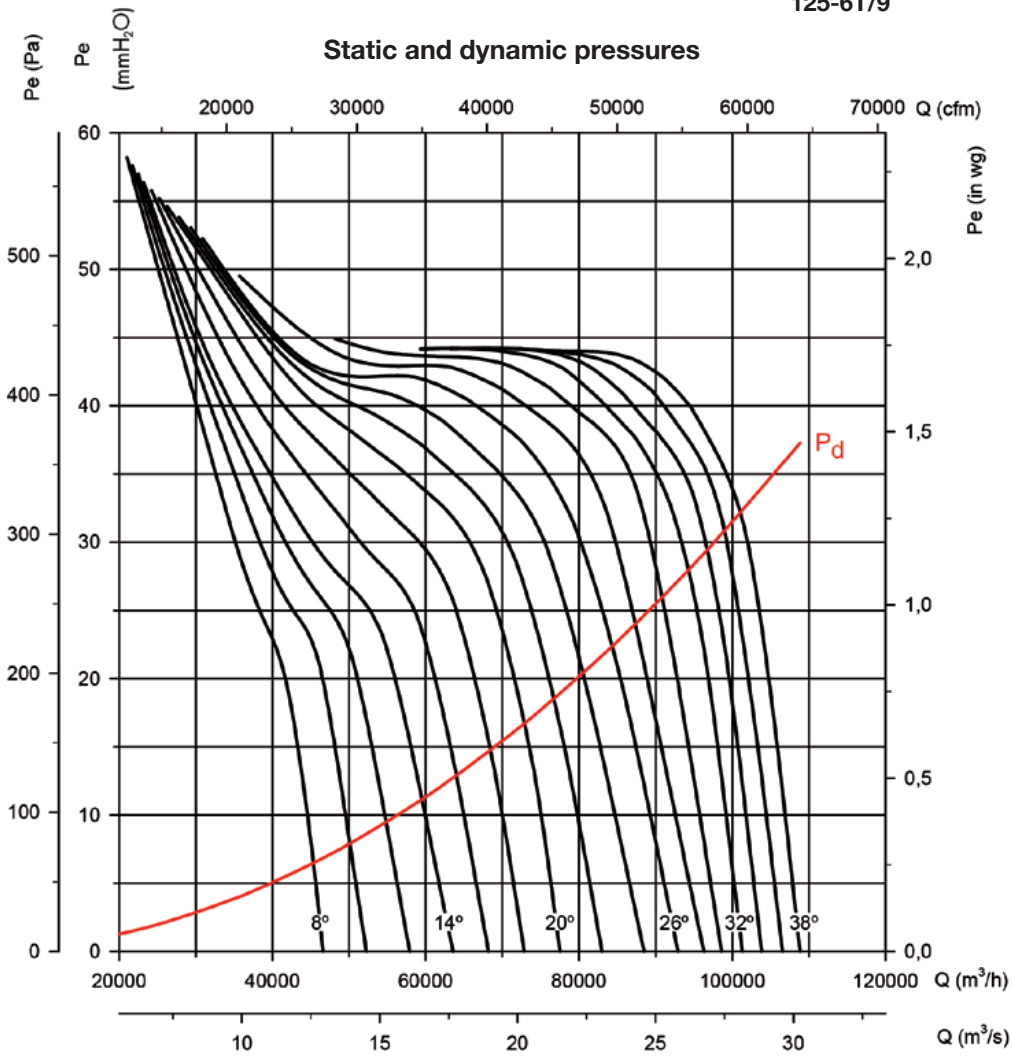

Absorbed power

Recommended
Motor Power
kW(HP)

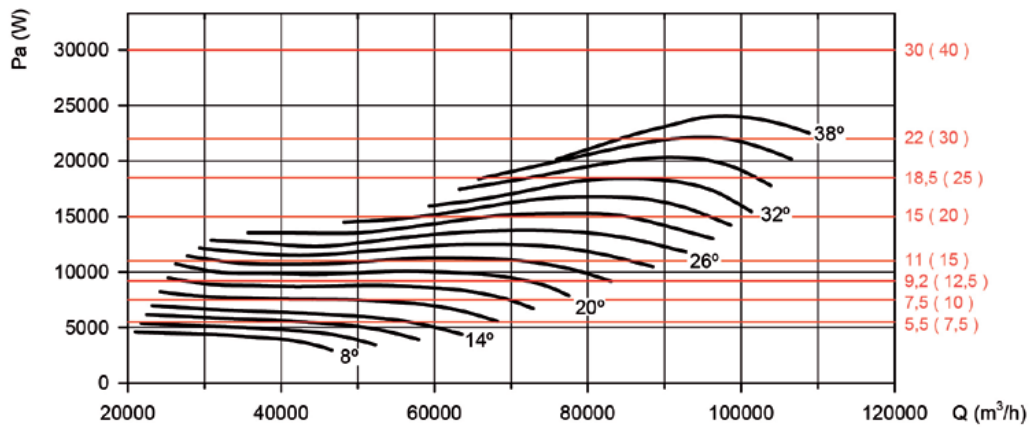

HTTI



Roof-mounted axial extract fans with inclined supports

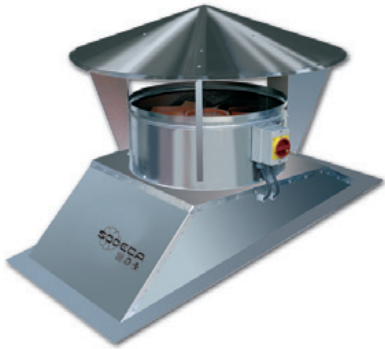

Roof-mounted axial extract fans adapted to the roof inclination, with built-in safety switch.

Fan:

- Galvanised sheet steel support base.
- Fibreglass-reinforced polyamide-6 impellers.
- Rain cap
- Airflow direction from motor to impeller.

Motor:

- IE3 efficiency motors for powers equal to or higher than 0.75kW except single-phase, 2-speed and 8-pole.
- Class F motors with ball bearings and IP55 protection.

- Three-phase 230/400V-50Hz (up to 4kW) and 400/690V-50Hz (powers higher than 4kW).
- Maximum temperature of air to be carried: -25°C +60°C.

Finish:

- Anti-corrosive finish on galvanised sheet steel.

On request:

- All the required base inclinations and measurements (max. length 2m)
- Made of stainless sheet steel plate.
- Special windings for different voltages
- ATEX-certified Category 2.

Order code

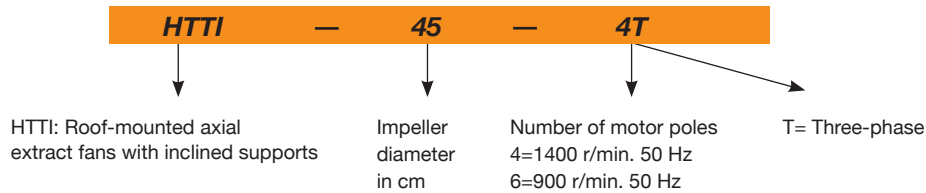

Technical characteristics

Model	Speed (r/min)	Maximum admissible current (A)			Installed power (kW)	Maximum flow rate (m³/h)	Sound pressure level dB(A)	Approx. weight (kg)	According to ErP
		230 V	400 V	690 V					
HTTI-50-4T	1380	2.92	1.69		0.55	9200	69	56	2015
HTTI-56-4T IE3	1455	4.07	2.34		1.10	11700	72	68	2015
HTTI-71-4T IE3	1440	5.41	3.11		1.50	18900	78	90	2015
HTTI-71-6T	900	2.99	1.73		0.55	13500	67	79	2015
HTTI-80-4T IE3	1440	10.70	6.15		3.00	33300	83	119	2015
HTTI-80-6T IE3	945	4.68	2.69		1.10	23400	72	109	2015
HTTI-90-4T IE3	1450	13.90	8.00		4.00	41850	89	139	2015
HTTI-90-6T IE3	950	6.43	3.70		1.50	30870	77	133	2015
HTTI-100-4T IE3	1465		13.90	8.06	7.50	56700	93	197	2015
HTTI-100-6T IE3	950	9.08	5.22		2.20	34200	82	154	2015



Erp. (Energy Related Products)

Information on Directive 2009/125/EC can be downloaded from the SODECA website or the QuickFan selector programme.

Accessories

See accessories section.



Dimensions mm

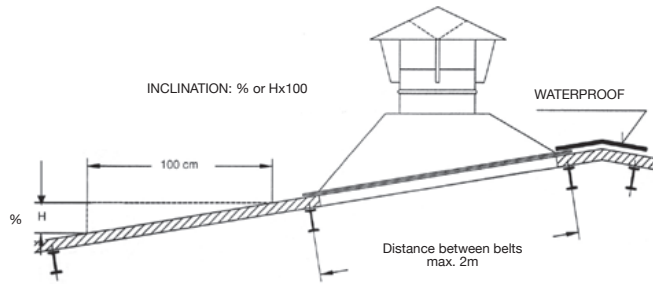

Model	A	B	C	D	ØF	G	H	ØI
HTTI-50-4T	800	150	200	250	950	780	570	520
HTTI-56-4T	800	150	200	250	1050	830	620	570
HTTI-71-4T	900	200	230	300	1250	990	780	730
HTTI-71-6T	900	200	230	300	1250	990	780	730
HTTI-80-4T	1100	250	310	330	1400	1080	870	820
HTTI-80-6T	1100	250	310	330	1400	1080	870	820
HTTI-90-4T	1150	300	310	330	1500	1080	970	920
HTTI-90-6T	1150	300	310	330	1500	1080	970	920
HTTI-100-4T	1200	350	310	330	1600	1280	1070	1020
HTTI-100-6T	1200	350	310	330	1600	1280	1070	1020

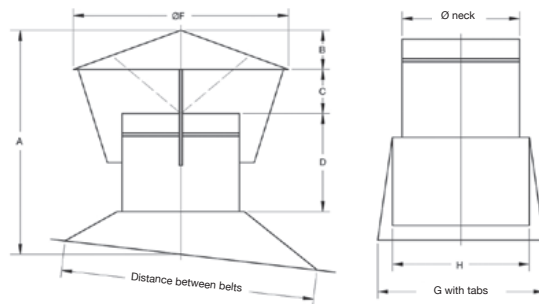

Characteristic curves

Q= Flow rate in m³/h, m³/s and cfm.

Pe= Static pressure in mm H₂O, Pa and inwg.

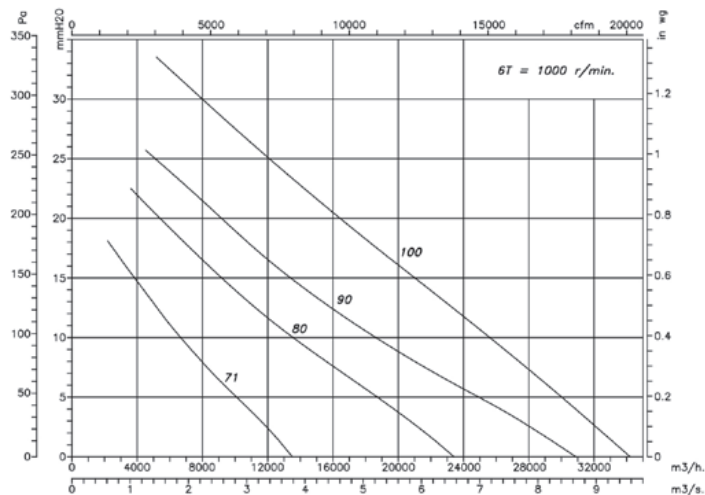
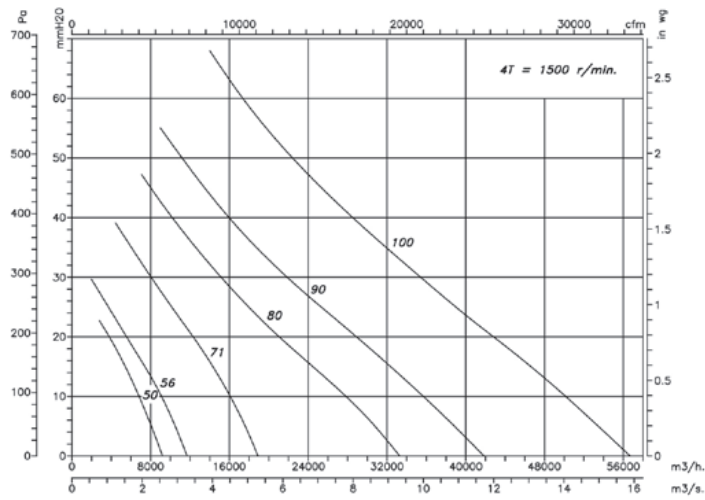

THT/HATCH



400°C/2h and 300°C/2h-rated dynamic discharge systems with motorised opening function, fitted with roof-mounted extract fan, for smoke extraction in the event of fire



Dynamic exhaust systems with roof-mounted extract fans and motorised opening function. Specially designed for the fast, effective extraction of harmful smoke and gases in the event of fire. Suitable for installation in industrial or commercial buildings. Approved in accordance with standard EN 12101-3, with F-400 and F-300 certificate.

The rapid smoke extraction permits the efficient intervention of fire fighters, fast evacuation of people and prevents new sources of fire and greater structural damage to the building. Can also be used for environmental ventilation in the buildings in which they are installed.



Fan:

- An extremely robust structure that is able to withstand severe weather changes.
- Equipment structure made of corrosion-proof galvanised sheet steel.
- Water-tight design to prevent the entry of water.
- Heat insulation of 60 mm to prevent hot air loss in the winter.
- Adaptable skirting for correct, easy installation on the roof.
- Maintenance switch fitted with NA/NC auxiliary contact to control equipment disconnection.
- Roof-mounted extract fans with F-400 No. 0370-CPR-1827 and F-300 No. 0370-CPR-0973 certification.
- Tubular casing in sheet steel with polyester resin anti-corrosive treatment.
- Cast aluminium orientable impellers.

Opening system:

- Motorised opening arms, with encapsulated IP-65 mechanism.
- 230V AC 50Hz power supply.
- Reinforced, guaranteed system with more than 10,000 operations at maximum load.
- Maximum load 1000 Nw.
- Automatic opening via external control system signal (fire station, smoke detector...). Control systems not included in the supply.
- Limit switch to signal the hatch position.

Motor:

- Class H motors, S1 continuous operation and S2 emergency use, with ball bearings and IP55 protection.
- IE3 efficiency motors for powers equal to or higher than 0.75kW except single-phase, 2-speed and 8-pole.
- Three-phase 230/400V-50Hz (up to 3kW) and 400/690V-50Hz (powers higher than 3kW).
- Maximum temperature of air to be carried: S1 -25°C +40°C continuous service, also suitable for warm climates with temperatures up to 50°C. S2 operation, 300°C/2h, 400°C/2h.

Finish:

- Anti-corrosive finish on galvanised sheet steel.

On request:

- Polyester resin corrosion-proof paint finish.
- Motorised opening arms with supply voltage of 24V. DC

Order code

THT/HATCH	—	40	—	2T	—	1	—	N	—	1	—	G		
THT/HATCH: 400°C/2h and 300°C/2h rated dynamic exhaust system with motorised opening function, fitted with roof-mounted extract fan, for smoke extraction in the event of fire.		Size		Number of motor poles 2=2900 r/min. 50 Hz 4=1400 r/min. 50 Hz 6=900 r/min. 50 Hz		T= Three-phase		Motor power (HP)		Electric accessories N= no accessories Y= Limit switch		Opening system supply voltage 1=230 V.AC 2=24 V.DC		Finish G=galvanised P=painted in special colour



Erp. (Energy Related Products)

Information on Directive 2009/125/EC can be downloaded from the SODECA website or the QuickFan selector programme.

Technical characteristics

Model	Speed (r/min)	Maximum admissible current (A)			Installed power (kW)	Maximum flow rate (m ³ /h)	Sound pressure level dB(A)	Approx. weight (kg)	According to ErP
		230 V	400 V	690 V					
THT/HATCH-40-2T-1 IE3	2850	3.15	1.80		0.75	6115	72	184	2015
THT/HATCH-40-2T-1.5 IE3	2880	4.70	2.70		1.10	7050	73	188	2015
THT/HATCH-45-2T-2 IE3	2880	5.90	3.40		1.50	9405	75	193	2015
THT/HATCH-45-2T-3 IE3	2840	8.70	5.00		2.20	11325	77	194	2015
THT/HATCH-50-2T-4 IE3	2880	11.20	6.50		3.00	13860	79	206	2015
THT/HATCH-56-2T-5.5 IE3	2870		9.50	5.50	4.00	18840	85	226	2015
THT/HATCH-56-2T-7.5 IE3	2910		10.60	6.14	5.50	22510	86	237	2015
THT/HATCH-63-4T-3 IE3	1425	9.00	5.20		2.20	22460	73	262	2015
THT/HATCH-63-4T-4 IE3	1430	11.40	6.60		3.00	24460	74	271	2015
THT/HATCH-63-6T-1 IE3	940	4.70	2.70		0.75	16025	63	252	2015
THT/HATCH-80-4T-3 IE3	1425	9.00	5.20		2.20	25545	79	280	2015
THT/HATCH-80-4T-4 IE3	1430	11.40	6.60		3.00	30410	80	289	2015
THT/HATCH-80-4T-5.5 IE3	1440		8.40	4.80	4.00	32940	81	295	2015
THT/HATCH-80-4T-7.5 IE3	1460		12.60	7.30	5.50	39820	82	311	2015
THT/HATCH-80-6T-1.5 IE3	945	5.50	3.20		1.10	21580	69	279	2015
THT/HATCH-80-6T-2 IE3	945	7.40	4.30		1.50	26090	70	288	2015
THT/HATCH-90-4T-7.5 IE3	1460		12.60	7.30	5.50	46325	88	392	2015
THT/HATCH-90-4T-10 IE3	1460		17.70	10.20	7.50	50315	89	403	2015
THT/HATCH-90-4T-15 IE3	1460		22.00	12.70	11.00	59610	90	456	2015
THT/HATCH-90-6T-3 IE3	950	9.50	5.50		2.20	34055	75	365	2015
THT/HATCH-90-6T-4 IE3	970	13.50	7.80		3.00	39055	76	391	2015
THT/HATCH-100-4T-10 IE3	1460		17.70	10.20	7.50	57650	90	413	2015
THT/HATCH-100-4T-15 IE3	1460		22.00	12.70	11.00	66505	91	466	2015
THT/HATCH-100-4T-20 IE3	1460		29.00	16.70	15.00	76445	92	481	2015
THT/HATCH-100-6T-5.5 IE3	970		11.00	6.40	4.00	47955	81	413	2015
THT/HATCH-100-6T-7.5 IE3	970		12.40	7.20	5.50	53545	82	420	2015
THT/HATCH-125-4T/6-25 IE3	1465		37.00	21.36	18.50	92550	87	746	2015
THT/HATCH-125-4T/6-30 IE3	1470		42.00	24.25	22.00	98850	87	760	2015
THT/HATCH-125-4T/6-40 IE3	1475		58.00	33.49	30.00	117450	89	841	2015
THT/HATCH-125-4T/6-50 IE3	1480		73.00	42.15	37.00	131050	90	889	2015
THT/HATCH-125-4T/9-25 IE3	1465		37.00	21.36	18.50	79650	85	755	2015
THT/HATCH-125-4T/9-30 IE3	1470		42.00	24.25	22.00	88300	86	769	2015
THT/HATCH-125-4T/9-40 IE3	1475		58.00	33.49	30.00	104050	88	850	2015
THT/HATCH-125-4T/9-50 IE3	1480		73.00	42.15	37.00	118400	90	898	2015
THT/HATCH-125-6T/6-5.5 IE3	970		11.00	6.35	4.00	51500	75	611	2015
THT/HATCH-125-6T/6-7.5 IE3	970		14.00	8.08	5.50	60650	75	618	2015
THT/HATCH-125-6T/6-10 IE3	960		18.60	10.74	7.50	72650	77	643	2015
THT/HATCH-125-6T/6-15 IE3	955		26.00	15.01	11.00	85850	79	673	2015
THT/HATCH-125-6T/6-20 IE3	950		35.50	20.50	15.00	92850	80	746	2015
THT/HATCH-125-6T/9-10 IE3	960		18.60	10.74	7.50	63500	76	652	2015
THT/HATCH-125-6T/9-15 IE3	955		26.00	15.01	11.00	77550	79	682	2015
THT/HATCH-125-6T/9-20 IE3	950		35.50	20.50	15.00	92950	82	755	2015

Technical characteristics of the dynamic exhaust system based on standards EN-12101-3 and EN-12101-2.

Model	Approval °C	Motor insulation class	Durability	Temperature room temperature	Wind load (Pa)	Snow load (Pa)
THT/HATCH	F-400	Class H	RE 10000	T (-25)	WL 200	SL 800
THT/HATCH 125	F-400	Class H	RE 1000	T (0)	WL 200	SL 1000

Acoustic characteristics

The indicated values are determined by measuring the sound pressure level and sound power in dB(A) obtained in a free field at a distance equivalent to twice the size of the fan plus the impeller diameter, with a minimum of 1.5 m.

Sound power spectrum Lw(A) in dB(A) per Hz frequency band.

Model	63	125	250	500	1000	2000	4000	8000	Model	63	125	250	500	1000	2000	4000	8000
40-2-1	44	65	72	77	80	76	69	58	100-4-10	60	80	88	93	95	92	85	74
40-2-1.5	45	66	73	78	81	77	70	59	100-4-15	59	79	87	92	94	91	84	73
45-2-2	47	68	75	80	83	79	72	61	100-4-20	61	81	89	94	96	93	86	75
45-2-3	49	70	77	82	85	81	74	63	100-6-5.5	62	71	79	84	86	83	76	65
50-2-4	54	74	82	87	89	86	79	68	100-6-7.5	63	72	80	85	87	84	77	66
56-2-5.5	60	80	88	93	95	92	85	74	125-4T/6-25	65	73	89	96	98	93	87	83
56-2-7.5	61	81	89	94	96	93	86	75	125-4T/6-30	65	73	89	96	98	93	87	83
63-4-3	50	68	76	81	83	80	75	64	125-4T/6-40	67	75	91	98	100	95	89	85
63-4-4	51	69	77	82	84	81	76	65	125-4T/6-50	68	76	92	99	101	96	90	86
63-6-1	41	60	68	73	75	72	65	55	125-4T/9-25	63	71	88	94	95	90	85	81
80-4-3	56	75	83	89	90	87	81	70	125-4T/9-30	64	72	89	95	96	91	86	82
80-4-4	54	74	82	87	89	86	79	71	125-4T/9-40	66	74	91	97	98	93	88	84
80-4-5.5	54	74	82	87	89	86	79	72	125-4T/9-50	68	76	93	99	100	95	90	86
80-4-7.5	55	75	83	88	90	87	80	73	125-6T/6-5.5	58	67	80	83	84	81	70	66
80-6T-1.5	47	64	72	77	79	76	69	58	125-6T/6-7.5	58	67	80	83	84	81	70	66
80-6-2	48	65	73	78	80	77	70	59	125-6T/6-10	60	69	82	85	86	83	72	68
90-4-7.5	57	78	85	90	93	89	82	71	125-6T/6-15	62	71	84	87	88	85	74	70
90-4-10	56	77	84	89	92	88	81	70	125-6T/6-20	63	72	85	88	89	86	75	71
90-4-15	58	79	86	91	94	90	83	72	125-6T/9-10	56	66	81	85	84	83	72	68
90-6-3	54	68	75	80	83	79	72	61	125-6T/9-15	59	69	84	88	87	86	75	71
90-6-4	55	70	77	82	85	81	74	63	125-6T/9-20	62	72	87	91	90	89	78	74

Dimensions mm

THT/HATCH-40...100

Model	A	B	C	D	ød1	E	F	H	H1	J	K
THT/HATCH-40	1100	990	1022	920	400	1100	1000	940	1000	900	800
THT/HATCH-45	1100	990	1022	920	450	1100	1000	940	1000	900	800
THT/HATCH-50	1100	990	1022	920	500	1100	1000	940	1000	900	800
THT/HATCH-56	1100	990	1022	920	560	1100	1000	940	1000	900	800
THT/HATCH-63	1295	1195	1222	1122	630	1300	1200	940	1000	1100	1000
THT/HATCH-80	1295	1195	1222	1122	800	1300	1200	940	1000	1100	1000
THT/HATCH-90	1492	1392	1420	1320	900	1500	1400	940	1000	1300	1200
THT/HATCH-100	1492	1392	1420	1320	1000	1500	1400	940	1000	1300	1200

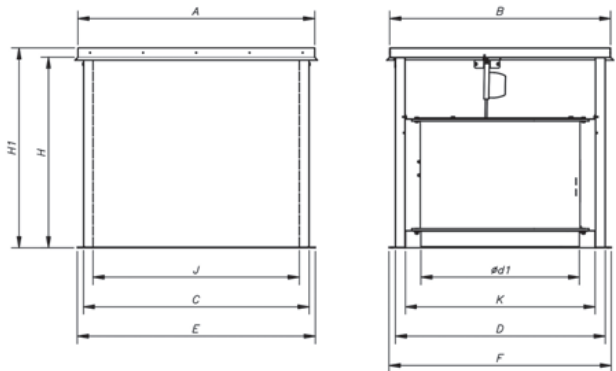

THT/HATCH-125

Model	A	B	C	D	ød1	E	F	H	H1	J	K
THT/HATCH-125	1750	1775	1700	1700	1245	1780	1780	1230	1290	1580	1580

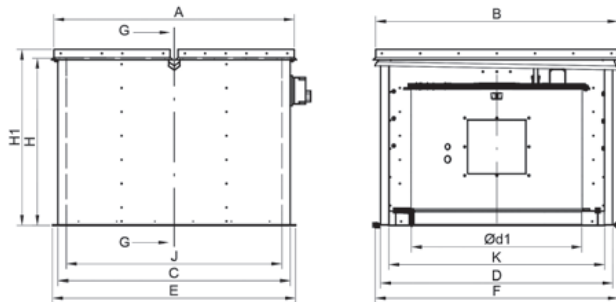

Installation diagram

1. THT/HATCH box
2. THT fan
3. Motorised arms (230V AC or 24V DC x2)
4. Protective grille impulsion
5. Connection flange in inlet conduit
6. Inlet protective grille (optional)
7. Roof opening
8. Roof
9. Protection against water entry.
10. Direct assembly using the adjustable baseboard.

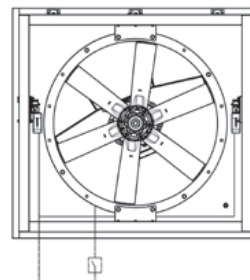
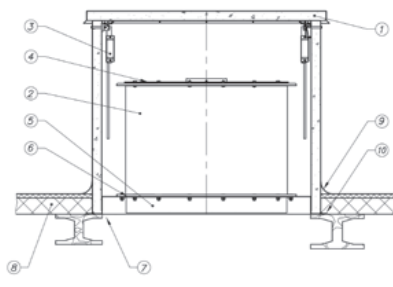

— Pre-installed by the manufacturer
 - - - - - To be performed by the installer.

Note: For motors with powers greater than 5.5kW it is advisable to use an electronic starter

Actuator power supply 1x230V 50Hz
 Motor power supply 3x400V 50Hz or 24 VDC

Characteristic curves

Q= Flow rate in m³/h, m³/s and cfm.

Pe= Static pressure in mmH₂O, Pa and inwg.

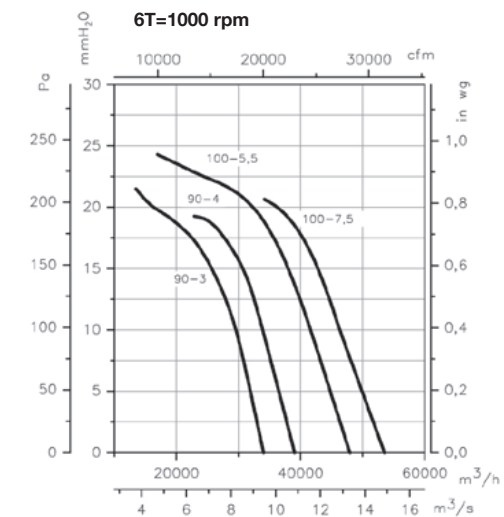
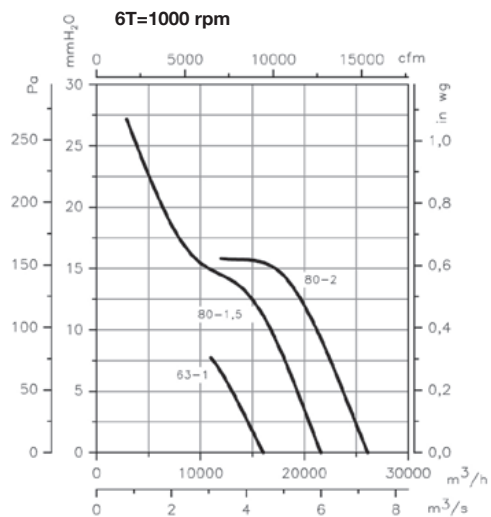
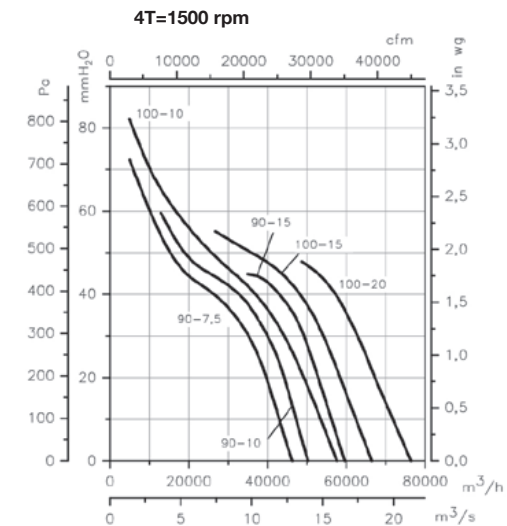
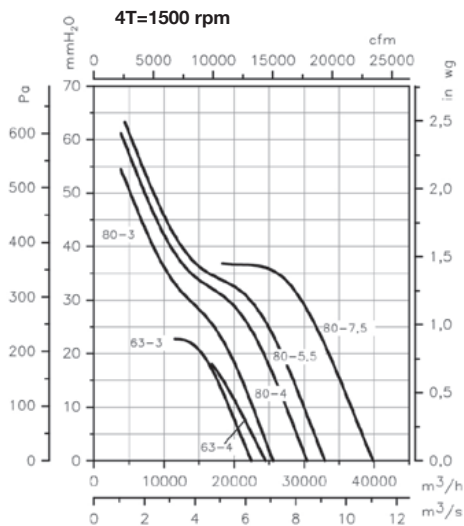
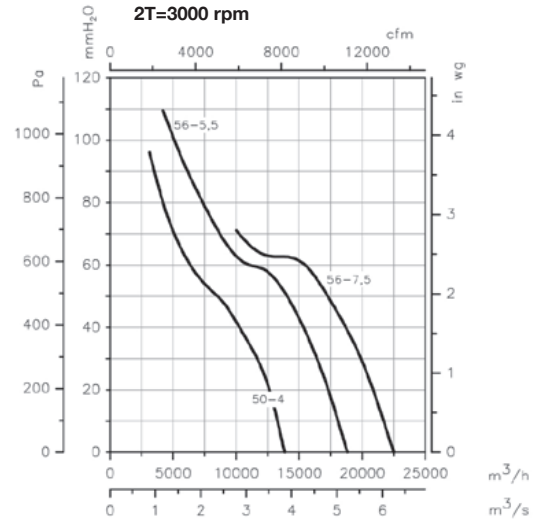
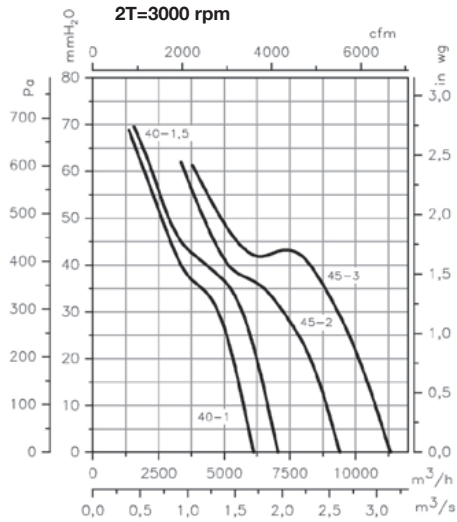

Characteristic curves

Q= Flow rate in m³/h, m³/s and cfm.

Pe= Static pressure in mmH₂O, Pa and inwg.

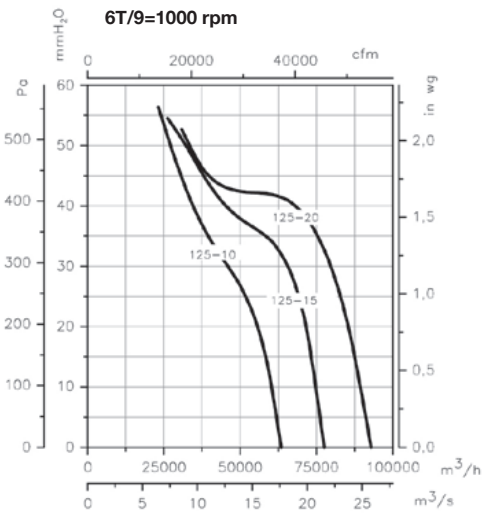
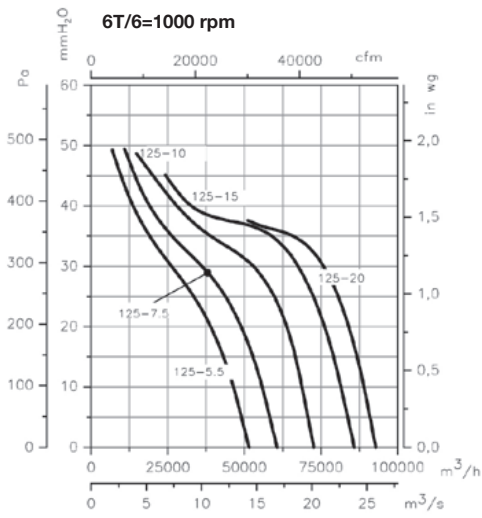
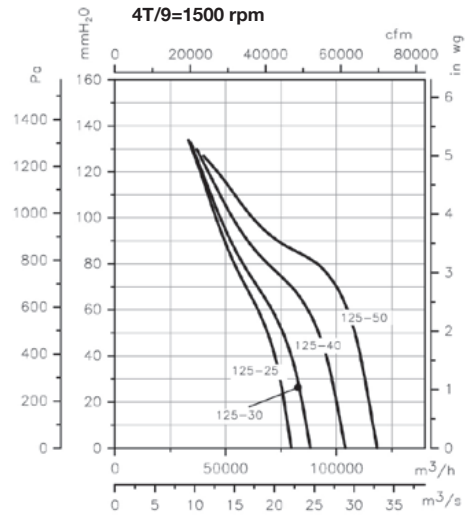
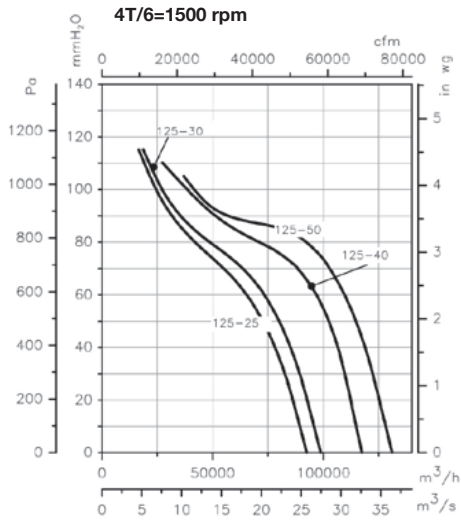

CRF

Centrifugal roof-mounted extract fans, with low noise level



Centrifugal roof-mounted extract fans with low noise level and external rotor motor.

Fan:

- Made of galvanised sheet steel.
- Impeller with reaction blades built of aluminium sheet metal except for models 225 and 250, which are made of galvanised sheet steel.
- Bird guard.
- Folding body for ease of inspection and maintenance.

Motor:

- Class F motors, external rotor and IP54 protection.

- Single-phase 230V-50/60Hz, except 450 and 500 230V-50Hz models.
- Three-phase 400V-50/60Hz, except 450 and 500 400V-50Hz models.
- Maximum temperature of air to be carried: -25°C +50°C.

Finish:

- Anti-corrosive finish on galvanised sheet steel.

On request:

- The variable speed drive (VSD) is supplied on request.

Order code

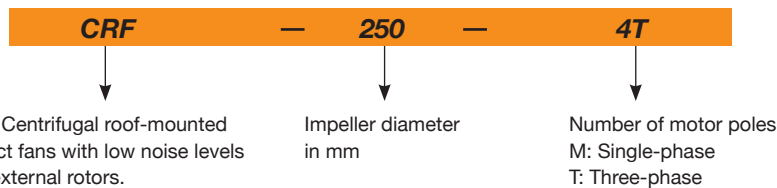

Technical characteristics

Model	Speed (r/min)	Maximum admissible current (A)		Maximum electric power (kW)	Maximum flow rate (m ³ /h)	Sound pressure level dB(A) ⁽¹⁾		Weight (kg)	Recommended VSD	According to ErP
		230V	400V			Inlet	Exhaust			
CRF-225-4M	1420	0.20		0.04	650	31	37	11	VSD1/M-0.5	2018
CRF-250-4M	1440	0.31		0.06	950	32	38	12	VSD1/M-0.5	2018
CRF-250-4T	1450		0.28	0.06	950	32	38	12	VSD3/A-RFT-1	2018
CRF-315-4M	1400	0.60		0.14	2000	39	45	17	VSD1/M-0.5	2018
CRF-315-4T	1430		0.35	0.14	2000	39	45	17	VSD3/A-RFT-1	2018
CRF-315-6M	940	0.38		0.08	1280	28	34	17	VSD1/M-0.5	2016
CRF-315-6T	900		0.20	0.07	1280	28	34	17	VSD3/A-RFT-1	2016
CRF-355-4M	1400	0.75		0.17	2500	43	48	24	VSD1/M-0.5	2018
CRF-355-4T	1400		0.45	0.18	2500	43	48	24	VSD3/A-RFT-1	2018
CRF-355-6M	930	0.46		0.10	1800	31	38	24	VSD1/M-0.5	2018
CRF-355-6T	950		0.32	0.10	1800	31	38	24	VSD3/A-RFT-1	2018
CRF-400-4M	1350	1.20		0.26	2810	46	52	28	VSD1/M-0.5	2018
CRF-400-4T	1380		0.60	0.27	2810	46	52	28	VSD3/A-RFT-1	2018
CRF-400-6M	940	0.72		0.14	2400	35	41	28	VSD1/M-0.5	2018
CRF-400-6T	900		0.40	0.15	2400	35	41	28	VSD3/A-RFT-1	2018
CRF-450-4M	1400	3.20		0.55	5400	53	59	42	VSD1/M-0.5	2018
CRF-450-4T	1340		1.00	0.55	5400	53	59	42	VSD3/A-RFT-1	2018
CRF-450-6M	930	1.30		0.26	3700	42	48	42	VSD1/M-0.5	2018
CRF-450-6T	920		1.00	0.30	3700	42	48	42	VSD3/A-RFT-1	2018
CRF-500-4T	1400		2.50	1.10	7600	57	62	51	VSD3/A-RFT-2	2018
CRF-500-6M	920	1.80		0.40	5200	45	52	51	VSD1/M-0.5	2018
CRF-500-6T	950		1.25	0.45	5200	45	52	51	VSD3/A-RFT-1	2018

(1) The noise level values are pressures in dB(A) measured at a distance of 6 metres and at 2/3 of the maximum flow rate (2/3 Qmax).



Erp. (Energy Related Products)

Information on Directive 2009/125/EC can be downloaded from the SODECA website or the QuickFan selector programme.

Acoustic characteristics

Sound power spectrum Lw(A) in dB(A) per Hz frequency band.

Values measured at inlet with 2/3 maximum flow rate (2/3Qmax).

Model	63	125	250	500	1000	2000	4000	8000
225	29	35	46	49	50	46	44	38
250	30	36	47	50	51	47	45	39
315-4	40	49	54	54	58	57	50	44
315-6	29	38	43	43	47	46	39	33
355-4	44	53	58	58	62	61	54	48
355-6	32	41	46	46	50	49	42	36
400-4	48	54	60	60	63	66	57	51
400-6	37	43	49	49	52	55	46	40
450-4	55	61	67	67	70	73	64	58
450-6	44	50	56	56	59	62	53	47
500-4	60	67	72	72	76	75	68	63
500-6	48	55	60	60	64	63	56	51

Values measured at exhaust with 2/3 maximum flow rate (2/3Qmax).

Model	63	125	250	500	1000	2000	4000	8000
225	33	38	52	54	55	55	50	45
250	34	39	53	55	56	56	51	46
315-4	39	48	58	62	65	62	55	49
315-6	28	37	47	51	54	51	44	38
355-4	42	51	61	65	68	65	58	52
355-6	32	41	51	55	58	55	48	42
400-4	47	59	67	69	70	70	62	54
400-6	36	48	56	58	59	59	51	43
450-4	54	66	74	76	77	77	69	61
450-6	43	55	63	65	66	66	58	50
500-4	58	70	78	80	81	78	71	63
500-6	48	60	68	70	71	68	61	53

To obtain the Lwa noise power spectra in dB(A) in inlet at maximum flow rate (Qmax), add the values set out in the following chart to the LpA sound pressure level given in the characteristic curves:

Frequency band (Hz)								
63	125	250	500	1000	2000	4000	8000	
2	9	15	15	18	18	11	5	

Dimensions mm

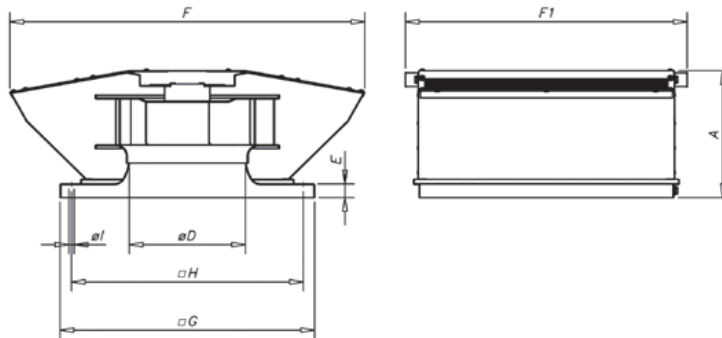

Model	A	ØD*	E	F	F1	G	H	øl
CRF-225	185	146	30	477	420	355	305	12
CRF-250	189	165	30	518	465	400	350	12
CRF-315	265	205	30	690	514	450	400	12
CRF-355	280	230	30	781	622	560	510	12
CRF-400	280	260	30	781	622	560	510	12
CRF-450	400	290	30	1110	775	710	660	12
CRF-500	400	325	30	1110	775	710	660	12

(*) Recommended pipe nominal diameter

Accessories



Characteristic curves

Q= Flow rate in m³/h, m³/s and cfm.

Pe= Static pressure in mm H₂O, Pa and inwg.

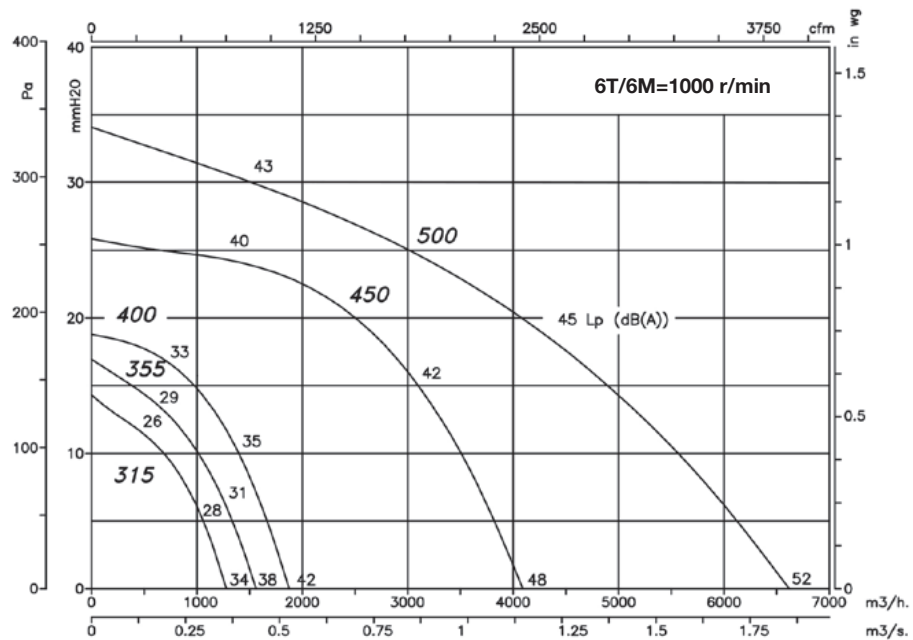
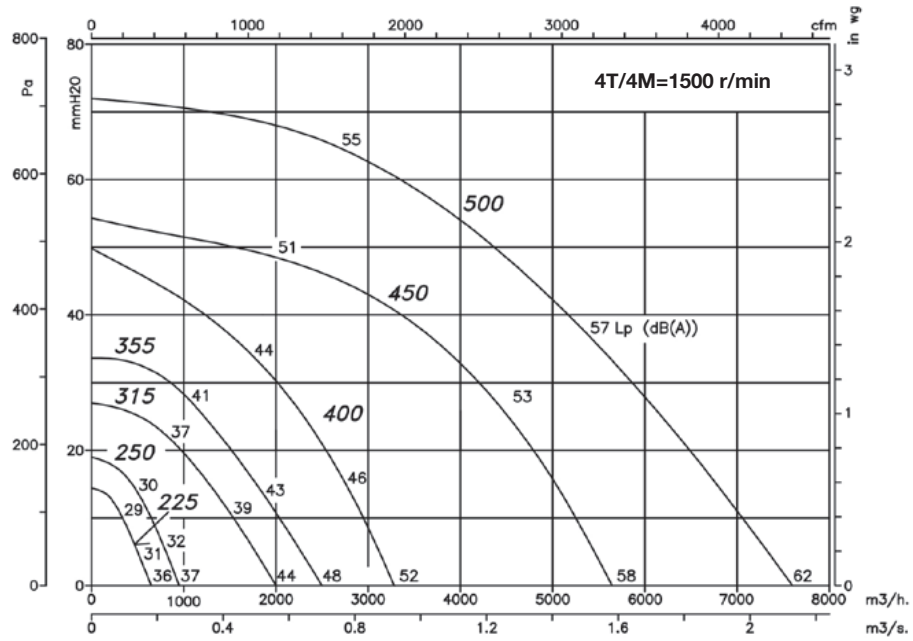

CRF/EW/CPC



Centrifugal, roof-mounted, automatic operation extract fans with low noise levels, fitted with E.C. Technology external rotor motor and constant pressure control



Centrifugal roof-mounted extract fans with low noise levels and external rotor motor, fitted with an E.C. Technology motor.

Fan:

- Made of galvanised sheet steel.
- Impeller with reaction blades made of plastic material.
- Bird guard.
- Folding body for ease of inspection and maintenance.

Motor:

- High efficiency EC external rotor motors regulated by 0-10V signal. IP54 protection.
- Single-phase 230V-50/60Hz and three-phase 400V-50/60Hz.
- Maximum temperature of air to be carried: -25°C + 50°C.

CPC control:

- Equipment preconfigured in constant pressure mode with 100 Pa setpoint.

- Possibility of adjustment to other pressures.
- Possibility of working with a constant flow rate. Except models 190 and 250.
- Plug&Play system for easy installation.
- Programming range from 0 to 2500 Pa.
- On-off switch with built-in safety locking system.
- 230 V AC single-phase and 380 V AC three-phase power versions.
- IP55 protection.

Finish:

- Anti-corrosive finish on galvanised sheet steel.

Order code

CRF/EW — 315 — M / L / CPC

CRF/EW: Centrifugal roof-mounted extract fans with low noise levels and EC external rotor motor.

Impeller diameter in mm

M: Single-phase
T: Three-phase

L: Low flow rate
M: Medium flow rate
H: High flow rate

Automatic constant pressure regulation control.

Technical characteristics

Model	Maximum speed (r/min)	Maximum admissible current (A)		Max. electric power (kW)	Maximum flow rate (m³/h)	SPL at maximum speed dB(A)		Approx. weight (kg)	According to ErP
		230V	400V			Inlet	Exhaust		
CRF/EW-190-M/CPC	3200	0.75		0.083	695	42	45	10	2018
CRF/EW-250-M/CPC	2510	1.4		0.17	1305	44	47	12	2018
CRF/EW-315-M/L/CPC	1524	1.2		0.15	2170	35	38	16	2018
CRF/EW-315-M/H/CPC	2360	2.2		0.5	3365	49	52	18	2018
CRF/EW-400-M/L/CPC	1170	1.1		0.25	4020	39	42	26	2018
CRF/EW-400-M/M/CPC	1500	2.2		0.5	5285	45	48	27	2018
CRF/EW-400-M/H/CPC	1700	3.3		0.75	5830	49	52	28	2018
CRF/EW-400-T/CPC	2060		2.1	1.32	6330	51	58	29	2018
CRF/EW-500-M/CPC	1100	3.3		0.75	7950	43	49	48	2018
CRF/EW-500-T/L/CPC	1350		2.1	1.32	9560	48	54	50	2018
CRF/EW-500-T/H/CPC	1700		4	2.65	10625	53	60	59	2018

* The noise level values are pressures in dB(A) measured at a distance of 6 metres and at 2/3 of the maximum flow rate (2/3 Qmax).

Acoustic characteristics

Sound power spectrum Lw(A) in dB(A) per Hz frequency band.

Values measured at inlet with 2/3 maximum flow rate (2/3Qmax).

Model	63	125	250	500	1000	2000	4000	8000
190-M	28	45	51	58	60	61	57	52
250-M	34	49	55	60	62	61	59	50
315-M/L	29	51	48	53	53	51	47	40
315-M/H	46	61	63	66	65	66	61	55
400-M/L	35	55	52	57	55	53	51	53
400-M/M	46	60	57	63	61	59	54	57
400-M/H	39	63	62	68	65	63	58	60
400-T	40	53	65	71	68	68	63	63
500-M	41	55	56	60	62	61	57	50
500-T/L	45	57	60	65	65	65	62	56
500-T/H	50	63	66	70	71	71	68	62

Values measured at exhaust with 2/3 maximum flow rate (2/3Qmax).

Model	63	125	250	500	1000	2000	4000	8000
190-M	31	48	54	61	63	64	60	55
250-M	37	52	58	63	65	64	62	53
315-M/L	32	54	51	56	56	54	50	43
315-M/H	49	64	66	69	68	69	64	58
400-M/L	38	58	55	60	58	56	54	56
400-M/M	49	63	60	66	64	62	57	60
400-M/H	42	66	65	71	68	66	61	63
400-T	45	56	68	73	78	76	70	66
500-M	43	56	59	67	69	65	59	53
500-T/L	46	59	63	71	75	69	65	59
500-T/H	52	65	69	77	81	75	71	65

Dimensions mm

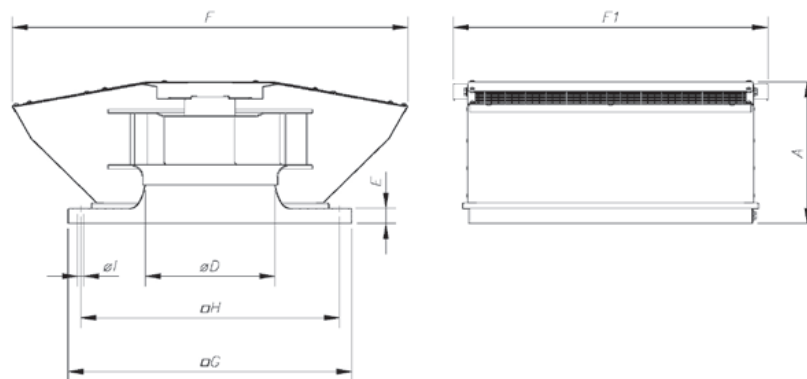

Model	A	ØD*	E	F	F1	G	H	ØI
CRF/EW/CPC-190	185	124	30	477	420	355	305	12
CRF/EW/CPC-250	190	165	30	518	465	400	350	12
CRF/EW/CPC-315	277	196	30	701	515	450	400	12
CRF/EW/CPC-400	347	257	30	850	601	560	510	12
CRF/EW/CPC-500	426	326	30	1137	752	710	660	12

* Recommended nominal tube diameter

Accessories

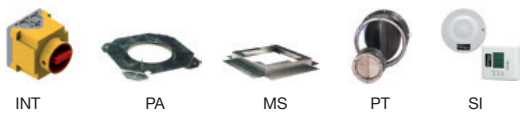

INT

PA

MS

PT

SI

Characteristic curves

Q= Flow rate in m³/h, m³/s and cfm.

Pe= Static pressure in mm H₂O, Pa and inwg.

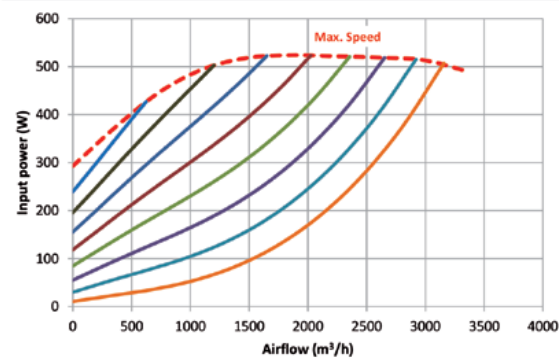
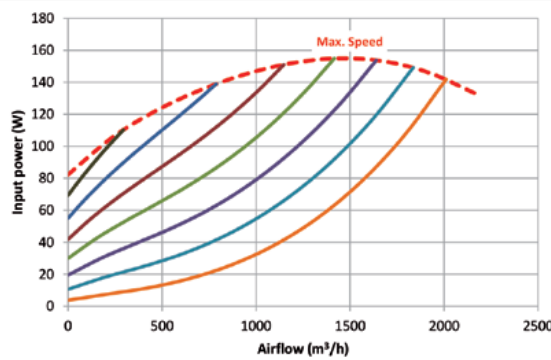
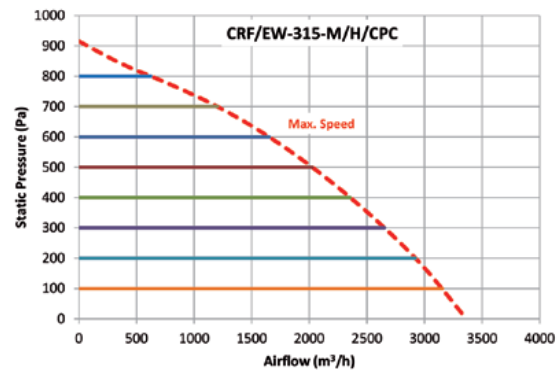
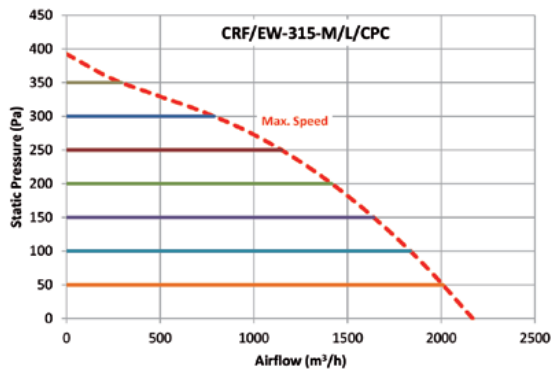
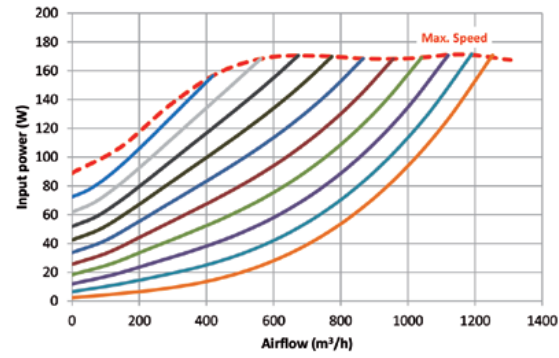
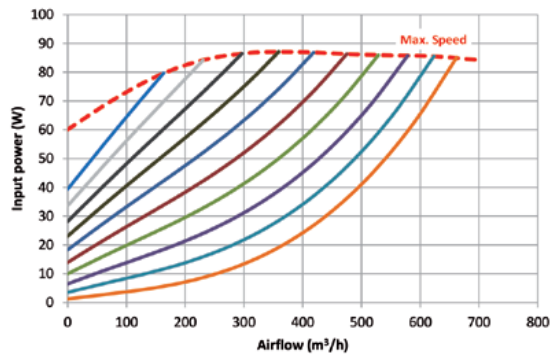
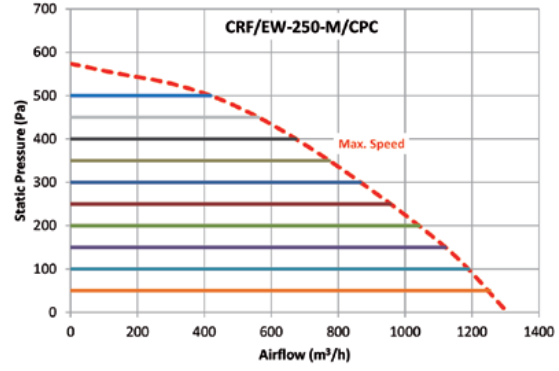
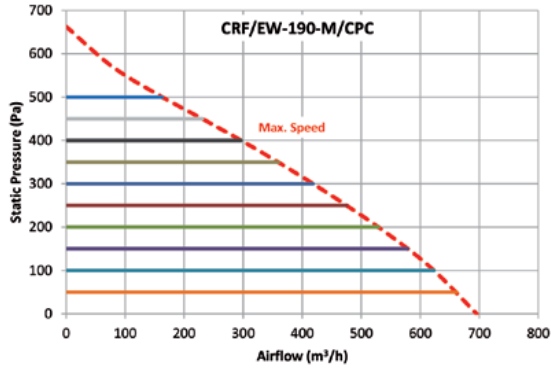

Characteristic curves

Q= Flow rate in m³/h, m³/s and cfm.

Pe= Static pressure in mm H₂O, Pa and inwg.

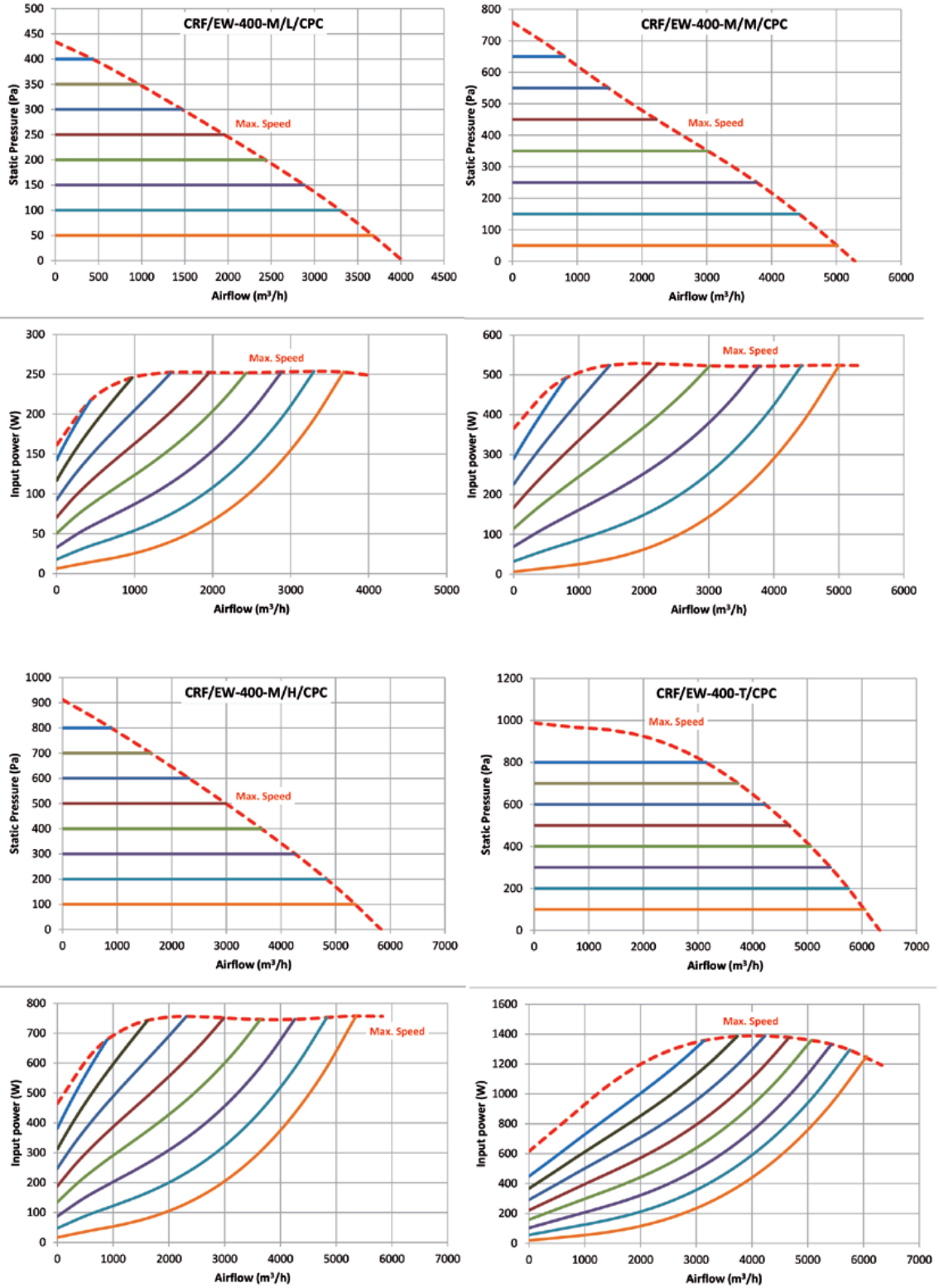

Characteristic curves

Q= Flow rate in m³/h, m³/s and cfm.

Pe= Static pressure in mm H₂O, Pa and inwg.

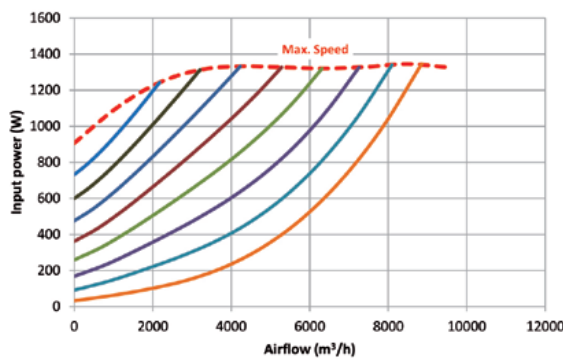
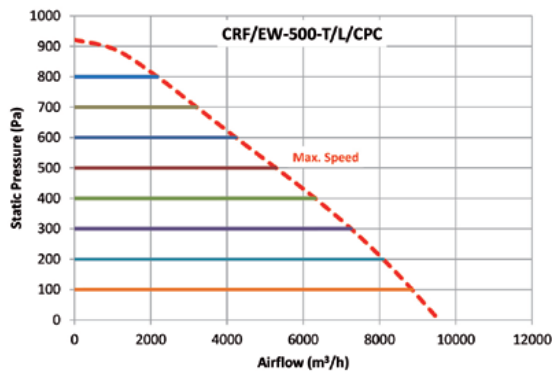
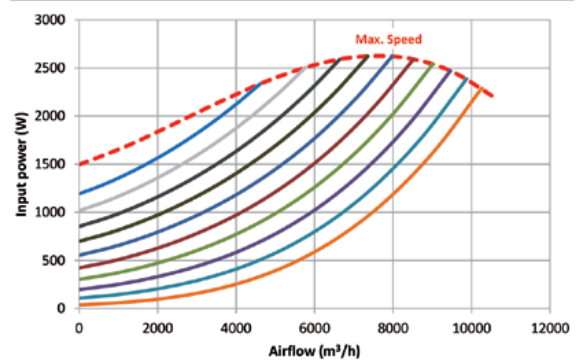
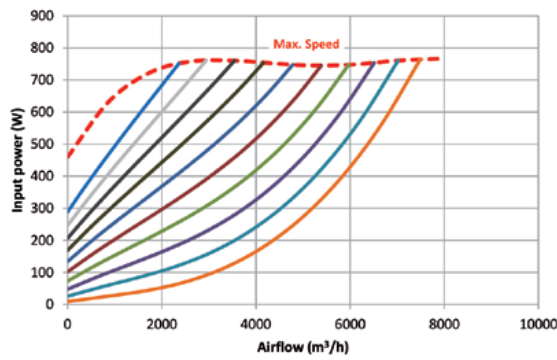
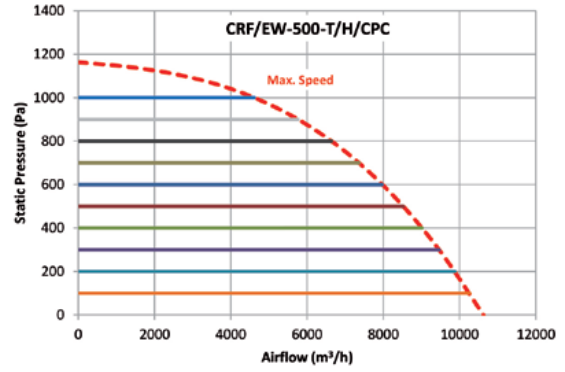
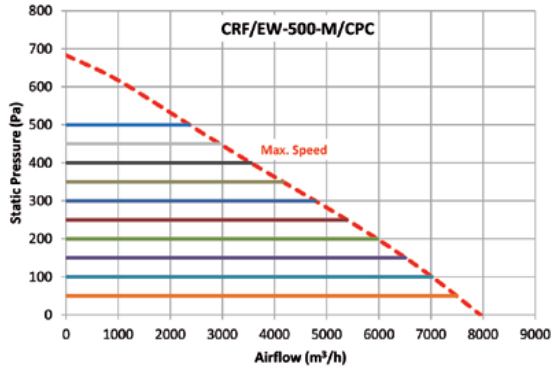

CHT CVT

400°C/2h centrifugal roof-mounted extract fans, with horizontal or vertical air outlets



CHT



CVT

CHT: 400°C/2h centrifugal roof-mounted extract fans, with horizontal air outlet and aluminium rain cover.

CVT: 400°C/2h centrifugal roof-mounted extract fans, with vertical air outlet and aluminium rain cover.

Fan:

- Galvanised sheet steel support base.
- Impeller with reaction blades, made of galvanised sheet steel.
- Bird guard.
- Aluminium rain cover.
- Approved in accordance with standard EN 12101-3, with certificate no.: 0370-CPR-0897.

Motor:

- IE3 efficiency motors for powers equal to or higher than 0.75kW except single-phase, 2-speed and 8-pole.

- Class F motors with ball bearings and IP55 protection except single-phase models, IP54 protection and 1 or 2 speeds, depending on model.
- Single-phase 230V-50Hz and three-phase 230/400V-50Hz.
- Maximum temperature of air to be carried: -25°C+ 120°C.

Finish:

- Anti-corrosive galvanised sheet steel and aluminium.

On request:

- Special windings for different voltages
- ATEX-certified Category 3.



Support for roof-mounting



Order code



CHT: 400°C/2h centrifugal roof-mounted extract fans, with horizontal air outlet.

CVT: 400°C/2h centrifugal roof-mounted extract fans, with vertical air outlet

Impeller size

Number of motor poles
2=2900 r/min. 50 Hz
4=1400 r/min. 50 Hz
6=900 r/min. 50 Hz

T= Three-phase

BS: Raised support base
BSS: Raised support base with silencer

Technical characteristics

Model	Speed (r/min)	Maximum admissible current (A)		Installed power (kW)	Maximum flow rate (m³/h)	Sound pressure level dB(A)		Approx. weight (kg)	According to ErP
		230 V	400 V			Inlet	Exhaust		
CHT CVT 200-4T	1350	1.66	0.96	0.25	1450	37	43	25	2018
CHT CVT 200-4M	1380	0.65		0.25	1450	37	43	25	2018
CHT CVT 225-4T	1350	1.66	0.96	0.25	2100	41	47	25	2018
CHT CVT 225-4M	1380	0.95		0.25	2100	41	47	25	2018
CHT CVT 250-4T	1350	1.66	0.96	0.25	3100	45	50	34	2018
CHT CVT 250-4M	1380	1.35		0.25	3100	45	50	34	2018
CHT CVT 315-4T	1380	2.92	1.69	0.55	4950	48	54	39	2018
CHT CVT 315-4M	1380	3.30		0.55	4950	48	54	39	2018
CHT CVT 315-6T	900	2.24	1.30	0.37	3200	37	43	39	2018
CHT CVT 315-6M	910	0.95		0.37	3200	37	43	39	2018
CHT CVT 400-4T IE3	1420	2.82	1.62	0.75	7000	55	61	58	2018
CHT CVT 400-4M	1380	4.40		0.75	7000	55	61	57	2018
CHT CVT 400-6T	900	2.24	1.30	0.37	4500	44	50	56	2018
CHT CVT 450-4T IE3	1440	5.41	3.11	1.50	10200	59	64	74	2018

Technical characteristics

Model	Speed (r/min)	Maximum admissible current (A)		Installed power (kW)	Maximum flow rate (m ³ /h)	Sound pressure level dB(A)		Approx. weight (kg)	According to ErP
		230 V	400 V			Inlet	Exhaust		
CHT CVT 450-6T	900	2.24	1.30	0.37	6900	47	54	59	2018
CHT CVT 500-6T IE3	945	4.68	2.69	1.10	12000	51	57	109	2018
CHT CVT 560-6T IE3	950	9.08	5.22	2.20	17300	54	61	130	2018
CHT CVT 630-6T IE3	960	15.60	8.99	4.00	24700	58	64	164	2018



Erp. (Energy Related Products)

Information on Directive 2009/125/EC can be downloaded from the SODECA website or the QuickFan selector programme.

Acoustic characteristics

The indicated values are determined by measuring the pressure and noise level in dB(A) obtained in a free field at a distance of 6 m.

Sound power spectrum Lw(A) in dB(A) per Hz frequency band

Values measured at inlet with 2/3 maximum flow rate (2/3Qmax).

Model	63	125	250	500	1000	2000	4000	8000
200	35	41	52	55	56	52	50	44
225-4	42	51	56	56	60	59	52	46
250-4	46	55	60	60	64	63	56	50
315-4	50	56	62	62	65	68	59	53
315-6	39	45	51	51	54	57	48	42
400-4	57	63	69	69	72	75	66	60
400-6	46	52	58	58	61	64	55	49
450-4	62	69	74	74	78	77	70	65
450-6	50	57	62	62	66	65	58	53
500-6	54	60	65	66	70	69	62	55
560-6	57	63	68	69	73	72	65	58
630-6	61	67	72	73	77	76	69	62

Values measured at exhaust with 2/3 maximum flow rate (2/3Qmax).

Model	63	125	250	500	1000	2000	4000	8000
200	39	44	58	60	61	61	56	51
225-4	41	50	60	64	67	64	57	51
250-4	44	53	63	67	70	67	60	54
315-4	49	61	69	71	72	72	64	56
315-6	38	50	58	60	61	61	53	45
400-4	56	68	76	78	79	79	71	63
400-6	45	57	65	67	68	68	60	52
450-4	60	72	80	82	83	80	73	65
450-6	50	62	70	72	73	70	63	55
500-6	50	64	72	76	75	72	66	60
560-6	54	68	76	80	79	76	70	64
630-6	57	71	79	83	72	79	73	67

To obtain the Lwa noise power spectra in dB(A) in inlet at maximum flow rate (Qmax), add the values set out in the following chart to the LpA sound pressure level given in the characteristic curves:

Frequency band (Hz)							
63	125	250	500	1000	2000	4000	8000
2	9	15	15	18	18	11	5

Dimensions mm

CHT

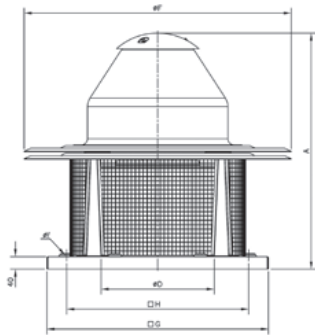

Model	A	øD*	øF	G	H	øl
CHT-200	552	250	570	450	360	12
CHT-225	570	250	570	450	360	12
CHT-250	632	355	726	560	450	12
CHT-315	682	355	726	560	450	12
CHT-400	755	500	856	710	590	12
CHT-450	770	500	856	710	590	12
CHT-500	846	630	1075	900	750	14
CHT-560	1035	710	1300	1100	900	14
CHT-630	1098	710	1300	1100	900	14

(*) Recommended pipe nominal diameter

CVT

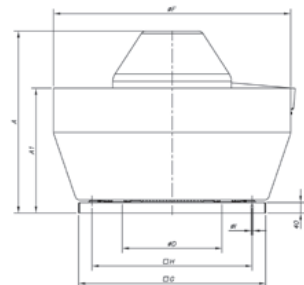

Model	A	A1	øD*	øF	G	H	øl
CVT-200	500	308	250	530	450	360	12
CVT-225	517	308	250	530	450	360	12
CVT-250	580	380	355	705	560	450	12
CVT-315	630	380	355	705	560	450	12
CVT-400	690	475	500	900	710	590	12
CVT-450	705	475	500	900	710	590	12
CVT-500	775	545	630	1100	900	750	14
CVT-560	956	676	710	1295	1100	900	14
CVT-630	1017	676	710	1295	1100	900	14

(*) Recommended pipe nominal diameter

Characteristic curves

Q= Flow rate in m³/h, m³/s and cfm.

Pe= Static pressure in mm H₂O, Pa and inwg.

The Lp noise levels (dB(A)) indicated in the curves are pressures measured at the inlet and in a free field, at 6 metres.

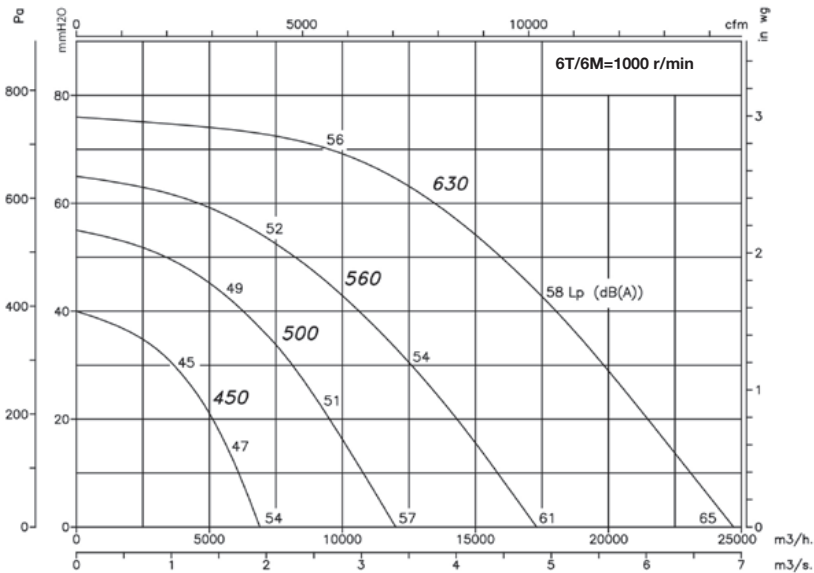
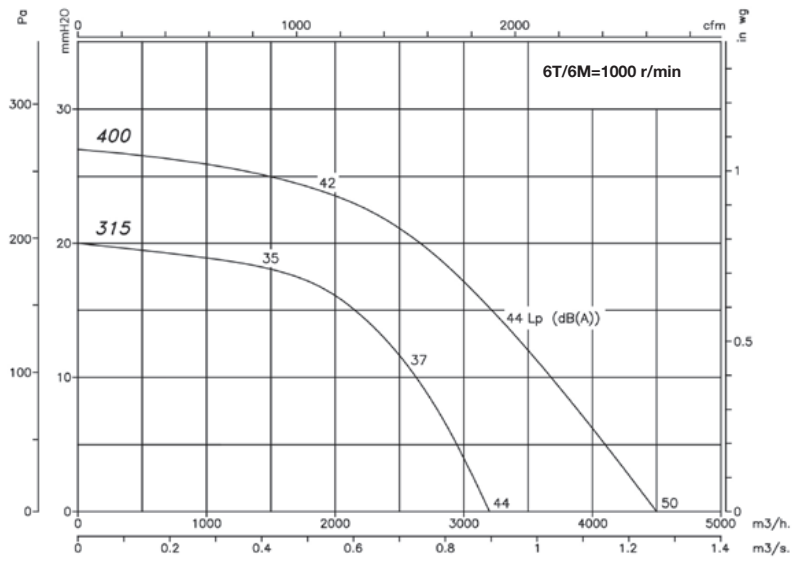
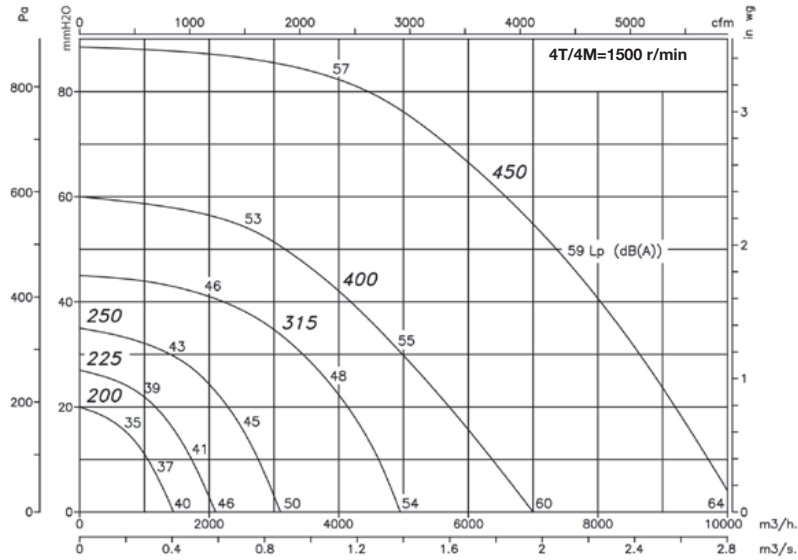

Sound pressure variation depending on distance

The noise level may vary depending on the roof or tile structure.

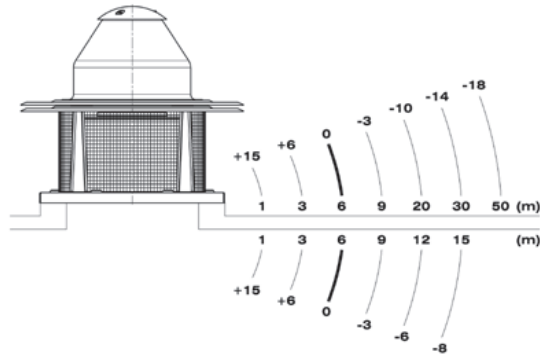

Example of application

Extract fans suitable for use in industrial kitchens

For the correct application of standard:

- C.T.E. Código Técnico de la Edificación (Technical Building Code). Basic Document SI on fire safety. Basic Document HS on health and safety.

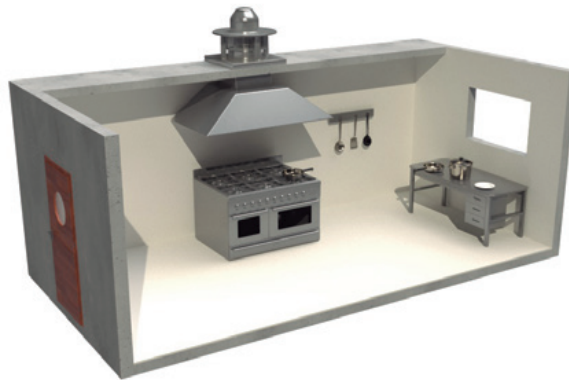

Accessories



CTD

Centrifugal roof-mounted extract fans for household ventilation



Centrifugal roof-mounted household chimney extract fans with low noise level for household ventilation pursuant to the CTE (Technical Building Code).

Fan:

- Sheet steel support base.
- Impeller with reaction blades made of sheet steel.
- Rain cap made of galvanised sheet steel, with corrosion-proof protection.
- Adjustable by voltage change.
- Safety switch provided on request.

Motor:

- Class F motors, external rotor and IP44 protection.
- Single-phase 230V-50Hz.
- Maximum temperature of air to be carried: + 40°C for CTD 125, 150 and 160, + 60°C for CTD 200 and + 65°C for CTD 250 and 315.

Finish:

- Anti-corrosive finish of polyester resin polymerised at 190°C, previously degreased with phosphate-free nanotechnological treatment.

Version B

Version C

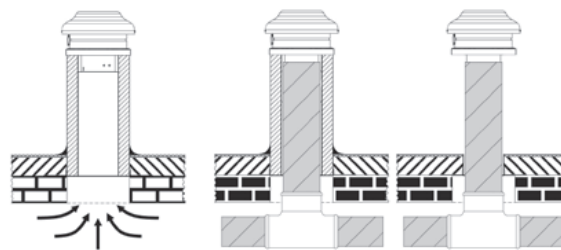

Order code

CTD — 150 — C

CTD: Centrifugal roof-mounted household chimney extract fans

Nominal diameter of conduit

B: Version for base
C: Version for conduit

Technical characteristics

Model	Speed (r/min)	Maximum admissible current (A) 230V	Max. electric power (W)	Maximum flow rate (m ³ /h)	Sound pressure level ⁽¹⁾ at 2/3 Q _{max} dB (A)		Approx. weight (kg)	According to ErP
					Inlet	Exhaust		
CTD_125	2800	0.31	74	456	42	45	4.4	2018
CTD-150	2800	0.31	74	456	42	45	4.4	2018
CTD-160	2800	0.31	74	456	42	45	4.4	2018
CTD-200	2600	0.28	67	636	43	44	6.7	2018
CTD-250	2660	0.60	131	950	45	48	7.6	2018
CTD-315	2700	0.94	220	1170	47	50	7.9	2018

(1) The noise level values are pressures in dB(A) measured at a distance of 6 metres and at 2/3 of the maximum flow rate (2/3 Q_{max}).

Acoustic characteristics

The indicated values are determined by measuring the pressure and noise level in dB(A) obtained in a free field at a distance of 6 m.

Noise power spectrum L_w(A) in dB(A) frequency band in [Hz]

Values measured at inlet with 2/3 maximum flow rate (2/3 Q_{max})

Model	63	125	250	500	1000	2000	4000	8000
CTD-125	38	44	54	59	60	61	57	41
CTD-150	38	44	54	59	60	61	57	41
CTD-160	38	44	54	59	60	61	57	41
CTD-200	39	50	57	63	64	62	58	54
CTD-250	40	52	56	63	64	62	56	51
CTD-315	44	57	59	64	65	63	62	57

Values measured at exhaust with 2/3 maximum flow rate (2/3 Q_{max})

Model	63	125	250	500	1000	2000	4000	8000
CTD-125	28	37	51	54	58	53	47	32
CTD-150	28	37	51	54	58	53	47	32
CTD-160	28	37	51	54	58	53	47	32
CTD-200	31	44	53	57	58	54	50	40
CTD-250	32	44	53	58	61	59	52	43
CTD-315	34	50	55	58	61	59	52	45

Dimensions mm

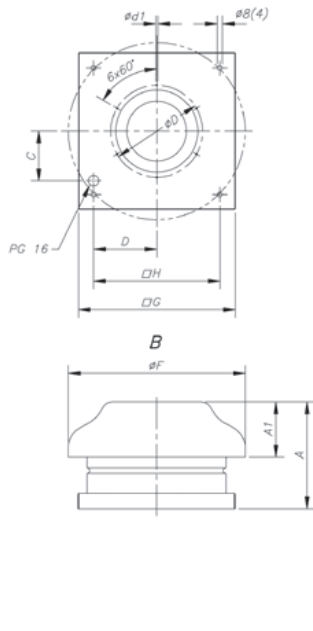

Model	øF	A	A1	øG	øD	ød1	C	D	øH	øO
CTD-125/B	344	207.3	107	305	177	6.1	96.5	123.5	245	-
CTD-150/B	344	207.3	107	305	177	6.1	96.5	123.5	245	-
CTD-160/B	344	207.3	107	305	177	6.1	96.5	123.5	245	-
CTD-200/B	450	214.35	109	405	230	7.1	138	168	330	-
CTD-250/B	450	245.55	109	405	230	7.1	138	168	330	-
CTD-315/B	450	245.55	109	405	230	7.1	138	168	330	-
CTD-125/C	344	207.3	107	305	177	6.1	96.5	123.5	245	147
CTD-150/C	344	207.3	107	305	177	6.1	96.5	123.5	245	147
CTD-160/C	344	207.3	107	305	177	6.1	96.5	123.5	245	157
CTD-200/C	450	214.35	109	405	230	7.1	138	168	330	197
CTD-250/C	450	245.55	109	405	230	7.1	138	168	330	247
CTD-315/C	450	245.55	109	405	230	7.1	138	168	330	312

Characteristic curves

Q= Flow rate in m³/h, m³/s and cfm.

Pe= Static pressure in mm H₂O, Pa and inwg.

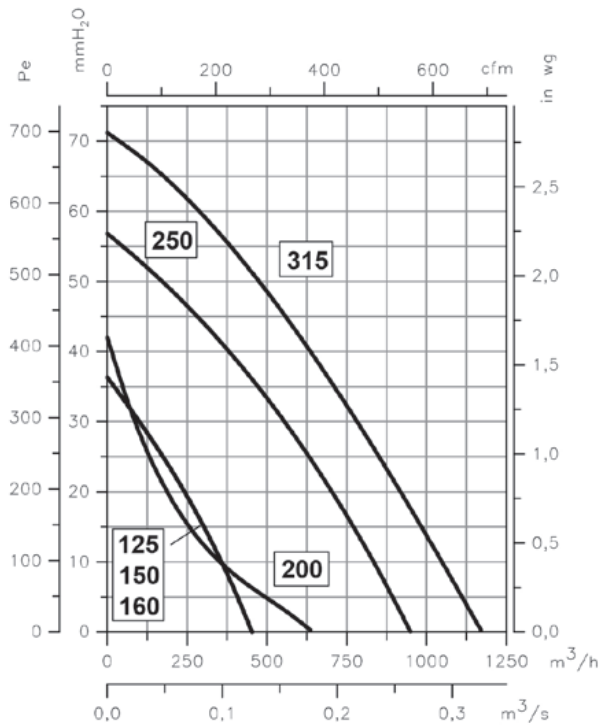

On request

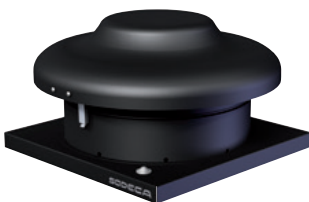

INT
Safety switch

TIRACANO

Chimney smoke extract fans



- Designed specially for smoke extraction from chimneys and barbecues at temperatures of up to 200°C.
- Fitted with an electronic regulator that adjusts the speed and flow rate of the extract fan, depending on the real smoke extraction needs.
- Designed for continuous operation at 200°C.

Construction:

- Galvanised sheet steel support base.
- Impeller with reaction blades made of galvanised sheet steel.
- Bird guard.
- Aluminium rain cover.
- Bird guard.
- Supply voltage 230V. 50 Hz

Motor:

- Single-phase 230V 50/60Hz.

Technical characteristics

Model	Speed (r/min)	Maximum admissible current (A) 230V	Installed power (kW)	Maximum flow rate (m ³ /h)	Sound pressure level (*)	Approx. weight (kg)
TIRACANO	1400	0.90	0.09	955	52	17

(*) The noise level values are pressures in dB(A) measured at a distance of 3 metres and at maximum flow rate

Dimensions mm

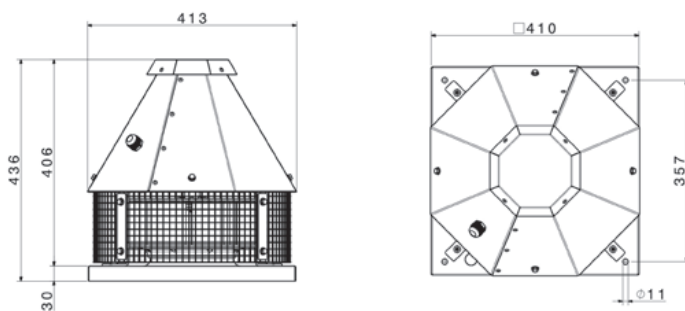

Characteristic curves

Q= Flow rate in m³/h, m³/s and cfm.

Pe= Static pressure in mm H₂O, Pa and inwg.

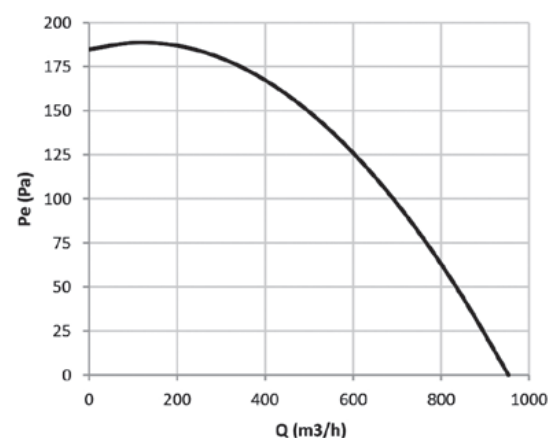

RCH

Chimney extract fan and cap for hybrid extraction in community housing



SI-VENT accessories

- Specially designed for air extraction in detached or community homes through chimneys or community shunts. It gives the whole building a uniform, attractive appearance.
- The Venturi version is only for natural extraction, without an extract fan.
- Its lightweight aluminium structure means it can be easily and quickly installed on the roof.

Construction:

- Made of pre-lacquered black aluminium that cannot be altered by atmospheric elements.

- Slats specially designed to obtain a high-performance Venturi effect.
- Supply voltage 230V 50 Hz.

Versions:

- BASIC: Operated with a switch or a SI-VENT wind controller.
- VENTURI: Natural operation without an extract fan due to the Venturi effect.
- TEMPERATURE: Designed for air extraction in homes and barbecues at temperatures of up to 150°C.

On request:

- Measurements adapted to any chimney.



HYBRID VENTILATION SYSTEM (H.V.)

This system is based on natural air extraction when the external wind conditions are favourable and when they are unfavourable the extract fan operates with an electric motor, guaranteeing the minimum necessary extraction. The electric extract fan is started up by wind control sensors specially designed for this application.



SI-VENT accessories

WIND CONTROLLER

SI-VENT, Wind sensor

The SI-VENT electronic wind controller is extremely robust and reliable. It is made up of a sensor, a controller and a power source.

The sensor is able to measure winds of up to 100 km/h and the controller starts up the electric extract fan when the wind speed remains below the minimum programmed speed for a period of 5 minutes.

RCH-400x800VM

Chimney extract fan and cap for hybrid extraction in community housing



A unit specially designed for controlled mechanical extraction through chimneys or community shunts. The system enables a constant pressure to be maintained in the installation, with self-regulation of the extract fan speed, obtaining the necessary flow rate at each given time, depending on the different needs of the installation, and achieving important energy savings.

- It gives the whole building a uniform, attractive appearance.
- Its lightweight aluminium structure means it can be easily and quickly installed on the roof.
- Measurements adapted to any chimney, on request.

Construction:

- Made of pre-lacquered black aluminium that cannot be altered by atmospheric elements.

- Slats specially designed to obtain a high-performance Venturi effect.
- Reaction blades impeller with external rotor motor.
- Adjustable 0-250Pa differential pressure transmitter with digital display and connection accessories.
- VSD1/A-RFM-0.5 frequency converter speed controller.

Motor:

- Motor with durable ball bearings and IP54 protection.
- Converter power, single-phase 230V 50 Hz, converter to motor output voltage three-phase 230V. 50Hz
- Operating temperature -20°C +50°C.

Technical characteristics

Model	Speed (r/min)	Maximum admissible current (A)		Installed power (kW)	Maximum electric power (kW)	Maximum flow rate (m³/h)	Sound pressure level ⁽¹⁾ at 2/3 of Qmax dB(A)		Useful surface (m²)	Approx. weight (kg)	According to ErP
		230V	400V				Inlet	Exhaust			
RCH-400x400B	1360	0.34	-	-	0.08	950	32	35	-	9	2018
RCH-400x400V									0.134	6.7	Excluded
RCH-400x600B	910	0.35	-	-	0.08	1280	28	31	-	14	2018
RCH-400x600V									0.191	9.5	Excluded
RCH-400x800B	880	0.50	-	-	0.12	1800	31	35	-	18	2018
RCH-400x800V									0.248	13.5	Excluded
RCH-400x800VM	1280	-	0.55	-	0.20	2500	43	48	-	19	2018

(1) The noise level values are pressures in dB(A) measured at a distance of 6 metres and at 2/3 of the maximum flow rate (2/2 Qmax).

Dimensions mm

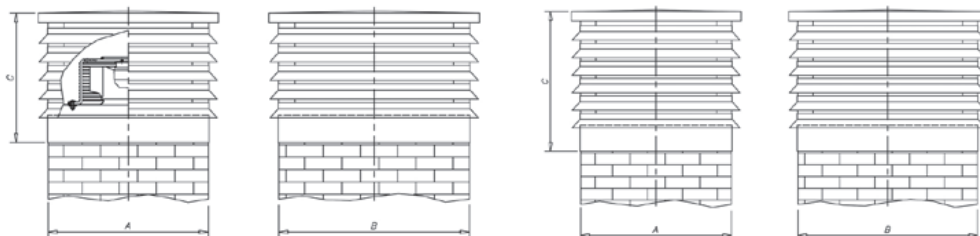

Model	A	B	C
RCH-400x400B	400	400	420
RCH-400x600B	400	600	420
RCH-400x800B	400	800	420
RCH-400x800VM	400	800	420

Model	A	B	C	Useful surface area
RCH-400x400V	400	400	600	0,134 m²
RCH-400x600V	400	600	600	0,191 m²
RCH-400x800V	400	800	600	0,248 m²

AXIAL FANS AND ROOF-MOUNTED EXTRACT FANS

Characteristic curves

Q= Flow rate in m³/h, m³/s and cfm.

Pe= Static pressure in mm H₂O, Pa and inwg.

RCH

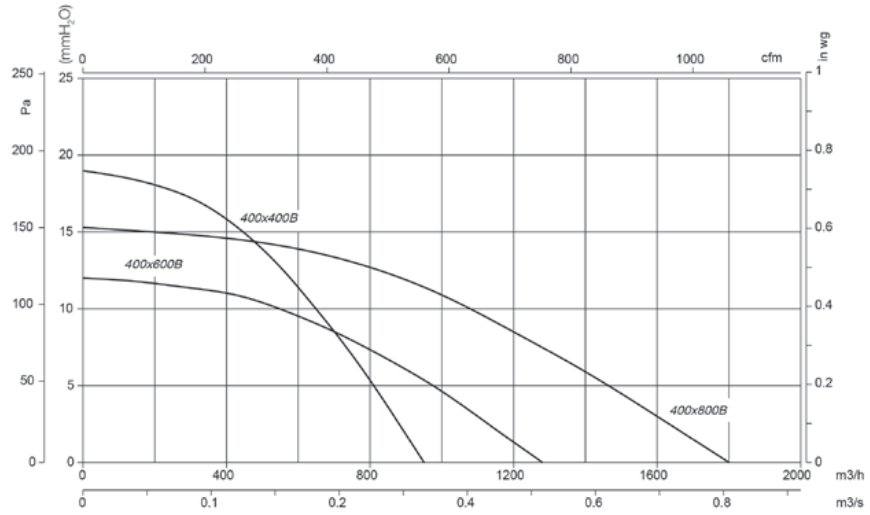

RCH-400x800VM

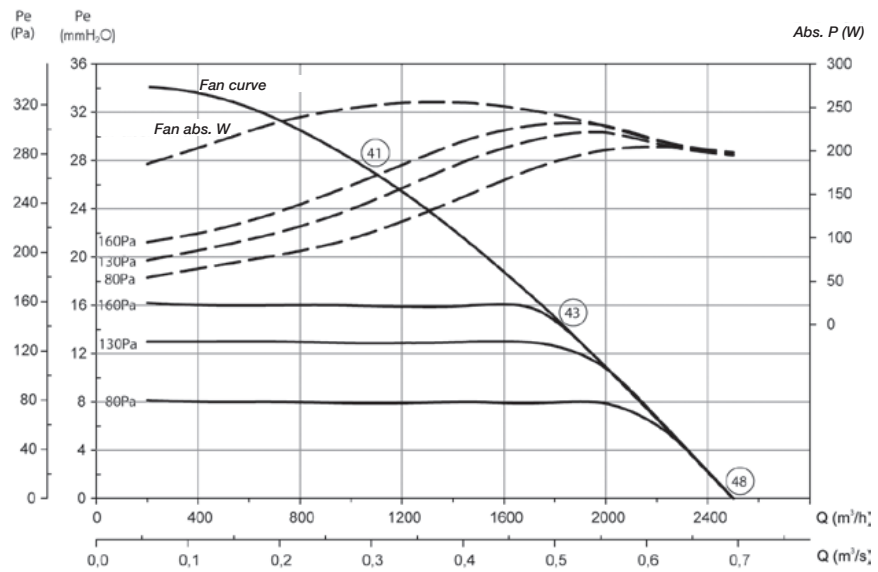

○ The LpA noise levels indicated in the curves are pressures measured at the inlet and in a free field, at 6 metres.

Examples of operation

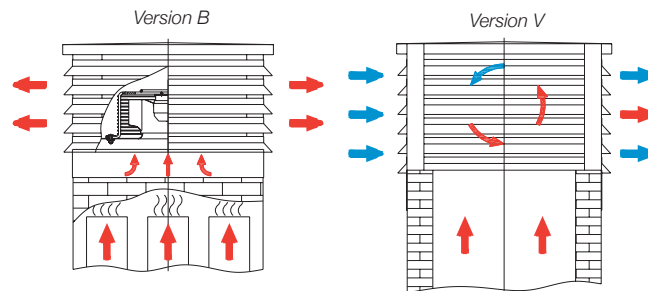

AXIAL ACCESSORIES

160 INT
Stop-start safety switches
compliant with standard
UNE-EN 60204-1.



160 RM
Electronic speed
controllers.



160 C2V
Change-over switch for
2-speed motors.



**160 VSD3/A-RFT
VSD1/A-RFM**
Frequency converters for
three-phase 400V motors.



161 GMP
Electrical panel for fan
start-up and fan protection
with three-phase motors.



**161 ELECTRIC
CONTROL PANELS**
Electric control panels.



161 MTP
0-10V brushless motor
speed control.



162 PL
Overpressure blinds made
of plastic material.



162 P
Overpressure blinds made
of aluminium.



162 P-400
Overpressure blinds,
400°C/2h-certified.



162 R
Protective grille for axial
fan inlet.



162 RI
Protective grille for axial
fan impulsion.



163 RT
Protective grille for tubular
axial fan inlet or impulsion.



163 PV
Inlet duct applicable to
series HEPT, HCT, HGT,
HTP, THT.



163 BTUB
Coupling flange for
axial fans.



163 B
Coupling flange for
centrifugal fans.



164 BAC
Double and elastic flange
for axial fans.



164 PS
Support feet unit
for tubular fans.



164 MS
Support frame for easier
mounting on site.



164 PA
Adjustment plate for
mounting accessories, in
roof-mounted extract fans.



165 BS BSS
Galvanised sheet steel
raised support base.



165 PT PT/H PT-400
Self-closing plugs for vertical
and horizontal work version
400, 400°C/2h-certified.



165 OP
Overpressure plugs for
roof-mounted extract fans.



165 REG
Manual regulation chamber.



166 S
Silencers for coupling to
inlet or impulsion.



167 MOTORS
Asynchronous three-phase
motors.



**168 SMART
SENSORS**





INT Stop-start safety maintenance switches compliant with standard UNE-EN 60204-1

- Characteristics:
- Switches for installation next to fan, to shut off the current before handling the fan.
 - IP65 protection.
 - Single-phase or three-phase fans, use 3-pole switch (3CA).
 - Three-phase or 2-speed fans, use 6-pole switch (6CA).

Model	Current (A)	(kW)	Cable entry (mm)	Model	Current (A)	(kW)	Cable entry (mm)
INT-KG 20/3CA	25	7.5	29	INT-KG 20/6CA	25	7.5	29
INT-KG 41/3CA	40	15	37.5	INT-KG 41/6CA	40	15	37.5
INT-KG 64/3CA	63	22	37.5	INT-KG 64/6CA	63	22	37.5
INT-KG 80/3CA	80	30	37.5	INT-KG 80/6CA	80	30	37.5
INT-KG 100/3CA	100	37	37.5	INT-KG 100/6CA	100	37	37.5



RM Electronic speed controllers for single-phase motors

The RM models are voltage-regulated. The RM/VSD1 models are frequency-regulated.

- Common characteristics:
- Variable speed drives for fans with asynchronous single-phase motors.
 - Speed drive power supply single-phase 230V 50/60 Hz.
 - Start-stop switch.
 - Speed adjustment by means of analogue control.
 - Compliant with EM Compatibility.
 - 2014/30/EC and Low Voltage 2014/35/EC Directives.

- RM model characteristics:
- Minimum speed adjustment.
 - With EMC filters in accordance with Standard EN-55014.

- RM/VSD1 model characteristics:
- 16AF protective fuse.
 - Dual passive (radiator) and active (cooling fan) heat dissipation system.

Model	Regulation type	Input voltage	Output voltage	Protection	Maximum current (A)
RM-00	Voltage	230 V-50/60Hz	230 V-50/60Hz	IP-44	0.5
RM-01	Voltage	230 V-50/60Hz	230 V-50/60Hz	IP-44	1
RM-02	Voltage	230 V-50/60Hz	230 V-50/60Hz	IP-44	2
RM-1	Voltage	230 V-50/60Hz	230 V-50/60Hz	IP-54	3
RM-2	Voltage	230 V-50/60Hz	230 V-50/60Hz	IP-54	5
RM-3	Voltage	230 V-50/60Hz	230 V-50/60Hz	IP-54	10
RM/VSD1-3.5	Frequency	230 V-50/60Hz	230 V-35/50 Hz	IP-20	3.5
RM/VSD1-8.0	Frequency	230 V-50/60Hz	230 V-35/50 Hz	IP-20	8

Model	A	B	C
RM-00	81	81	66
RM-01	81	81	66
RM-02	81	81	66
RM-1	80	145	80
RM-2	96	164	85
RM-3	96	164	85
RM/VSD1-3.5	200	180	100
RM/VSD1-8.0	200	225	100

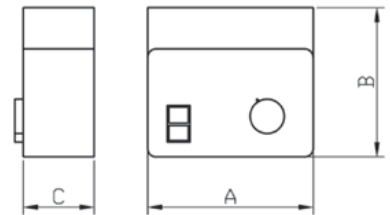

C2V Change-over switch for 2-speed motors

- Characteristics:
- 1-0-2 3-position switch for operating 2-speed Dahlander connection motors.
 - IP67 protection

Model	Current (A)	(kW)	Cable entry (mm)
C2V-CG10 A441	20	5.5	20

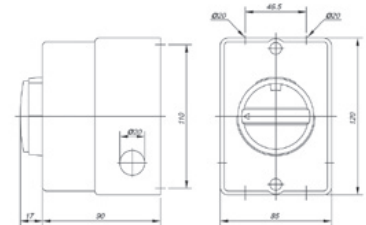

VSD1/A-RFM VSD3/A-RFT Electronic variable speed drives for AC motors

- Characteristics:
- Variable speed converters via voltage and frequency, for axial and centrifugal fans with asynchronous three-phase motors.
 - Converter power supply:
 - . Single-phase (VSD1/A-RFM): 200-240V 50/60 Hz
 - . Three-phase (VSD3/A-RFT): 380-480V 50/60 Hz
 - Based on EU EM Compatibility Directive 2014/30/EU, Low Voltage Directive 2014/35/EU and Machinery Safety Directive 2006/42/EU.
 - Pursuant to: EN 61800-3: Adjustable speed electrical power drive systems. EMC-related product standard including specific test methods. EN 61800-5-1: Adjustable speed electrical power drive systems. Safety requirements. Electrical, thermal and power. EN 60204-1: Machinery safety. Electrical equipment of machines. General requirements. EN 55011: Limits and methods for the measurement of characteristics relating to radioelectric perturbations of industrial, scientific and medical equipment (ISM) that generates radiofrequency energy. EN 60529: Specification for degrees of protection in enclosures.
 - Stop/start input for disabling/enabling converter.
 - 0-10V input for speed control.
 - ModBus RTU bus connection available.
 - Standard model with IP20 protection. Also available in IP66 version up to 10 HP.
 - For powers higher than 15 HP only available with IP55 protection.

1. In general, all SODECA fans with three-phase motors are adequate for operating supplied with a static frequency converter in normal execution (based on IEC 60034-17). However some motors require special measures. The maximum operating frequency or speed must never exceed that of the fan design. In applications with a quadratic torque such as fans and pumps, when the speed changes, the absorbed power is directly proportional to the rotation speed cube: $P_a = P_{a1} (n_2 / n_1)^3$.
2. The insulation of the motors coupled to the fans is sufficient to work without restrictions with the frequency converter up to voltages of < 500V. The use of sinusoidal filters at the converter output will contribute to the correct operation of the motor, reducing failures and increasing its useful life. It is advisable that for > 225 size motors, these are requested with special windings for operating with a frequency converter.
3. The length of the output cable from the converter to the fan has an important effect on the voltage characteristics in the motor terminals. The definition "long cables" will depend on the nominal value and type of converter, and the technical document of the manufacturer must be consulted.
4. Ex-d explosion-proof motors must be requested for activation with a frequency converter. The motor manufacturer should request information on the application using a questionnaire, to define the working parameters. Furthermore, these motors must have built-in TPC sensors.
5. Ex-e increased safety motors cannot be activated with a frequency converter (this would require the joint motor-converter certification).

VSD1/A-RFM

Model	VSD1/A-RFM-0.5	VSD1/A-RFM-1	VSD1/A-RFM-2	VSD1/A-RFM-3
Power (HP)	0.50	1.00	2.00	3.00
Power (kW)	0.37	0.75	1.50	2.20
Maximum current (A)	2.3	4.3	7.0	10.5
Inlet				
Inlet type	Single-phase	Single-phase	Single-phase	Single-phase
Voltage (V)	200-240V	200-240V	200-240V	200-240V
Frequency (Hz)	50-60 Hz	50-60 Hz	50-60 Hz	50-60 Hz
Outlet				
Outlet type	Three-phase	Three-phase	Three-phase	Three-phase
Voltage (V)	200-240V	200-240V	200-240V	200-240V
Frequency (Hz)	0-500 Hz	0-500 Hz	0-500 Hz	0-500 Hz
Degrees of protection	Standard: IP20 On request: IP66			
Cooling	IP20: Forced IP66: Natural			

VSD3/A-RFT

Model	VSD3/A-RFT-1	VSD3/A-RFT-2	VSD3/A-RFT-3	VSD3/A-RFT-5.5	VSD3/A-RFT-7.5	VSD3/A-RFT-10	VSD3/A-RFT-15	VSD3/A-RFT-20	VSD3/A-RFT-25	VSD3/A-RFT-30
Power (HP)	1.00	2.00	3.00	5.50	7.50	10.00	15.00	20.00	25.00	30.00
Power (kW)	0.75	1.50	2.20	4.00	5.50	7.50	11.00	15.00	18.50	22.00
Maximum current (A)	2.2	4.1	5.8	9.5	14.0	18.0	24.0	30.0	39.0	46.0
Inlet										
Inlet type	Three-phase	Three-phase	Three-phase	Three-phase	Three-phase	Three-phase	Three-phase	Three-phase	Three-phase	Three-phase
Voltage (V)	380-480V	380-480V	380-480V	380-480V	380-480V	380-480V	380-480V	380-480V	380-480V	380-480V
Frequency (Hz)	50-60 Hz	50-60 Hz	50-60 Hz	50-60 Hz	50-60 Hz	50-60 Hz	50-60 Hz	50-60 Hz	50-60 Hz	50-60 Hz
Outlet										
Outlet type	Three-phase	Three-phase	Three-phase	Three-phase	Three-phase	Three-phase	Three-phase	Three-phase	Three-phase	Three-phase
Voltage (V)	380-480V	380-480V	380-480V	380-480V	380-480V	380-480V	380-480V	380-480V	380-480V	380-480V
Frequency (Hz)	0-500 Hz	0-500 Hz	0-500 Hz	0-500 Hz	0-500 Hz	0-500 Hz	0-500 Hz	0-500 Hz	0-500 Hz	0-500 Hz
Protection grades	Standard: IP20 On request: IP66						IP20	IP20	IP20	IP20
Cooling	IP20 and IP55: Forced IP66: Natural									



GMP

Electrical panel for fan start-up and fan protection with three-phase motors and stop-start push buttons

Characteristics:

- Start-up and stop by means of push button.
- With fully wired contactor and adjustable thermal relay for motor protection.
- The stop button is used to rearm the thermal relay in the event of triggering due to overload.
- Surface mount, IP-55 protection.

For fan with 230V three-phase motor

Model	Regulation current (A)	Motor power 3x230V (kW)
GMP-0.2-0.33/230	1.2-1.8	0.25
GMP-0.2-0.75/230	1.8-2.8	0.37 / 0.55
GMP-0.2-1/230	2.8-4	0.75
GMP-0.2-1.5/230	4-6.3	1.10
GMP-0.2-2/230	5.6-8	1.50
GMP-0.4-3/230	7-10	2.20
GMP-0.4-4/230	8-12.5	3.00
GMP-0.4-5.5/230	11-17	4.00
GMP-0.4-7.5/230	15-23	5.50
GMP-0.4-10/230	22-32	7.50
GMP-0.6-12.5/230	25-40	9.20
GMP-0.6-15/230	25-40	11.00

For fan with 400V three-phase motor

Model	Regulation current (A)	Motor power 3x400 V (kW)
GMP-0.2-0.33/400	0.56-0.8	0.25
GMP-0.2-0.5/400	0.8-1.2	0.37
GMP-0.2-0.75/400	1.2-1.8	0.55
GMP-0.2-1.5/400	1.8-2.8	1.10
GMP-0.2-2/400	2.8-4	1.50
GMP-0.2-3/400	4-3	2.20
GMP-0.2-4/400	5.6-8	3.00
GMP-0.4-5.5/400	7-10	4.00
GMP-0.4-7.5/400	8-12.5	5.50
GMP-0.4-10/400	11-17	7.50
GMP-0.6-12.5/400	15-23	9.20
GMP-0.6-15/400	15-23	11.00
GMP-0.6-20/400	22-32	15.00
GMP-0.6-25/400	25-40	18.50



AET

Electric panel with star/triangle starter and three-phase fan protection, with stop and start push buttons

Characteristics:

- Start-up and stop by means of push button.
- View of status through luminous pilot lamps.
- With adjustable thermal relay for motor protection.
- Fully wired.
- Metal box for surface mounting, IP-65 protection.

For fan with three-phase 400V/690V motor 3x400V+N power supply

Model	Thermal relay adjustment current (A)	Motor power 3x400 V/690 V (kW)	Model	Thermal relay adjustment current (A)	Motor power 3x400 V/690 V (kW)
AET-01-5.5/400	4-6.3	4	AET-01-30/400	18-26	18.5/22.0
AET-01-7.5/400	5-8	5.5	AET-01-40/400	28-40	30
AET-01-10/400	7-10	7.5	AET-02-50/400	34-50	37
AET-01-15/400	12-18	11	AET-02-60/400	45-65	45
AET-01-20/400	12-18	15	AET-02-75/400	45-65	55



MTP

0-10 V E.C. Technology brushless motor speed control

- Power meter for fan speed control fitted with 0-10 V DC brushless motor.
- Gradually delivers a voltage of between 0 and 10 V DC.
- It may be used as a switch.
- Moisture-repellent body.
- Option of flush or recessed mounting.



PL Overpressure blinds made of plastic material

- Characteristics:
- The overpressure blind is fitted directly over the wall where the fan is installed.
 - Opening by overpressure due to air flow.
 - They close when the fan is at rest.
 - Made from plastic material.
 - Maximum speed recommended 12m/sec. for models 80, 90 and 100.

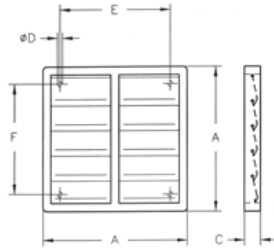

Model	A	C	ØD	E	F
PL-20	240	28	5.2	193	167
PL-25	294	26	5	232	232
PL-31	347	26	5	276	276
PL-35	397	26	5	310	310
PL-40	459	26	5	364	364
PL-45	501	26	5	395	395
PL-50	549	31	5	445	445
PL-56	605	28	5	522	522
PL-63	696	31	5	626	626
PL-71	760	40	5	692	692
PL-80	840	40	5	772	772
PL-90	940	40	5	872	87
PL-100	1040	40	5	972	972



P Overpressure blinds made of aluminium

- Characteristics:
- The overpressure blind is fitted directly over the wall where the fan is installed.
 - Aperture by overpressure due to air flow.
 - They close when the fan is at rest.
 - Made of aluminium sheet metal except for models 125 and 140, which are made of galvanised sheet steel.
 - Maximum speed recommended 18m/sec. for 90, 100, 125 and 140 models.

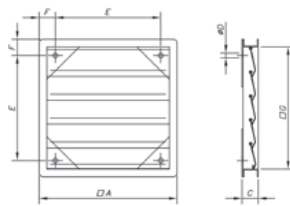

Model	G	A	C	ØD	E	F
P 25	240	290	51	6	180	55
P 35	350	400	51	6	290	55
P 45	450	500	51	6	390	55
P 56	550	600	51	6	440	80
P 63	645	715	72	6	555	80
P 71	710	780	72	6	620	80
P 80	805	875	72	6	695	90
P 90	900	970	72	6	790	90
P 100	1000	1070	72	6	890	90
P 125	1406	1486	102	6	1304	90
P 140	1506	1586	102	6	1366	110



P-400 Overpressure blinds, 400°C/2h-certified

- Characteristics:
- Supplied ready-mounted in the box with its respective adaptor.
 - Approved in accordance with standard EN-12101-3, with certificate number: 0370-CPR-0312.
 - Frame made of aluminium sheet metal, except for models 125 and 140, which are made of galvanised sheet steel.
 - Can be used for other 400°C/2h applications.

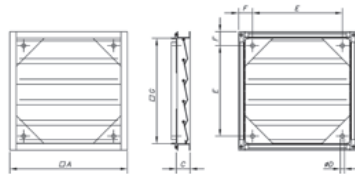

Model	G	A	C	ØD	E	F
P-400-56	565	615	51	6	455	80
P-400-63	690	760	72	6	600	80
P-400-80	850	920	72	6	740	90
P-400-100	1050	1120	72	6	940	90
P-400-125	1400	1486	102	6	1306	90
P-400-140	1500	1586	102	6	1366	110



R Protective grille for axial fan inlet

Model	HC	HCH
R-35/B	-	35
R-40	-	40
R-45	-	45
R-56	-	56-4T-0.75; 56-4T-1; 56-6T-0.33; 56-6T-0.5; 56-6T-0.75
R-56-1.5	-	56-4T-1.5; 56-4T-2
R-63-0.5	-	63-4T-1; 63-6T-0.5; 63-6T-0.75
R-63-1.5	-	63-4T-1.5; 63-4T-2; 63-6T-1
R-63-4	-	63-4T-3; 63-4T-4
R-71	-	71-4T-1.5; 71-4T-2; 71-6T-0.75; 71-6T-1; 71-6T-1.5
R-71/C*	71	-
R-71-3	-	71-4T-3; 71-4T-4

Model	HC	HCH
R-80	-	80-6T-1; 80-6T-1.5
R-80/C*	80	-
R-80-5.5	-	80-4T-3; 80-4T-4; 80-4T-5.5; 80-6T-2; 80-6T-3
R-90	-	90-4T-4; 90-4T-5.5; 90-6T-3
R-90/C*	90	-
R-90-7.5	-	90-4T-7.5; 90-4T-10; 90-6T-4
R-100	-	100-6T-3
R-100/C*	100	-
R-100-7.5/C*	100	4T/H -
R-100-10	-	100-4T-7.5; 100-4T-10; 100-6T-4; 100-6T-5.5
R-100-20	-	100-4T-15; 100-4T-20

* These models are supplied with a square grille.



RI Protective grille for axial fan impulsion

Model	HEP	HCD	HC	HRE	HCH	HCDF	HDF
RI-20	-	20	-	-	-	-	-
RI-25/E	-	-	-	25	-	-	-
RI-25	25	25	25	-	-	25	-
RI-31/E	-	-	-	31	-	-	-
RI-31	31	30	31	-	-	31	-
RI-35/E	-	-	-	35	-	-	-
RI-35/B	-	-	-	-	35	-	-
RI-35/C	35	35	35	-	-	35	-
RI-40	40	40	40	-	40	40	-

Model	HEP	HCD	HC	HRE	HCH	HCDF	HDF
RI-45	45	-	45	-	45	45	-
RI-50	50	-	50	-	-	50	-
RI-56	56	-	56	-	56	56	-
RI-63	63	-	63	-	63	-	63
RI-71	-	-	71	-	71	-	71
RI-80	-	-	80	-	80	-	80
RI-90	-	-	-	-	90	-	90
RI-90/C	-	-	90	-	-	-	-
RI-100	-	-	100	-	100	-	100



RT Protective grille for tubular axial fan inlet or impulsion

Model	HEPT*	HCT	HGT	HPX	Model	HEPT*	HCT	HGT	HPX	Model	HEPT*	HCT	HGT	HPX
RT-25	-	25	-	-	RT-45	45	45	-	45	RT-80	-	80	-	80
RT-31/B	-	31	-	-	RT-50	50	50	-	50	RT-90	-	90	-	90
RT-31	31	-	-	-	RT-56	56	56	-	56	RT-100	-	100	-	100
RT-35	35	35	-	35	RT-63	63	63	-	63	RT-125	-	-	125	-
RT-40	40	40	-	-	RT-71	-	71	-	71	RT-125/CC	-	-	125	-

* In the HEPT series, can only be fitted in the impulsion.



PV Inlet duct applicable to series HEPT, HCT, HGT, HTP

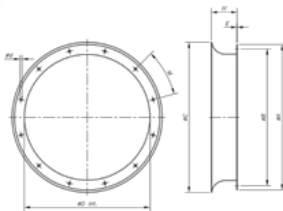

Model	øA	øB	ØC	øD	ød	E	M	H	Model	øA	øB	ØC	øD	ød	E	M	H
PV-31	398	355	426	320	10	1.5	8x45°	165	PV-80	904	860	915	797	12	2	16x22.5°	250
PV-35	438	395	435	359	10	1.5	8x45°	165	PV-90	1004	970	1015	894	14	2	16x22.5°	250
PV-40	484	450	507	401	12	1.5	8x45°	165	PV-100	1105	1070	1115	1003	14	2	16x22.5°	250
PV-45	534	500	555	450	12	1.5	8x45°	165	PV-125	1370	1320	1364	1240	14	2	20x18°	250
PV-50	584	560	617	504	12	1.5	12x30°	165	PV-140	1533	1470	1673	1413	15	3	20x18°	250
PV-56	664	620	667	565	12	1.5	12x30°	165	PV-160	1705	1680	1866	1585	19	3	24x15°	315
PV-63	734	690	757	634	12	1.5	12x30°	165	PV-180	1908	1830	1923	1788	19	3	24x15°	315
PV-71	812	770	816	711	12	2	16x22.5°	250	PV-200	2113	2080	2128	1993	19	3	24x15°	315



BTUB Coupling flange for axial fans

Model	HEPT	HCT	HGT	HPX	HT*	Model	HEPT	HCT	HGT	HPX	HT*	Model	HEPT	HCT	HGT	HPX	HT*
BTUB-250	-	25	-	-	25	BTUB-500	50	50	-	50	50	BTUB-1000	-	100	-	100	100
BTUB-280	-	31	-	-	-	BTUB-560	56	56	-	56	56	BTUB-1250	-	-	125	-	-
BTUB-315	31	-	-	-	31	BTUB-630	63	63	-	63	63	BTUB-1400	-	-	140	-	-
BTUB-355	35	35	-	-	35	BTUB-710	-	71	-	71	71	BTUB-1600	-	-	160	-	-
BTUB-400	40	40	-	-	40	BTUB-800	-	80	-	80	80						
BTUB-450	45	45	-	45	45	BTUB-900	-	90	-	90	90						

* The PA accessory must be used to install it.



B Coupling flange for centrifugal fans

Characteristics:

- Fitted to the inlet and impulsion nozzle.
- Facilitates in-duct installation.

Model	CHT/CVT	CRF	Model	A	C	F	Model	A	C	F	Model	A	C	F
B-160/1	-	225	B-52-E	100	52	67	B-280/2	350	280	80	B-500/4	590	500	80
B-180	-	250	B-63	110	63	60	B-280/3	350	280	80	B-500/5	590	500	80
B-250/3	200/225	315	B-80	150	80	60	B-280/4	350	280	80	B-560/1	650	560	80
B-355/3	250/315	355/400	B-80-E	150	80	60	B-315/1	380	315	80	B-560/2	650	560	80
B-500/4	400/450	450/500	B-100	150	100	60	B-315/2	380	315	80	B-560/3	650	560	80
B-630/3	500	-	B-100-E	170	100	60	B-315/3	380	315	80	B-560/4	650	560	80
B-710/2	560/630	-	B-112	160	112	60	B-315/4	380	315	80	B-560/5	650	560	80
			B-125	180	125	60	B-315/6	380	315	80	B-630/1	720	630	80
			B-140	190	140	60	B-355/1	430	355	80	B-630/2	720	630	80
			B-150	210	150	60	B-355/2	430	355	80	B-630/3	720	630	80
			B-160	220	160	60	B-355/3	430	355	80	B-630/4	720	630	80
			B-160/1	220	160	60	B-355/4	430	355	80	B-630/5	720	630	80
			B-180	240	180	60	B-400/1	480	400	80	B-710/1	800	710	80
			B-180/1	240	180	60	B-400/2	480	400	80	B-710/2	800	710	80
			B-200	260	200	60	B-400/3	480	400	80	B-710/3	800	710	80
			B-224	280	224	60	B-400/4	480	400	80	B-800	890	800	100
			B-228	280	224	60	B-450/1	530	450	80	B-900/1	1000	900	100
			B-250/1	310	250	80	B-450/2	530	450	80	B-1000/1	1100	1000	100
			B-250/2	310	250	80	B-450/3	530	450	80	B-1130	1250	1130	100
			B-250/3	310	250	80	B-450/4	530	450	80	B-1260	1380	1260	100
			B-250/4	310	250	80	B-500/1	590	500	80	B-1410	1530	1410	100
			B-250/5	310	250	80	B-500/2	590	500	80	B-1610	1730	1610	100
			B-280/1	350	280	80	B-500/3	590	500	80				

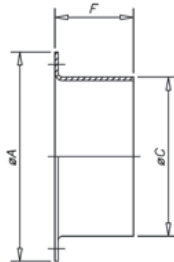



BAC Double and elastic flange for axial fans

- Characteristics:
- Fitted to the inlet and impulsion nozzle.
 - Facilitates in-duct installation with flange.
 - Prevents the transmission of vibrations.

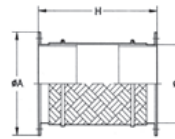

Model	HEPT	HCT	HGT	CHT	CVT	HT	HPX	CRF
BAC-160	-	-	-	-	-	-	-	225
BAC-180	-	-	-	-	-	-	-	250
BAC-250	-	25	-	200/225	25	-	-	315
BAC-315/B	-	31	-	-	-	-	-	-
BAC-315	31	-	-	-	-	31	-	-
BAC-355	35	35	-	250/315	35	35	355/400	-
BAC-400	40	40	-	-	40	-	-	-
BAC-450	45	45	-	-	-	45	45	-

Model	HEPT	HCT	HGT	CHT	CVT	HT	HPX	CRF
BAC-500	50	50	-	400/450	50	50	450/500	-
BAC-560	56	56	-	-	-	56	56	-
BAC-630	63	63	-	500	63	63	-	-
BAC-710	-	71	-	560/630	71	71	-	-
BAC-800	-	80	-	-	-	80	80	-
BAC-900	-	90	-	-	-	90	90	-
BAC-1000	-	100	-	-	-	100	100	-
BAC-1250	-	-	125	-	-	-	-	-

Model	ØD*	ØA*	H
BAC-160	160	220	340
BAC-180	180	240	340
BAC-250	250	310	340
BAC-315/B	280	350	340
BAC-315	315	380	340
BAC-355	355	430	340
BAC-400	400	480	340
BAC-450	450	530	340
BAC-500	500	590	340
BAC-560	560	650	340
BAC-630	630	720	340
BAC-710	710	800	340
BAC-800	800	890	340
BAC-900	900	1000	340
BAC-1000	1000	1100	340
BAC-1250	1250	1365	340

*Nominal pipe diameter.



PS Support feet unit for tubular fans

- Characteristics:
- When attached to the flange, facilitates anchoring on flat surfaces.

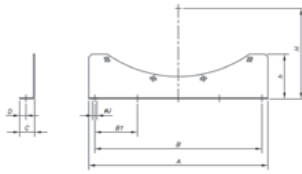

Model	A	B	B1	C	D	h	H	ØJ	HEPT	HCT	HGT	HPX	THT
PS-25/31	275	225	-	25	10.5	90	165	10	-	25	-	-	-
	275	225	-	25	10.5	90	191.5	10	-	31	-	-	-
	275	225	-	25	10.5	90	205	10	31	-	-	-	-
PS-35/40	240	200	-	30	13	60	230	10	35	35	-	35	-
	240	200	-	30	13	60	255.5	10	40	40	-	-	40
PS-45/50	450	400	200	35	14.5	125	278	12	45	45	-	45	45
	450	400	200	35	14.5	125	305	12	50	50	-	50	50
PS-56/63	520	430	215	40	17	155	338	13	56	56	-	56	56
	520	430	215	40	17	155	385.5	13	63	63	-	63	63
PS-71	490	450	225	50	21	150	445	13	-	71	-	71	71
PS-80	600	560	280	50	21	150	490	13	-	80	-	80	80
PS-90	620	560	280	60	28	175	547.5	18	-	90	-	90	90
PS-100	680	560	280	60	28	185	597.5	18	-	100	-	100	100
PS-125 <20CV	1000	1200	3x300	60	28	285	726.5	18	-	-	-	-	125
PS-125 >25CV	1000	1200	3x300	60	28	285	726.5	18	-	-	125	-	125
PS-140	1100	1000	4x250	60	30	306	800	14	-	-	140	-	140
PS-160	1300	1200	4x300	60	25	290	890	14	-	-	160	-	160



MS Support frame for easier mounting on site

- Characteristics:
- Used to facilitate mounting of fan in brickwork ducts.

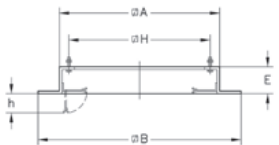

Model	ØA	ØB	E	ØH	h	Model	CHT/CVT	HT	CRF
MS-348	348	520	60	295	70	MS-348	-	-	225
MS-393	393	565	60	320	70	MS-393	-	-	250
MS-443	443	615	60	360	70	MS-443	200/225	25	315
MS-493	493	665	60	410	70	MS-493	-	31	-
MS-553	553	725	60	450	70	MS-553	250/315	35	355/400
MS-623	623	795	60	530	70	MS-623	-	40	-
MS-701	701	875	60	590	90	MS-701	400/450	45	450/500
MS-791	791	965	60	680	90	MS-791	-	50	-
MS-891	891	1065	60	750	90	MS-891	500	56	-
MS-991	991	1165	60	850	90	MS-991	-	63/71	-
MS-1086	1086	1260	60	850	90	MS-1086	560/630	-	-
MS-1140	1140	1314	60	1000	90	MS-1140	-	80/90	-
MS-1240	1240	1414	60	1100	90	MS-1240	-	100	-



PA Adjustment plate for mounting accessories, in roof-mounted extract fans

- Characteristics:
- Used to mount PT, B, BTUB, and BAC accessories. Permits the fan to be detached from its base without dismantling the accessories assembly.

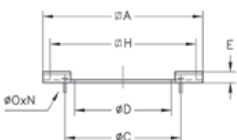

Model	ØA	ØC	ØD	E	ØH	ØO	N	Model	CHT/CVT	HT	CRF
PA-345	345	200	165	20	295	M.8	4x90"	PA-345	-	-	225
PA-390	390	210	190	20	320	M.8	4x90"	PA-390	-	-	250
PA-440/250	440	280	249	20	360	M.6	4x90"	PA-440/250	200/225	25	315
PA-490	490	355	314	20	410	M.8	8x45"	PA-490	-	31	-
PA-550	550	395	354	20	450	M.6	8x45"	PA-550	250/315	35	355/400
PA-620	620	450	399	20	530	M.10	8x45"	PA-620	-	40	-
PA-700/500	700	560	499	20	590	M.10	12x30"	PA-700/500	400/450	-	450/500
PA-700/450	700	500	449	20	590	M.10	8x45"	PA-700/450	-	45	-
PA-790	790	560	499	20	680	M.10	12x30"	PA-790	-	50	-
PA-890/630	890	690	629	20	750	M.10	12x30"	PA-890/630	500	-	-
PA-890/560	890	620	559	20	750	M.10	12x30"	PA-890/560	-	56	-
PA-990/630	990	690	629	20	850	M.10	12x30"	PA-990/630	-	63	-
PA-990/710	990	770	709	20	850	M.10	16x22"30'	PA-990/710	-	71	-
PA-1085	1085	770	709	20	850	M.10	16x22"30'	PA-1085	560/630	-	-
PA-1138/800	1138	860	799	25	1000	M.10	16x22"30'	PA-1138/800	-	80	-
PA-1138/900	1138	970	899	25	1000	M.12	16x22"30'	PA-1138/900	-	90	-
PA-1238	1238	1070	999	25	1100	M.12	16x22"30'	PA-1238	-	100	-



BS BSS

BS: Galvanised sheet steel raised support base
BSS: Galvanised sheet steel support base with silencer

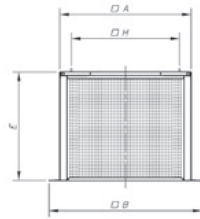

Model	A	B	H	E	CHT/CVT	HT	CRF
BS BSS-348	348	520	295	800	-	-	225
BS BSS-393	393	565	320	800	-	-	250
BS BSS-443	449	616	360	800	200/225	25	315
BS BSS-493	493	665	410	800	-	31	-
BS BSS-553	554	724	450	800	250/315	35	355/400
BS BSS-623	623	795	530	800	-	40	-
BS BSS-701	706	876	590	900	400/450	45	450/500
BS BSS-791	791	965	680	900	-	50	-
BS BSS-891	896	1076	750	900	500	56	-
BS BSS-991	991	1165	850	900	-	63/71	-
BS BSS-1086	1092	1272	900	900	560/630	-	-
BS BSS-1140	1140	1314	1000	900	-	80/90	-
BS BSS-1240	1240	1414	1100	900	-	100	-



PT PT-...-400

Self-closing plugs for vertical and horizontal work version 400, 400°C/2h-certified

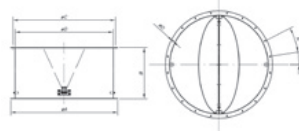

Model	ØA	B	ØC	ØD*	N	ØO	Y	CHT/CVT	CRF
PT-160	220	150	200	150	8x45°	10	-	-	225
PT-180	240	150	210	170	8x45°	10	-	-	250
PT-250	310	150	280	245	4x90°	10	45	200/225	315
PT-355	435	200	395	350	8x45°	10	22°30'	250/315	355/400
PT-500	600	280	560	495	12x30°	12	15°	400/450	450/500
PT-630	730	355	690	625	12x30°	12	15°	500	-
PT-710	810	400	770	705	16x22°30'	12	11°15'	560/630	-



PT/H PT-.../H-400

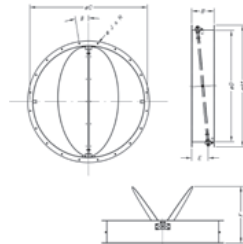

Model	ØA	B	ØC	ØD*	E	F	β	ØJ	N
PT-450/H	540	254	500	460	185	340	22°30'	12	8x45°
PT-500/H	600	254	560	514	185	346	15°	12	12x30°
PT-560/H	660	254	620	560	185	363	15°	12	12x30°
PT-630/H	730	254	690	640	185	409	15°	12	12x30°
PT-710/H	810	254	770	710	185	443	11°15'	12	16x22°30'
PT-800/H	900	254	860	800	185	488	11°15'	12	16x22°30'
PT-900/H	1015	254	970	900	185	555	11°15'	15	16x22°30'
PT-1000/H	1115	254	1070	1000	185	609	11°15'	15	16x22°30'
PT-1250/H	1365	254	1320	1250	185	736.5	9°	15	20x18°



OP

Overpressure plugs for roof-mounted extract fans

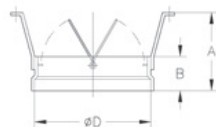

Model	A	B	ØD	Models	Model	A	B	ØD	Models
OP-25	155	75	263	HT-25	OP-45	235	85	466.5	HT-45
OP-31	171	70	311.5	HT-31	OP-50	271	85	521.5	HT-50
OP-35	190	75	363.5	HT-35	OP-56	247	50	566	HT-56
OP-40	165	75	413.5	HT-40	OP-63	259	50	647	HT-63



REG Manual regulation chamber

Characteristics:

- Due to its construction, it can be incorporated into duct systems, for flow rate adjustment.

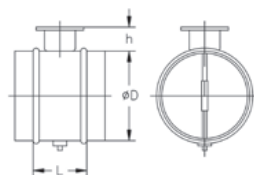

Model	L	ØD*	h	Model	L	ØD*	h
REG-80	100	80	50	REG-224	100	224	50
REG-100	100	100	50	REG-250	100	250	50
REG-112	100	112	50	REG-280	100	280	50
REG-125	100	125	50	REG-315	100	315	50
REG-140	100	140	50	REG-355	100	355	50
REG-150	100	150	50	REG-400	100	400	50
REG-160	100	160	50	REG-450	150	450	50
REG-180	100	180	50	REG-500	150	500	50
REG-200	100	200	50	REG-560	150	560	50
				REG-630	250	630	50
				REG-800	250	800	50



S Silencers for coupling to inlet or impulsion

Characteristics:

- Circular or rectangular silencers for coupling to inlet or impulsion of centrifugal or axial fans.

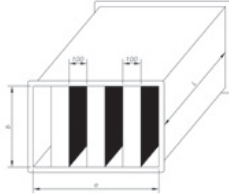

INLET / IMPULSION (Rectangular cross section)

Model	L	a	b	Kg	Substitute shock absorption (dB) in octave bands (Hz)						Applicable
					125	250	500	1000	2000	4000	
SR-1000/900/900	900	1000	900	74	4	10	21	37	44	37	HCH/HCT-63
SR-1200/900/900	900	1200	900	77	4	10	21	37	44	37	HCH/HCT-71
SR-1400/1200/900	900	1400	1200	100	4	12	25	41	47	42	HCH/HCT-80
SR-1800/1200/1200	1200	1800	1200	141	4	12	25	41	47	42	HCH/HCT-90
SR-1800/1500/1200	1200	1800	1504	168	4	12	25	41	47	42	HCH/HCT-100

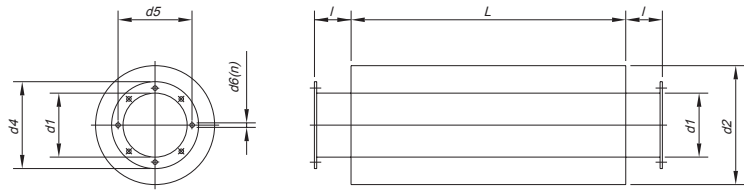

INLET / IMPULSION (Circular cross section)

Model	L	d1	d2	l	d3	d4	d5	d6	n	Kg	Substitute shock absorption (dB) in octave bands (Hz)						Applicable
											125	250	500	1000	2000	4000	
SC-630/900	900	630	800	100	630	720	690	12	12x30°	51	5	8	14	12	13	9	HCH/HCT-63
SC-710/900	900	710	900	100	710	800	770	12	16x22°30'	60	5	8	13	11	12	8	HCH/HCT-71
SC-800/900	900	800	1000	100	800	900	860	12	16x22°30'	69	4	8	11	9	9	8	HCH/HCT-80
SC-900/1200	1200	900	1120	100	900	1000	970	15	16x22°30'	100	5	7	11	11	7	5	HCH/HCT-90
SC-1000/1200	1200	1000	1200	100	1000	1100	1070	15	16x22°30'	106	4	7	11	10	7	6	HCH/HCT-100

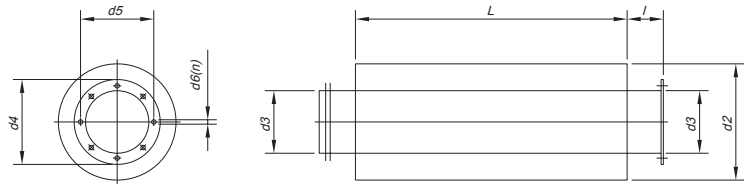

INLET

Model	L	d2	d3	d4	d5	d6	n	Kg	Substitute shock absorption (dB) in octave bands (Hz)						Applicable	
									125	250	500	1000	2000	4000		
S-160/600-A	600	260	160	220	200	10	4x90°	9	3	11	22	33	42	29		CRF-225
S-180/600-A	600	300	180	240	210	10	4x90°	11	4	8	15	31	28	20		CRF-250
S-250/600-A	600	450	250	310	280	10	4x90°	18	5	12	20	24	23	14		CHT/CVT-200/225 / HT-25 / CRF-315
S-315/900-A	900	500	315	390	355	10	8x45°	29	4	12	21	26	19	15		HT-31
S-355/900-A	900	560	355	430	395	10	8x45°	34	4	12	20	24	18	14		CHT/CVT-250/315 / HT-35 / CRF-355/400
S-400/900-A	900	600	400	480	450	12	8x45°	37	5	12	19	22	18	13		HT-40
S-450/900-A	900	630	450	530	500	12	8x45°	38	5	12	18	20	16	12		HT-45
S-500/900-A	900	710	500	590	560	12	12x30°	45	4	11	18	16	14	11		CHT/CVT-400/450 / HT-50 / CRF-450/500
S-560/900-A	900	750	560	650	620	12	12x30°	47	4	10	16	14	13	10		HT-56
S-630/900-A	900	800	630	720	690	12	12x30°	50	5	8	14	12	13	9		CHT/CVT-500 / HT-63
S-710/900-A	900	900	710	800	770	12	16x22°30'	58	5	8	13	11	12	8		CHT/CVT-560/630 HT-71
S-800/900-A	900	1000	800	900	860	12	16x22°30'	67	4	8	11	9	9	8		HT-80
S-900/1200-A	1200	1120	900	1000	970	12	16x22°30'	98	5	7	11	11	7	6		HT-90
S-1000/1200-A	1200	1200	1000	1100	1070	12	16x22°30'	103	4	7	11	10	7	6		HT-100



MOTORS Asynchronous three-phase motors

Characteristics:

- Speeds: 2, 4, 6 and 8-pole
- Three-phase power supply of 230/400V-50 Hz to 5.5 HP and 400/690V-50 Hz for higher powers.
- IM B3 (IM 1001) construction type.
- Closed motors with external ventilation (IC 411).
- IP55 protection.
- Class F insulation.
- S1 service.

On request:

- Other construction types.
- Single-phase motors.
- 2-speed motors.

Standards:

- Compliant with the following international standards:

Electrical standards

General prescriptions for rotating electrical machines
Terminal markings and direction of rotation
Starting performance of three-phase induction motors
Insulating materials
Standard voltages

IEC/EN 60034-1
IEC 60034-8
IEC 60034-12
IEC 60085
IEC 60038

Mechanical standards

Dimensions and output series
Degrees of protection (IP code)
Methods of cooling
Construction types
Noise limit values
Mechanical vibrations

IEC 60072
IEC/EN 60034-5
IEC/EN 60034-6
IEC/EN 60034-7
IEC/EN 60034-9
IEC 60034-14

3000 r/min = 2 poles 50Hz	Motor type	Power		Speed (r/min)
		(kW)	(HP)	
	MOTOR-56 1-2T	0.09	0.12	2670
	MOTOR-56 2-2T	0.12	0.16	2730
	MOTOR-63 1-2T	0.18	0.25	2710
	MOTOR-63 2-2T	0.25	0.33	2710
	MOTOR-71 1-2T	0.37	0.5	2730
	MOTOR-71 2-2T	0.55	0.75	2760
	MOTOR-80 1-2T	0.75	1	2770
	MOTOR-80 2-2T	1.1	1.5	2770
	MOTOR-90S-2T	1.5	2	2840
	MOTOR-90L-2T	2.2	3	2840
	MOTOR-100L-2T	3	4	2840
	MOTOR-112M-2T	4	5.5	2880
	MOTOR-132S 1-2T	5.5	7.5	2900
	MOTOR-132S 2-2T	7.5	10	2920
	MOTOR-160M 1-2T	11	15	2940
	MOTOR-160M 2-2T	15	20	2940
	MOTOR-160L-2T	18.5	25	2940

1500 r/min = 4 poles 50Hz	Motor type	Power		Speed (r/min)
		(kW)	(HP)	
	MOTOR-56 1-4T	0.06	0.08	1320
	MOTOR-56 2-4T	0.09	0.12	1320
	MOTOR-63 1-4T	0.12	0.17	1350
	MOTOR-63 2-4T	0.18	0.25	1350
	MOTOR-71 1-4T	0.25	0.33	1350
	MOTOR-71 2-4T	0.37	0.50	1370
	MOTOR-80 1-4T	0.55	0.75	1370
	MOTOR-80 2-4T	0.75	1.00	1380
	MOTOR-90S-4T	1.10	1.50	1400
	MOTOR-90L-4T	1.50	2.00	1400
	MOTOR-100L 1-4T	2.20	3.00	1420
	MOTOR-100L 2-4T	3.00	4.00	1420
	MOTOR-112M-4T	4.00	5.50	1430
	MOTOR-132S-4T	5.50	7.50	1450
	MOTOR-132M-4T	7.50	10.00	1450
	MOTOR-160M-4T	11.00	15.00	1460
	MOTOR-160L-4T	15.00	20.00	1460

1000 r/min = 6 poles 50Hz	Motor type	Power		Speed (r/min)
		(kW)	(HP)	
	MOTOR-71 1-6T	0.18	0.25	880
	MOTOR-71 2-6T	0.25	0.35	900
	MOTOR-80 1-6T	0.37	0.50	900
	MOTOR-80 2-6T	0.55	0.75	900
	MOTOR-90S-6T	0.75	1.00	920
	MOTOR-90L-6T	1.10	1.50	925
	MOTOR-100L-6T	1.50	2.00	945
	MOTOR-112M-6T	2.20	3.00	955
	MOTOR-132S-6T	3.00	4.00	960
	MOTOR-132M 1-6T	4.00	5.50	960
	MOTOR-132M 2-6T	5.50	7.50	960
	MOTOR-160M-6T	7.50	10.00	970
	MOTOR-160L-6T	11.00	15.00	970

750 r/min = 8 poles 50Hz	Motor type	Power		Speed (r/min)
		(kW)	(HP)	
	MOTOR-80 1-8T	0.18	0.25	680
	MOTOR-80 2-8T	0.25	0.33	680
	MOTOR-90S-8T	0.37	0.50	680
	MOTOR-90L-8T	0.55	0.75	680
	MOTOR-100L 1-8T	0.75	1.00	710
	MOTOR-100L 2-8T	1.10	1.50	710
	MOTOR-112M-8T	1.50	2.00	710
	MOTOR-132S-8T	2.20	3.00	720
	MOTOR-132M-8T	3.00	4.00	720
	MOTOR-160M 1-8T	4.00	5.50	720
	MOTOR-160M 2-8T	5.50	7.50	720
	MOTOR-160L-8T	7.50	10.00	720

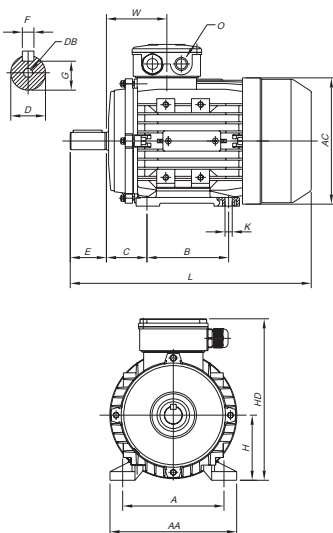

Connection diagram

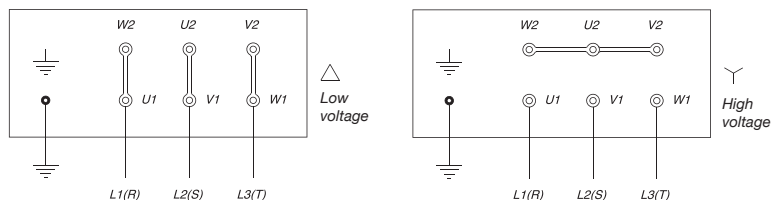

Dimensions

Model	H	A	B	C	D	E	F	G	DB	K	AA	HD	AC	L	O
56	56	90	71	36	9	20	3	7.2	M3	6x8.8	110	160	120	195	1-M16X1.5
63	63	100	80	40	11	23	4	8.5	M4	6x10	120	165	130	215	1-M16X1.5
71	71	112	90	45	14	30	5	11	M5	7x10	132	180	145	245	1-M20X1.5
80	80	125	100	50	19	40	6	15.5	M6	10x13	160	217	165	290	1-M20X1.5
90S	90	140	100	56	24	50	8	20	M8	10x13	175	230	185	310	1-M20X1.5
90L/L2	90	140	125	56	24	50	8	20	M8	10x13	175	235	185	335/365	1-M20X1.5
100	100	160	140	63	28	60	8	24	M10	12x16	196	252	205	386	1-M20X1.5
112	112	190	140	70	28	60	8	24	M10	12x16	220	292	230	395	2-M25X1.5
132/S	132	216	140	89	38	80	10	33	M12	12x16	252	330	270	436	2-M25X1.5
132M/L	132	216	178	89	38	80	10	33	M12	12x16	252	325	270	475/500	2-M25X1.5
160M	160	254	210	108	42	110	12	37	M16	15x19	335	390	320	640	2-M32X1.5
160L	160	254	254	108	42	110	12	37	M16	15x19	335	390	320	640	2-M32X1.5

CONTROL AND SENSOR UNITS



SI-PIR-TF-Cenital



SI-PIR-TF-Mural

SI-PIR

Presence sensor

Automatically activates the ventilation system on detecting the presence of people within its radius of action and continues to operate for a pre-established time, regulated by an internal clock.

Model	Power supply	Outlet	Detection angle	Adjusting devices	Installation height	Operating temperature
SI-PIR-TFT-550-B	24V AC/24 V DC	24V AC/24 V DC	110°C	5s-30 min. timer	1.8-3.6 m	-20 °C +50 °C
SI-PIR-TF-25-360	24V AC/24 V DC	24V AC/24 V DC	360°C	10s-30 min. timer	2.4-4.2 m	-20 °C +50 °C



SI-TEMP+HUMEDAD

Option: Optional temperature and humidity duct sensors.

Temperature and relative humidity sensor with display

Independently controls the temperature and relative humidity of the air inside the premises. Automatically activates the ventilation system on detecting a temperature or humidity higher than the setpoint. Once the room temperature or humidity falls below the setpoint, the fan remains on for a pre-established time, regulated by an internal clock.

Model	Power supply	Outlet	Adjusting devices	Installation height	Operating temperature
SI-TEMP+HUMEDAD	24V AC	0-10V DC	$\Delta T = 0.5 \text{ }^\circ\text{C}$ and $\Delta RH = 2\%$	1.5-2.5 m	+10 °C +40 °C



SI-PRESIÓN

Pressure transmitter

Ensures the pressure in ventilation installations remains constant and transforms it into an electrical signal to regulate the ventilation system, in order to maintain the same pressure.

Model	Power supply	Outlet	Maximum consumption (W)	Connectors	Pressure range
SI-PRESIÓN TPDA	24V AC/24 V DC	0-10V/4-20mA	4	6.2 mm	0-2500 Pa
SI-PRESIÓN TPDA WITH DISPLAY	24V AC/24 V DC	0-10V/4-20mA	4	6.2 mm	0-2500 Pa



SI TEMP IND

Proportional temperature sensor.

Model	Power supply	Outlet	Maximum consumption (W)	Operating temperature
SI-TEMP IND/P	15-24V AC $\pm 10\%$ /18-34V DC	0-10V DC/0-20 mA	1.5	0 +50 °C



SI-MF

Multifunctional sensor for controlling temperature, relative humidity and CO2.

Model	Power supply	Outlet	Maximum consumption (W)	Relative humidity range	CO2 concentration range	Operating temperature
SI_MF	24 VAC / VDC $\pm 10\%$	(0—10V DC / 0—20 mA)	3.3	0-100% RH	0-2000 ppm	0 +50 °C

CONTROL AND SENSOR UNITS



SI-FUENTE DE ALIMENTACIÓN

24V DC/AC power supply

Supplies 24 V DC/AC smart sensors through a single-phase 230 V voltage input.



Model	Power supply	Outlet	Power (W)
SI-FUENTE DE ALIMENTACIÓN DC	230 V	24 V DC	30
SI-FUENTE DE ALIMENTACIÓN AC	230/400 V	24/48 V AC	25



SI-CO2 IND

Co2 concentration sensor

Model	Power supply	Outlet	Maximum consumption (W)	CO2 concentration range	Operating temperature
SI-CO2 IND/P	15-24V AC \pm 10%/18-34V DC	0-10V DC/0-20 mA	2.5	0-2000 ppm	-10 +50 °C
SI-CO2 IND/C	15-24V AC \pm 10%/18-34V DC	0-10V DC/0-20 mA	2.5	0-2000 ppm	0 +50 °C



SI-HUMIDOSTATO

Humidity sensor.

Model	Power supply	Outlet	Maximum consumption (W)	Relative humidity range	Operating temperature
SI-HUMIDOSTATO	15-24V AC \pm 10%/18-34V DC	220-240V AC	2	0-100% RH	0 +50 °C



SI-HUMEDAD

Proportional humidity sensor.

Model	Power supply	Outlet	Maximum consumption (W)	Relative humidity range	Operating temperature
SI-HUMEDAD	15-24V AC \pm 10%/18-34V DC	0-10V DC/0-20 mA	2.5	0-100% RH	0 +50 °C



CENTRAL CO

Monoxide detection stations for ventilation control in garages.

Model	Power supply
FMC-C-501	Station for 1 zone
FMC-C-502	Station for 2 zone
FMC-C-503	Station for 3 zone
FM-M-509	Zone extension module
FM-DP500	Wall-mounted CO sensor
FM-D500	Ceiling-mounted CO sensor
FM-TC500	Converter control card



SI-VOC+HUMEDAD

Air quality, humidity and temperature sensor for 3-speed motor control.

Model	Power supply	Outlet	Maximum consumption (A)	Relative humidity range	VOC concentration range	Temperature of use
SI-VOC+HUMEDAD	230V AC	230V AC (V1, V2, V3)	2	5% RH - 95% RH	0-999 ppm	-10 +50 °C

ALPHABETICAL INDEX OF REFERENCES

FANS

CHT	149	HCT	22	HT	91
CJHCH	38	HCT/IMP	33	HTM	73
CRF	141	HCT/IMP-C	36	HTMF	100
CRF/EW/CPC	144	HEP	8	HTMH	94
CTD	153	HEPT	8	HTMV	106
CVT	149	HFW	28	HTP	40
HBA	78	HGI	89	HTTI	134
HC	12	HGT	54	RCH	156
HCD	17	HGTX	54	RCH 400X800VM	157
HCH	22	HPX	75	THT/HATCH	136
HCH/SEC	87	HPX/SEC	80	THT/ROOF	109
HCRE	19	HRE	19	TIRACANO	155

ACCESSORIES

B	163	OP	165	RI	162
BAC	164	P	162	RM	160
BS	165	P-400	162	RT	163
BSS	165	PA	164	S	166
BTUB	163	PL	162	SMART SENSORS	168
C2V	160	PS	164	VSD1/A-RFM	160
ELECTRIC CONTROL PANELS	161	PT	165	VSD3/A-RFT	160
GMP	161	PT-400	165		
INT	160	PT/H	165		
MOTORS	167	PV	163		
MS	164	R	162		
MTP	161	REG	165		



HEADQUARTER

Sodeca, S.L.U.

Pol. Ind. La Barriconca
Carrer del Metall, 2
E-17500 Ripoll
Girona, SPAIN
Tel. +34 93 852 91 11
Fax: +34 93 852 90 42
General sales:
comercial@sodeca.com
Export sales:
ventilation@sodeca.com

PRODUCTION PLANT

Sodeca, S.L.U.

Ctra. de Berga, km 0,7
E-08580 SANT QUIRZE
DE BESORA
Barcelona, SPAIN
Tel. +34 93 852 91 11
Fax: +34 93 852 90 42
General sales:
comercial@sodeca.com
Export sales:
ventilation@sodeca.com



EUROPE

FINLAND

Sodeca Finland, Oy

HUITTINEN
Sales and Warehouse
Mr. Kai Yli-Sipilä
Metsälinnankatu 30, PL2
FI-32700 Huitinen
Tel. + 358 400 320 125
orders.finland@sodeca.com

HELSINKI

Smoke Control Solutions
Mr. Antti Kontkanen
Viipulantie 9C
FI-00700 Helsinki
Tel. +358 400 237 434
akontkanen@sodeca.com

HYVINKÄÄ

Industrial Applications
Mr. Jaakko Tomperi
Niinistökatu 12
FI-05800 Hyvinkää
Tel. +358 451 651 333
jtomperi@sodeca.com

ITALIA

Marelli Ventilazione, S.R.L.

Sr. Christian Tosetti
Viale del Lavoro, 28
37036 San Martino B.A.
(VR), ITALY
Tel. +39 045 87 80 140
Fax +39 045 99 22 24
info@marelliventilazione.com

PORTUGAL

Sodeca Portugal, Unip. Lda.

PORTO
Rua Veloso Salgado 1120/1138
4450-801 Leça de Palmeira
Tel. +351 229 991 100
geral@sodeca.pt

LISBOA

Pq. Emp. da Granja Pav. 29
2625-607 Vialonga
Tel. +351 219 748 491
geral@sodeca.pt

ALGARVE

Rua da Alegria S/N
8200-557 Cortesões
Tel. +351 289 092 586
geral@sodeca.pt

UNITED KINGDOM

Sodeca Fans UK, Ltd.

Mr. Mark Newcombe
Tamworth Enterprise Centre
Philip Dix House, Corporation
Street, Tamworth, B79 7DN
UNITED KINGDOM
Tel. +44 (0) 1827 216 109
sales@sodeca.co.uk

AMERICA

CHILE

Sodeca Ventiladores, Ltda.

Sra. Sofia Ormazábal
Santa Bernardita 12.005
(Esquina con Puerta Sur)
Bodegas 24 a 26,
San Bernardo, Santiago, CHILE
Tel. +56 22 840 5582
ventas.chile@sodeca.com

COLOMBIA

Sodeca Latam, S.A.S.

Sra. Luisa Stella Prieto
Calle7 No. 13 A-44
Manzana 4 Lote1, Montana
Mosquera, Cundinamarca
Bogotá, COLOMBIA
Tel. +57 1 756 4213
ventascolombia@sodeca.com

PERU

Sodeca Perú, S.A.C.

Sr. Jose Luis Jiménez
C/ Mariscal Jose Luis de
Orbegoso 331. Urb. El pino.
15022, San Luis. Lima, PERÚ
Tel. +51 1 326 24 24
Cel. +51 994671594
comercial@sodeca.pe

RUSSIA

RUSSIA

Sodeca, L.L.C.

Mr. Stanislav Alifanov
Myasisheva str, 1, room 603
Business Center "Chaika"
140180 Zhukovskiy
Moscow region, RUSSIA
Tel. +7 495 955 90 50
alifanov@sodeca.com



HEADQUARTERS

Sodeca, S.L.U.

Pol. Ind. La Barricona
Carrer del Metall, 2
E-17500 Ripoll
Girona, SPAIN
Tel. +34 93 852 91 11
Fax +34 93 852 90 42
General sales: comercial@sodeca.com
Export sales: ventilation@sodeca.com

PRODUCTION PLANT

Sodeca, S.L.U.

Ctra. de Berga, km 0,7
E-08580 SANT QUIRZE DE BESORA
Barcelona, SPAIN
Tel. +34 93 852 91 11
Fax +34 93 852 90 42
General sales: comercial@sodeca.com
Export sales: ventilation@sodeca.com



www.sodeca.com

